

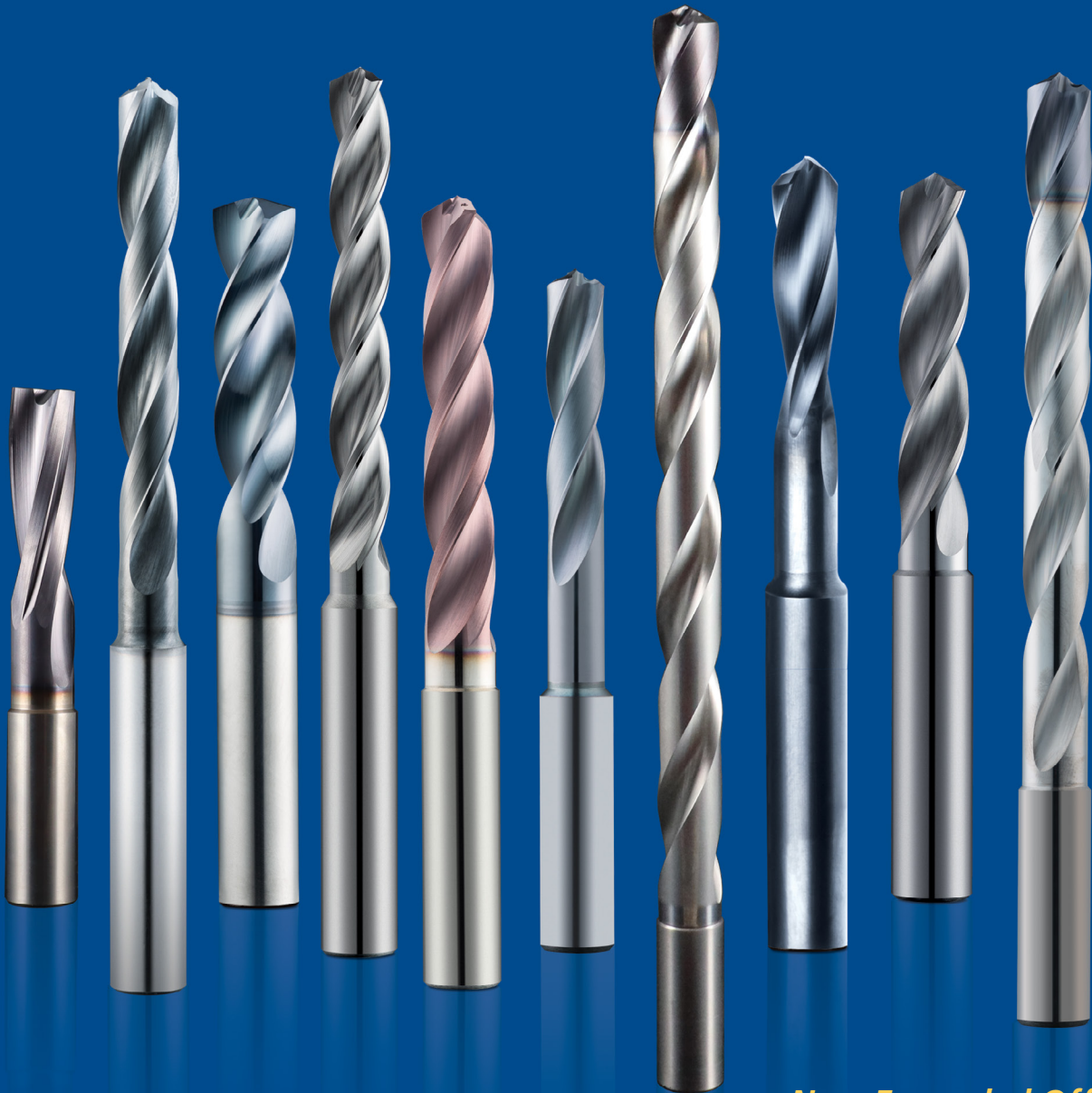

VALUE AT THE SPINDLE®

2022–2023 Drilling Solutions



New Expanded Offering

www.kyocera-sgstool.com

ISO 9001:2015 Certified



Drill Matrix

Attributes										
<p>Material hardness and machinability affect speed, feed, and cut depths.</p> <p>For dimensional and finish quality, a low TIR of the tool-holder assembly in the machine is critical: less than 0.1% drill diameter is preferred.</p> <p>Spot drilling is not necessary in most situations if the drilling surface is machined flat ; spot drill point angle should be greater than drill point angle.</p> <p>Liquid coolant (internal or external) such as oil based or synthetic is highly recommended for all drilling applications.</p> <p>For proper cooling, lubrication and chip evacuation, ensure the coolant is supplied throughout the entire depth of the hole.</p> <p>When liquid coolant cannot be applied for applications such as plastics or composites, clear the swarf with air or vacuum.</p> <p>Depending on material machinability, a peck cycle may be necessary for external coolant drills beyond 2x or 3x depths.</p>										
Diameter Range inch	Diameter Range mm	Tolerance	Length	Point Angle °	Self Centering	Flute Count	Margins	Helix Angle °	Shank	Coating
0.1250 0.7500	3,00 16,00	+ / +	3x, 5x, 8x, 12x	135	yes	2	4	30	Common	Ti-NAMITE®-X
0.1250 0.7500	3,00 16,00	+ / +	3x, 5x	135	yes	2	2	30	Common	Ti-NAMITE®-A
0.1250 0.7500	3,00 16,00	+ / +	5x	124	yes	3	3	30	Common	Ti-NAMITE®-X
0.1250 0.7500	3,00 16,00	+ / +	3x, 5x	124	yes	3	3	30	Common	Ti-NAMITE®-B
0.0980 0.5000	2,70 12,00	+ / -	3x	145, 90	yes	2	4	20	Common	Di-NAMITE®
0.0156 0.9219	1,25 22,00	+ / +	3x, 5x	145	yes	2	4	32	Common	Ti-NAMITE®-A
0.1250 0.8125	3,00 20,50	+ / +	3x, 5x	180	yes	2	4	15	Common	Ti-NAMITE®-X
0.0625 0.8125	1,50 20,50	+ / +	2x	180	yes	2	4	15	Common	Ti-NAMITE®-X

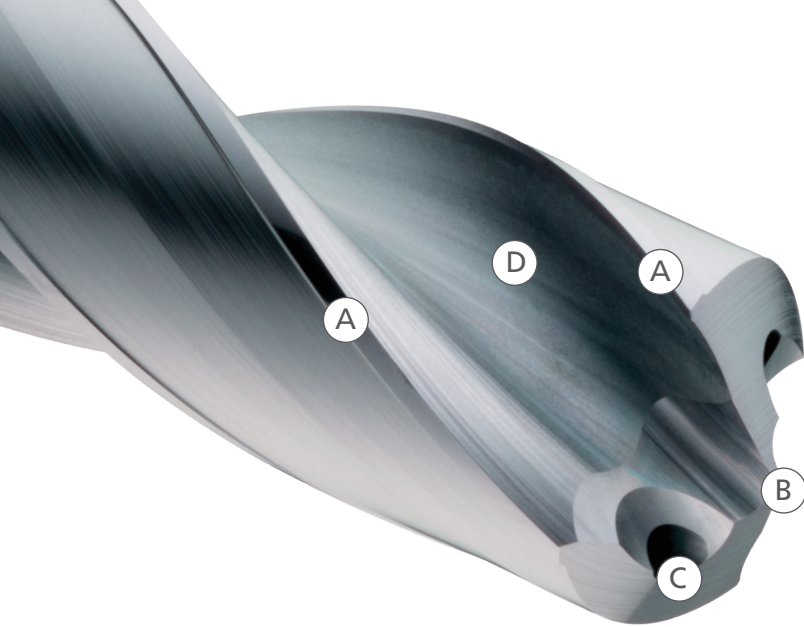

SERIES 142P



HIGH PERFORMANCE CARBIDE DRILLS

The key features designed into the Hi-PerCarb® Series 142P Drill allow the product to offer application benefits not only beyond that of standard carbide drills, but also other High Performance drills. Each feature of the Hi-PerCarb® Series 142P Drill was uniquely engineered as a solution towards addressing the issues commonly encountered during high production drilling.

- (A) 4-MARGIN DESIGN**
 - additional margin contact improves hole straightness and roundness
 - provides improved stability for difficult applications like cross holes and when exiting on an angle
- (B) POINT**
 - point design stabilizes on entry for exceptional hole size and cylindricity
 - low thrust force reduces machine power requirement and extends tool life
 - easily resharpened
- (C) COOLANT THROUGH DESIGN**
 - improves coolant flow to extend tool life and aid in chip evacuation
- (D) CARBIDE AND COATING**
 - proprietary SGS Ti-NAMITE®-X coating and certified carbide provide exceptional wear resistance and toughness for demanding applications

PERFORMANCE. PRECISION. PASSION.
HI-PERCARB® SERIES 142P DRILLS

PERFORMANCE.

TESTING PARAMETERS

- 3/8" Diameter
- 8XD Length of Cut
- 4140 Alloy Steel
- 3360 rpm
- 30 ipm
- 3.0" axial depth – blind
- TSC – Water Sol 8.9%

HOLE FINISH TEST RESULTS

The lower numerical value shown in the chart demonstrates an improved surface finish in alloy steel versus other competitors tested.

TOOL LIFE

All tools were tested until catastrophic failure, and under these conditions, the HI-PERCARB® 142P produced the most holes versus the competition.

CYLINDRICITY

CMM measurements of 14 random holes per competitor indicate the 142P cylindricity is the best among those tested.

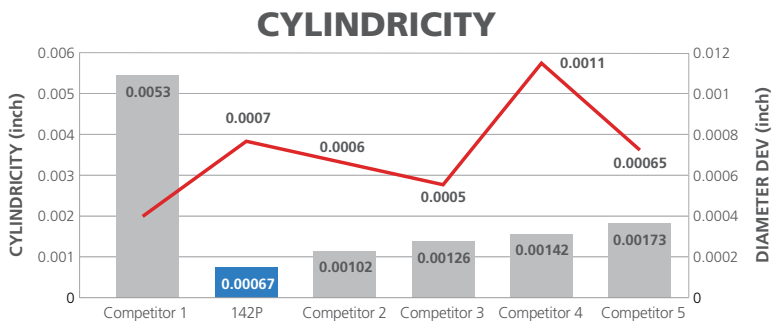
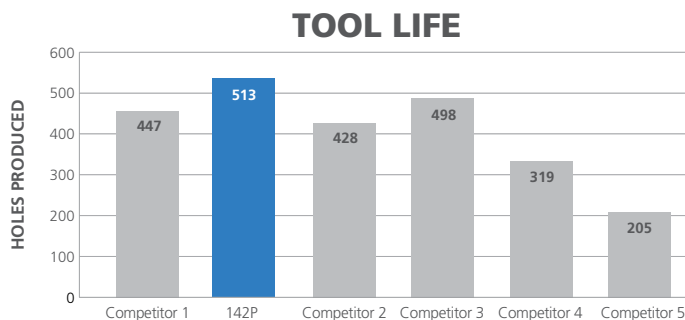
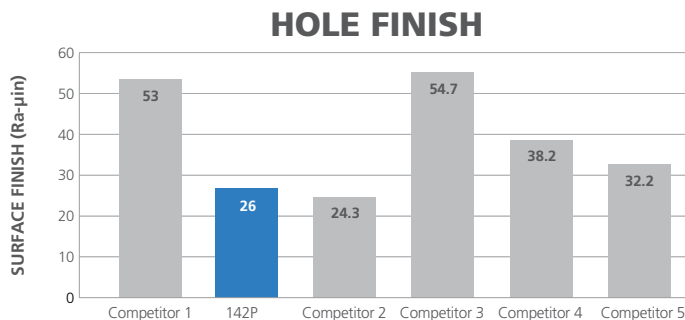

The structural design of Ti-NAMITE®-X is adapted to meet a diverse range of applications; everything from high- and low- alloy steels to hardened materials (up to 65 HRC core hardness). Ti-NAMITE®-X is suitable for operations which require high cutting speeds, high temperatures at the cutting edge, and high metal removal rates.

Hardness (HV): 3600

Oxidation Temperature: 1150°C – 2100°F

Coefficient of Friction: 0.45

Thickness: 1 – 4 Microns (based on tool diameter)

FRACTIONAL & METRIC Series 142P



142P 3xD

FRACTIONAL & METRIC SERIES

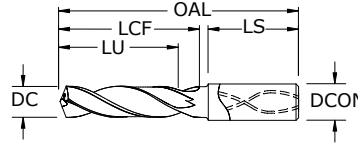

Series 142P 3xD Fractional & Metric

- High-performance point design stabilizes on entry for exceptional hole size and cylindricity while also allowing for low thrust force and extended tool life
- Internal coolant hole improves coolant flow to extend tool life and aid in chip evacuation
- 4-margin design improves hole straightness and roundness while providing improved stability for difficult applications like cross holes and when exiting on angle
- Proprietary Ti-NAMITE[®]-X coating and industry leading carbide substrate provides exceptional wear resistance and toughness for demanding applications
- Recommended for materials ≤ 50HRc (475 Bhn)

		inch & mm							EDP NO.
DECIMAL DC	METRIC DC	FRACTIONAL/ LETTER/WIRE DC	SHANK DIAMETER DCON	OVERALL LENGTH OAL	FLUTE LENGTH LCF	USABLE LENGTH LU	SHANK LENGTH LS	Ti-NAMITE [®] -X (TX)	
0.1181	3,000 mm		6,0	62,0	20,0	15,0	36,0	66400	
0.1220	3,100 mm		6,0	62,0	20,0	15,0	36,0	66401	
0.1250	3,175 mm	1/8	6,0	62,0	20,0	15,0	36,0	56400	
0.1260	3,200 mm		6,0	62,0	20,0	15,0	36,0	66402	
0.1299	3,300 mm		6,0	62,0	20,0	15,0	36,0	66403	
0.1339	3,400 mm		6,0	62,0	20,0	15,0	36,0	66404	
0.1360	3,454 mm	#29	6,0	62,0	20,0	15,0	36,0	56401	
0.1378	3,500 mm		6,0	62,0	20,0	15,0	36,0	66405	
0.1406	3,571 mm	9/64	6,0	62,0	20,0	15,0	36,0	56402	
0.1417	3,600 mm		6,0	62,0	20,0	15,0	36,0	66406	
0.1457	3,700 mm		6,0	62,0	20,0	15,0	36,0	66407	
0.1496	3,800 mm		6,0	66,0	24,0	18,0	36,0	66408	
0.1535	3,900 mm		6,0	66,0	24,0	18,0	36,0	66409	
0.1562	3,967 mm	5/32	6,0	66,0	24,0	18,0	36,0	56403	
0.1575	4,000 mm		6,0	66,0	24,0	18,0	36,0	66410	
0.1590	4,039 mm	#21	6,0	66,0	24,0	18,0	36,0	56404	
0.1614	4,100 mm		6,0	66,0	24,0	18,0	36,0	66411	
0.1654	4,200 mm		6,0	66,0	24,0	18,0	36,0	66412	
0.1693	4,300 mm		6,0	66,0	24,0	18,0	36,0	66413	
0.1719	4,366 mm	11/64	6,0	66,0	24,0	17,0	36,0	56405	
0.1732	4,400 mm		6,0	66,0	24,0	17,0	36,0	66414	
0.1772	4,500 mm		6,0	66,0	24,0	17,0	36,0	66415	
0.1811	4,600 mm		6,0	66,0	24,0	17,0	36,0	66416	
0.1850	4,699 mm	#13	6,0	66,0	24,0	17,0	36,0	66417	
0.1875	4,763 mm	3/16	6,0	66,0	28,0	21,0	36,0	56406	
0.1890	4,801 mm	#12	6,0	66,0	28,0	21,0	36,0	66418	
0.1929	4,900 mm		6,0	66,0	28,0	21,0	36,0	66419	
0.1969	5,000 mm		6,0	66,0	28,0	20,0	36,0	66420	
0.2008	5,100 mm		6,0	66,0	28,0	20,0	36,0	66421	
0.2031	5,159 mm	13/64	6,0	66,0	28,0	20,0	36,0	56407	
0.2047	5,200 mm		6,0	66,0	28,0	20,0	36,0	66422	
0.2087	5,300 mm		6,0	66,0	28,0	20,0	36,0	66423	
0.2126	5,400 mm		6,0	66,0	28,0	20,0	36,0	66424	
0.2165	5,500 mm		6,0	66,0	28,0	20,0	36,0	66425	
0.2188	5,558 mm	7/32	6,0	66,0	28,0	20,0	36,0	56408	
0.2205	5,600 mm		6,0	66,0	28,0	20,0	36,0	66426	
0.2244	5,700 mm		6,0	66,0	28,0	19,0	36,0	66427	
0.2283	5,800 mm		6,0	66,0	28,0	19,0	36,0	66428	
0.2323	5,900 mm		6,0	66,0	28,0	19,0	36,0	66429	
0.2344	5,954 mm	15/64	6,0	66,0	28,0	19,0	36,0	56409	
0.2362	6,000 mm		6,0	66,0	28,0	19,0	36,0	66430	
0.2402	6,100 mm		8,0	79,0	34,0	25,0	36,0	66431	
0.2441	6,200 mm		8,0	79,0	34,0	25,0	36,0	66432	
0.2480	6,300 mm		8,0	79,0	34,0	25,0	36,0	66433	
0.2500	6,350 mm	1/4 E #0	8,0	79,0	34,0	24,0	36,0	56410	
0.2520	6,400 mm		8,0	79,0	34,0	24,0	36,0	66434	

TOLERANCES (inch)

≤.1181 DIAMETER

DC = +.0008/+0.0047
DCON = h₆

>.1181-.2362 DIAMETER

DC = +.00016/+0.00063
DCON = h₆

>.2362-.3937 DIAMETER

DC = +.00024/+0.00083
DCON = h₆

>.3937-.7087 DIAMETER

DC = +.00028/+0.00098
DCON = h₆

>.7087-1.1811 DIAMETER

DC = +.00031/+0.00114
DCON = h₆

TOLERANCES (mm)

≤3 DIAMETER

DC = +0,002/+0,012
DCON = h₆

>3-6 DIAMETER

DC = +0,004/+0,016
DCON = h₆

>6-10 DIAMETER

DC = +0,006/+0,021
DCON = h₆

>10-18 DIAMETER

DC = +0,007/+0,025
DCON = h₆

>18-30 DIAMETER

DC = +0,008/+0,029
DCON = h₆

- STEELS
- STAINLESS STEELS
- CAST IRON
- NON-FERROUS
- HIGH TEMP ALLOYS
- HARDENED STEELS

For patent information visit www.kspatents.com

continued on next page



FRACTIONAL & METRIC Series 142P

142P 3xD

FRACTIONAL & METRIC SERIES

DECIMAL DC	METRIC DC	inch & mm						EDP NO.
		FRACTIONAL/ LETTER/WIRE DC	SHANK DIAMETER DCON	OVERALL LENGTH OAL	FLUTE LENGTH LCF	USABLE LENGTH LU	SHANK LENGTH LS	Ti-NAMITE®-X (TX)
0.2559	6,500 mm		8,0	79,0	34,0	24,0	36,0	66435
0.2570	6,528 mm	F	8,0	79,0	34,0	24,0	36,0	56411
0.2598	6,600 mm		8,0	79,0	34,0	24,0	36,0	66436
0.2638	6,700 mm		8,0	79,0	34,0	24,0	36,0	66437
0.2656	6,746 mm	17/64	8,0	79,0	34,0	24,0	36,0	56412
0.2677	6,800 mm		8,0	79,0	34,0	24,0	36,0	66438
0.2717	6,900 mm		8,0	79,0	34,0	24,0	36,0	66439
0.2756	7,000 mm		8,0	79,0	34,0	24,0	36,0	66440
0.2795	7,100 mm		8,0	79,0	41,0	30,0	36,0	66441
0.2812	7,142 mm	9/32	8,0	79,0	41,0	30,0	36,0	56413
0.2835	7,200 mm		8,0	79,0	41,0	30,0	36,0	66442
0.2874	7,300 mm		8,0	79,0	41,0	30,0	36,0	66443
0.2913	7,400 mm		8,0	79,0	41,0	30,0	36,0	66444
0.2953	7,500 mm		8,0	79,0	41,0	30,0	36,0	66445
0.2969	7,541 mm	19/64	8,0	79,0	41,0	30,0	36,0	56414
0.2992	7,600 mm		8,0	79,0	41,0	30,0	36,0	66446
0.3031	7,700 mm		8,0	79,0	41,0	29,0	36,0	66447
0.3071	7,800 mm		8,0	79,0	41,0	29,0	36,0	66448
0.3110	7,900 mm		8,0	79,0	41,0	29,0	36,0	66449
0.3125	7,938 mm	5/16	8,0	79,0	41,0	29,0	36,0	56415
0.3150	8,000 mm		8,0	79,0	41,0	29,0	36,0	66450
0.3189	8,100 mm		10,0	89,0	47,0	35,0	40,0	66451
0.3228	8,200 mm		10,0	89,0	47,0	35,0	40,0	66452
0.3268	8,300 mm		10,0	89,0	47,0	35,0	40,0	66453
0.3281	8,334 mm	21/64	10,0	89,0	47,0	34,0	40,0	56416
0.3307	8,400 mm		10,0	89,0	47,0	34,0	40,0	66454
0.3320	8,433 mm	Q	10,0	89,0	47,0	34,0	40,0	56417
0.3346	8,500 mm		10,0	89,0	47,0	34,0	40,0	66455
0.3386	8,600 mm		10,0	89,0	47,0	34,0	40,0	66456
0.3425	8,700 mm		10,0	89,0	47,0	34,0	40,0	66457
0.3438	8,733 mm	11/32	10,0	89,0	47,0	34,0	40,0	56418
0.3465	8,800 mm		10,0	89,0	47,0	34,0	40,0	66458
0.3504	8,900 mm		10,0	89,0	47,0	34,0	40,0	66459
0.3543	9,000 mm		10,0	89,0	47,0	34,0	40,0	66460
0.3583	9,100 mm		10,0	89,0	47,0	33,0	40,0	66461
0.3594	9,129 mm	23/64	10,0	89,0	47,0	33,0	40,0	56419
0.3622	9,200 mm		10,0	89,0	47,0	33,0	40,0	66462
0.3661	9,300 mm		10,0	89,0	47,0	33,0	40,0	66463
0.3680	9,347 mm	U	10,0	89,0	47,0	33,0	40,0	56420
0.3701	9,400 mm		10,0	89,0	47,0	33,0	40,0	66464
0.3740	9,500 mm		10,0	89,0	47,0	33,0	40,0	66465
0.3750	9,525 mm	3/8	10,0	89,0	47,0	33,0	40,0	56421
0.3780	9,600 mm		10,0	89,0	47,0	33,0	40,0	66466
0.3819	9,700 mm		10,0	89,0	47,0	32,0	40,0	66467
0.3858	9,800 mm		10,0	89,0	47,0	32,0	40,0	66468
0.3898	9,900 mm		10,0	89,0	47,0	32,0	40,0	66469
0.3906	9,921 mm	25/64	10,0	89,0	47,0	32,0	40,0	56422
0.3937	10,000 mm		10,0	89,0	47,0	32,0	40,0	66470
0.3976	10,100 mm		12,0	102,0	55,0	40,0	45,0	66471
0.4016	10,200 mm		12,0	102,0	55,0	40,0	45,0	66472
0.4055	10,300 mm		12,0	102,0	55,0	40,0	45,0	66473
0.4062	10,317 mm	13/32	12,0	102,0	55,0	40,0	45,0	56423
0.4095	10,400 mm		12,0	102,0	55,0	39,0	45,0	66474
0.4134	10,500 mm		12,0	102,0	55,0	39,0	45,0	66475

continued on next page

CONTINUED

Series 142P 3xD | Fractional & Metric

FRACTIONAL & METRIC Series 142P



142P 3xD

FRACTIONAL & METRIC SERIES

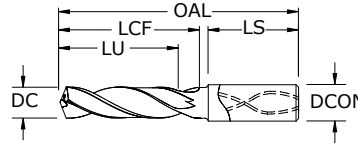

Series 142P 3xD Fractional & Metric

- High-performance point design stabilizes on entry for exceptional hole size and cylindricity while also allowing for low thrust force and extended tool life
- Internal coolant hole improves coolant flow to extend tool life and aid in chip evacuation
- 4-margin design improves hole straightness and roundness while providing improved stability for difficult applications like cross holes and when exiting on angle
- Proprietary Ti-NAMITE[®]-X coating and industry leading carbide substrate provides exceptional wear resistance and toughness for demanding applications
- Recommended for materials ≤ 50HRc (475 Bhn)

inch & mm									EDP NO.
DECIMAL DC	METRIC DC	FRACTIONAL/ LETTER/WIRE DC	SHANK DIAMETER DCON	OVERALL LENGTH OAL	FLUTE LENGTH LCF	USABLE LENGTH LU	SHANK LENGTH LS		Ti-NAMITE [®] -X (TX)
0.4173	10,600 mm		12,0	102,0	55,0	39,0	45,0		66476
0.4213	10,700 mm		12,0	102,0	55,0	39,0	45,0		66477
0.4219	10,716 mm	27/64	12,0	102,0	55,0	39,0	45,0		56424
0.4252	10,800 mm		12,0	102,0	55,0	39,0	45,0		66478
0.4291	10,900 mm		12,0	102,0	55,0	39,0	45,0		66479
0.4331	11,000 mm		12,0	102,0	55,0	39,0	45,0		66480
0.4370	11,100 mm		12,0	102,0	55,0	38,0	45,0		66481
0.4375	11,113 mm	7/16	12,0	102,0	55,0	38,0	45,0		56425
0.4409	11,200 mm		12,0	102,0	55,0	38,0	45,0		66482
0.4449	11,300 mm		12,0	102,0	55,0	38,0	45,0		66483
0.4488	11,400 mm		12,0	102,0	55,0	38,0	45,0		66484
0.4528	11,500 mm		12,0	102,0	55,0	38,0	45,0		66485
0.4567	11,600 mm		12,0	102,0	55,0	38,0	45,0		66486
0.4606	11,700 mm		12,0	102,0	55,0	37,0	45,0		66487
0.4646	11,800 mm		12,0	102,0	55,0	37,0	45,0		66488
0.4685	11,900 mm		12,0	102,0	55,0	37,0	45,0		66489
0.4688	11,908 mm	15/32	12,0	102,0	55,0	37,0	45,0		56426
0.4724	12,000 mm		12,0	102,0	55,0	37,0	45,0		66490
0.4844	12,304 mm	31/64	14,0	107,0	60,0	41,0	45,0		56427
0.4921	12,500 mm		14,0	107,0	60,0	41,0	45,0		66491
0.5000	12,700 mm	1/2	14,0	107,0	60,0	41,0	45,0		56428
0.5039	12,800 mm		14,0	107,0	60,0	41,0	45,0		66492
0.5118	13,000 mm		14,0	107,0	60,0	41,0	45,0		66493
0.5156	13,096 mm	33/64	14,0	107,0	60,0	40,0	45,0		56429
0.5315	13,500 mm		14,0	107,0	60,0	40,0	45,0		66494
0.5433	13,800 mm		14,0	107,0	60,0	39,0	45,0		66495
0.5512	14,000 mm		14,0	107,0	60,0	39,0	45,0		66496
0.5625	14,288 mm	9/16	16,0	115,0	65,0	43,0	48,0		56430
0.5709	14,500 mm		16,0	115,0	65,0	43,0	48,0		66497
0.5781	14,684 mm	37/64	16,0	115,0	65,0	43,0	48,0		56431
0.5827	14,800 mm		16,0	115,0	65,0	43,0	48,0		66498
0.5906	15,000 mm		16,0	115,0	65,0	42,0	48,0		66499
0.6102	15,500 mm		16,0	115,0	65,0	42,0	48,0		66500
0.6221	15,800 mm		16,0	115,0	65,0	41,0	48,0		66501
0.6250	15,875 mm	5/8	16,0	115,0	65,0	41,0	48,0		56432
0.6299	16,000 mm		16,0	115,0	65,0	41,0	48,0		66502
0.6562	16,667 mm	21/32	18,0	123,0	73,0	47,0	48,0		56433
0.6875	17,463 mm	11/16	18,0	123,0	73,0	47,0	48,0		56434
0.7500	19,050 mm	3/4	20,0	131,0	79,0	50,0	50,0		56435

TOLERANCES (inch)

≤.1181 DIAMETER

DC = +.00008/+0.00047
DCON = h₆

>.1181-.2362 DIAMETER

DC = +.00016/+0.00063
DCON = h₆

>.2362-.3937 DIAMETER

DC = +.00024/+0.00083
DCON = h₆

>.3937-.7087 DIAMETER

DC = +.00028/+0.00098
DCON = h₆

>.7087-1.1811 DIAMETER

DC = +.00031/+0.00114
DCON = h₆

TOLERANCES (mm)

≤3 DIAMETER

DC = +0,002/+0,012
DCON = h₆

>3-6 DIAMETER

DC = +0,004/+0,016
DCON = h₆

>6-10 DIAMETER

DC = +0,006/+0,021
DCON = h₆

>10-18 DIAMETER

DC = +0,007/+0,025
DCON = h₆

>18-30 DIAMETER

DC = +0,008/+0,029
DCON = h₆

- STEELS
- STAINLESS STEELS
- CAST IRON
- NON-FERROUS
- HIGH TEMP ALLOYS
- HARDENED STEELS

For patent information visit www.ksptpatents.com

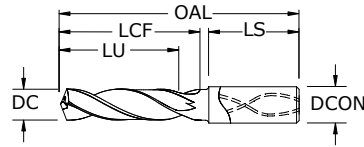
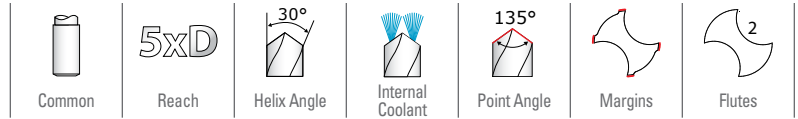

142P 5xD
FRACTIONAL & METRIC SERIES

TOLERANCES (inch)

- ≤.1181 DIAMETER**
DC = +.00008/+0.00047
DCON = h₆
- >.1181-.2362 DIAMETER**
DC = +.00016/+0.00063
DCON = h₆
- >.2362-.3937 DIAMETER**
DC = +.00024/+0.00083
DCON = h₆
- >.3937-.7087 DIAMETER**
DC = +.00028/+0.00098
DCON = h₆
- >.7087-1.1811 DIAMETER**
DC = +.00031/+0.00114
DCON = h₆

TOLERANCES (mm)

- ≤3 DIAMETER**
DC = +0,002/+0,012
DCON = h₆
- >3-6 DIAMETER**
DC = +0,004/+0,016
DCON = h₆
- >6-10 DIAMETER**
DC = +0,006/+0,021
DCON = h₆
- >10-18 DIAMETER**
DC = +0,007/+0,025
DCON = h₆
- >18-30 DIAMETER**
DC = +0,008/+0,029
DCON = h₆

- STEELS**
- STAINLESS STEELS**
- CAST IRON**
- NON-FERROUS**
- HIGH TEMP ALLOYS**
- HARDENED STEELS**

For patent information visit www.ksptpatents.com

inch & mm									EDP NO.
DECIMAL DC	METRIC DC	FRACTIONAL/ LETTER/WIRE DC	SHANK DIAMETER DCON	OVERALL LENGTH OAL	FLUTE LENGTH LCF	USABLE LENGTH LU	SHANK LENGTH LS	Ti-NAMITE®-X (TX)	
0.1181	3,000 mm		6,0	66,0	28,0	23,0	36,0	66503	
0.1220	3,100 mm		6,0	66,0	28,0	23,0	36,0	66504	
0.1250	3,175 mm	1/8	6,0	66,0	28,0	23,0	36,0	56436	
0.1260	3,200 mm		6,0	66,0	28,0	23,0	36,0	66505	
0.1299	3,300 mm		6,0	66,0	28,0	23,0	36,0	66506	
0.1339	3,400 mm		6,0	66,0	28,0	23,0	36,0	66507	
0.1360	3,454 mm	#29	6,0	66,0	28,0	23,0	36,0	56437	
0.1378	3,500 mm		6,0	66,0	28,0	23,0	36,0	66508	
0.1406	3,571 mm	9/64	6,0	66,0	28,0	23,0	36,0	56438	
0.1417	3,600 mm		6,0	66,0	28,0	23,0	36,0	66509	
0.1457	3,700 mm		6,0	66,0	28,0	23,0	36,0	66510	
0.1496	3,800 mm		6,0	74,0	36,0	29,0	36,0	66511	
0.1535	3,900 mm		6,0	74,0	36,0	29,0	36,0	66512	
0.1562	3,967 mm	5/32	6,0	74,0	36,0	29,0	36,0	56439	
0.1575	4,000 mm		6,0	74,0	36,0	29,0	36,0	66513	
0.1590	4,039 mm	#21	6,0	74,0	36,0	29,0	36,0	56440	
0.1614	4,100 mm		6,0	74,0	36,0	29,0	36,0	66514	
0.1654	4,200 mm		6,0	74,0	36,0	29,0	36,0	66515	
0.1693	4,300 mm		6,0	74,0	36,0	29,0	36,0	66516	
0.1719	4,366 mm	11/64	6,0	74,0	36,0	29,0	36,0	56441	
0.1732	4,400 mm		6,0	74,0	36,0	29,0	36,0	66517	
0.1772	4,500 mm		6,0	74,0	36,0	29,0	36,0	66518	
0.1811	4,600 mm		6,0	74,0	36,0	29,0	36,0	66519	
0.1850	4,699 mm	#13	6,0	74,0	36,0	29,0	36,0	66520	
0.1875	4,763 mm	3/16	6,0	82,0	44,0	37,0	36,0	56442	
0.1890	4,801 mm	#12	6,0	82,0	44,0	37,0	36,0	66521	
0.1929	4,900 mm		6,0	82,0	44,0	37,0	36,0	66522	
0.1969	5,000 mm		6,0	82,0	44,0	36,0	36,0	66523	
0.2008	5,100 mm		6,0	82,0	44,0	36,0	36,0	66524	
0.2031	5,159 mm	13/64	6,0	82,0	44,0	36,0	36,0	56443	
0.2047	5,200 mm		6,0	82,0	44,0	36,0	36,0	66525	
0.2087	5,300 mm		6,0	82,0	44,0	36,0	36,0	66526	
0.2126	5,400 mm		6,0	82,0	44,0	36,0	36,0	66527	
0.2165	5,500 mm		6,0	82,0	44,0	36,0	36,0	66528	
0.2188	5,558 mm	7/32	6,0	82,0	44,0	36,0	36,0	56444	
0.2205	5,600 mm		6,0	82,0	44,0	36,0	36,0	66529	
0.2244	5,700 mm		6,0	82,0	44,0	35,0	36,0	66530	
0.2283	5,800 mm		6,0	82,0	44,0	35,0	36,0	66531	
0.2323	5,900 mm		6,0	82,0	44,0	35,0	36,0	66532	
0.2344	5,954 mm	15/64	6,0	82,0	44,0	35,0	36,0	56445	
0.2362	6,000 mm		6,0	82,0	44,0	35,0	36,0	66533	
0.2402	6,100 mm		8,0	91,0	53,0	44,0	36,0	66534	
0.2441	6,200 mm		8,0	91,0	53,0	44,0	36,0	66535	
0.2480	6,300 mm		8,0	91,0	53,0	44,0	36,0	66536	

- High-performance point design stabilizes on entry for exceptional hole size and cylindricity while also allowing for low thrust force and extended tool life
- Internal coolant hole improves coolant flow to extend tool life and aid in chip evacuation
- 4-margin design improves hole straightness and roundness while providing improved stability for difficult applications like cross holes and when exiting on angle
- Proprietary Ti-NAMITE®-X coating and industry leading carbide substrate provides exceptional wear resistance and toughness for demanding applications
- Recommended for materials ≤ 50HRc (475 Bhn)

continued on next page

FRACTIONAL & METRIC Series 142P



142P 5xD

FRACTIONAL & METRIC SERIES

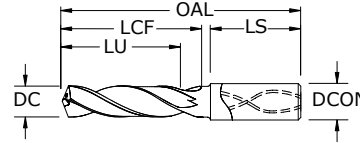

Series 142P 5xD Fractional & Metric

- High-performance point design stabilizes on entry for exceptional hole size and cylindricity while also allowing for low thrust force and extended tool life
- Internal coolant hole improves coolant flow to extend tool life and aid in chip evacuation
- 4-margin design improves hole straightness and roundness while providing improved stability for difficult applications like cross holes and when exiting on angle
- Proprietary Ti-NAMITE[®]-X coating and industry leading carbide substrate provides exceptional wear resistance and toughness for demanding applications
- Recommended for materials ≤ 50HRc (475 Bhn)

		inch & mm							EDP NO.
DECIMAL DC	METRIC DC	FRACTIONAL/ LETTER/WIRE DC	SHANK DIAMETER DCON	OVERALL LENGTH OAL	FLUTE LENGTH LCF	USABLE LENGTH LU	SHANK LENGTH LS	Ti-NAMITE [®] -X (TX)	
0.2500	6,350 mm	1/4 E #0	8,0	91,0	53,0	43,0	36,0	56446	
0.2520	6,400 mm		8,0	91,0	53,0	43,0	36,0	66537	
0.2559	6,500 mm		8,0	91,0	53,0	43,0	36,0	66538	
0.2570	6,528 mm	F	8,0	91,0	53,0	43,0	36,0	56447	
0.2598	6,600 mm		8,0	91,0	53,0	43,0	36,0	66539	
0.2638	6,700 mm		8,0	91,0	53,0	43,0	36,0	66540	
0.2656	6,746 mm	17/64	8,0	91,0	53,0	43,0	36,0	56448	
0.2677	6,800 mm		8,0	91,0	53,0	43,0	36,0	66541	
0.2717	6,900 mm		8,0	91,0	53,0	43,0	36,0	66542	
0.2756	7,000 mm		8,0	91,0	53,0	42,0	36,0	66543	
0.2795	7,100 mm		8,0	91,0	53,0	42,0	36,0	66544	
0.2812	7,142 mm	9/32	8,0	91,0	53,0	42,0	36,0	56449	
0.2835	7,200 mm		8,0	91,0	53,0	42,0	36,0	66545	
0.2874	7,300 mm		8,0	91,0	53,0	42,0	36,0	66546	
0.2913	7,400 mm		8,0	91,0	53,0	42,0	36,0	66547	
0.2953	7,500 mm		8,0	91,0	53,0	42,0	36,0	66548	
0.2969	7,541 mm	19/64	8,0	91,0	53,0	42,0	36,0	56450	
0.2992	7,600 mm		8,0	91,0	53,0	42,0	36,0	66549	
0.3031	7,700 mm		8,0	91,0	53,0	41,0	36,0	66550	
0.3071	7,800 mm		8,0	91,0	53,0	41,0	36,0	66551	
0.3110	7,900 mm		8,0	91,0	53,0	41,0	36,0	66552	
0.3125	7,938 mm	5/16	8,0	91,0	53,0	41,0	36,0	56451	
0.3150	8,000 mm		8,0	91,0	53,0	41,0	36,0	66553	
0.3189	8,100 mm		10,0	103,0	61,0	49,0	40,0	66554	
0.3228	8,200 mm		10,0	103,0	61,0	49,0	40,0	66555	
0.3268	8,300 mm		10,0	103,0	61,0	49,0	40,0	66556	
0.3281	8,334 mm	21/64	10,0	103,0	61,0	48,0	40,0	56452	
0.3307	8,400 mm		10,0	103,0	61,0	48,0	40,0	66557	
0.3320	8,433 mm	Q	10,0	103,0	61,0	48,0	40,0	56453	
0.3346	8,500 mm		10,0	103,0	61,0	48,0	40,0	66558	
0.3386	8,600 mm		10,0	103,0	61,0	48,0	40,0	66559	
0.3425	8,700 mm		10,0	103,0	61,0	48,0	40,0	66560	
0.3438	8,733 mm	11/32	10,0	103,0	61,0	48,0	40,0	56454	
0.3465	8,800 mm		10,0	103,0	61,0	48,0	40,0	66561	
0.3504	8,900 mm		10,0	103,0	61,0	48,0	40,0	66562	
0.3543	9,000 mm		10,0	103,0	61,0	48,0	40,0	66563	
0.3583	9,100 mm		10,0	103,0	61,0	47,0	40,0	66564	
0.3594	9,129 mm	23/64	10,0	103,0	61,0	47,0	40,0	56455	
0.3622	9,200 mm		10,0	103,0	61,0	47,0	40,0	66565	
0.3661	9,300 mm		10,0	103,0	61,0	47,0	40,0	66566	
0.3680	9,347 mm	U	10,0	103,0	61,0	47,0	40,0	56456	
0.3701	9,400 mm		10,0	103,0	61,0	47,0	40,0	66567	
0.3740	9,500 mm		10,0	103,0	61,0	47,0	40,0	66568	
0.3750	9,525 mm	3/8	10,0	103,0	61,0	47,0	40,0	56457	

TOLERANCES (inch)

- ≤.1181 DIAMETER
DC = +.0008/+0.0047
DCON = h₆
- >.1181-.2362 DIAMETER
DC = +.00016/+0.00063
DCON = h₆
- >.2362-.3937 DIAMETER
DC = +.00024/+0.00083
DCON = h₆
- >.3937-.7087 DIAMETER
DC = +.00028/+0.00098
DCON = h₆
- >.7087-1.1811 DIAMETER
DC = +.00031/+0.00114
DCON = h₆

TOLERANCES (mm)

- ≤3 DIAMETER
DC = +0,002/+0,012
DCON = h₆
- >3-6 DIAMETER
DC = +0,004/+0,016
DCON = h₆
- >6-10 DIAMETER
DC = +0,006/+0,021
DCON = h₆
- >10-18 DIAMETER
DC = +0,007/+0,025
DCON = h₆
- >18-30 DIAMETER
DC = +0,008/+0,029
DCON = h₆

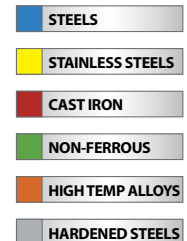

For patent information visit www.ksptpatents.com

continued on next page

www.kyocera-sgstoool.com



FRACTIONAL & METRIC Series 142P

142P 5xD

FRACTIONAL & METRIC SERIES

DECIMAL DC	METRIC DC	inch & mm						EDP NO.
		FRACTIONAL/ LETTER/WIRE DC	SHANK DIAMETER DCON	OVERALL LENGTH OAL	FLUTE LENGTH LCF	USABLE LENGTH LU	SHANK LENGTH LS	Ti-NAMITE [®] -X (TX)
0.3780	9,600 mm		10,0	103,0	61,0	47,0	40,0	66569
0.3819	9,700 mm		10,0	103,0	61,0	46,0	40,0	66570
0.3858	9,800 mm		10,0	103,0	61,0	46,0	40,0	66571
0.3898	9,900 mm		10,0	103,0	61,0	46,0	40,0	66572
0.3906	9,921 mm	25/64	10,0	103,0	61,0	46,0	40,0	56458
0.3937	10,000 mm		10,0	103,0	61,0	46,0	40,0	66573
0.3976	10,100 mm		12,0	118,0	71,0	56,0	45,0	66574
0.4016	10,200 mm		12,0	118,0	71,0	56,0	45,0	66575
0.4055	10,300 mm		12,0	118,0	71,0	56,0	45,0	66576
0.4062	10,317 mm	13/32	12,0	118,0	71,0	56,0	45,0	56459
0.4095	10,400 mm		12,0	118,0	71,0	55,0	45,0	66577
0.4134	10,500 mm		12,0	118,0	71,0	55,0	45,0	66578
0.4173	10,600 mm		12,0	118,0	71,0	55,0	45,0	66579
0.4213	10,700 mm		12,0	118,0	71,0	55,0	45,0	66580
0.4219	10,716 mm	27/64	12,0	118,0	71,0	55,0	45,0	56460
0.4252	10,800 mm		12,0	118,0	71,0	55,0	45,0	66581
0.4291	10,900 mm		12,0	118,0	71,0	55,0	45,0	66582
0.4331	11,000 mm		12,0	118,0	71,0	54,0	45,0	66583
0.4370	11,100 mm		12,0	118,0	71,0	54,0	45,0	66584
0.4375	11,113 mm	7/16	12,0	118,0	71,0	54,0	45,0	56461
0.4409	11,200 mm		12,0	118,0	71,0	54,0	45,0	66585
0.4449	11,300 mm		12,0	118,0	71,0	54,0	45,0	66586
0.4488	11,400 mm		12,0	118,0	71,0	54,0	45,0	66587
0.4528	11,500 mm		12,0	118,0	71,0	54,0	45,0	66588
0.4567	11,600 mm		12,0	118,0	71,0	54,0	45,0	66589
0.4606	11,700 mm		12,0	118,0	71,0	53,0	45,0	66590
0.4646	11,800 mm		12,0	118,0	71,0	53,0	45,0	66591
0.4685	11,900 mm		12,0	118,0	71,0	53,0	45,0	66592
0.4688	11,908 mm	15/32	12,0	118,0	71,0	53,0	45,0	56462
0.4724	12,000 mm		12,0	118,0	71,0	53,0	45,0	66593
0.4844	12,304 mm	31/64	14,0	124,0	77,0	58,0	45,0	56463
0.4921	12,500 mm		14,0	124,0	77,0	58,0	45,0	66594
0.5000	12,700 mm	1/2	14,0	124,0	77,0	58,0	45,0	56464
0.5039	12,800 mm		14,0	124,0	77,0	58,0	45,0	66595
0.5118	13,000 mm		14,0	124,0	77,0	58,0	45,0	66596
0.5156	13,096 mm	33/64	14,0	124,0	77,0	57,0	45,0	56465
0.5315	13,500 mm		14,0	124,0	77,0	57,0	45,0	66597
0.5433	13,800 mm		14,0	124,0	77,0	56,0	45,0	66598
0.5512	14,000 mm		14,0	124,0	77,0	56,0	45,0	66599
0.5625	14,288 mm	9/16	16,0	133,0	83,0	61,0	48,0	56466
0.5709	14,500 mm		16,0	133,0	83,0	61,0	48,0	66600
0.5781	14,684 mm	37/64	16,0	133,0	83,0	61,0	48,0	56467
0.5827	14,800 mm		16,0	133,0	83,0	61,0	48,0	66601
0.5906	15,000 mm		16,0	133,0	83,0	60,0	48,0	66602
0.6102	15,500 mm		16,0	133,0	83,0	60,0	48,0	66603
0.6221	15,800 mm		16,0	133,0	83,0	59,0	48,0	66604
0.6250	15,875 mm	5/8	16,0	133,0	83,0	59,0	48,0	56468
0.6299	16,000 mm		16,0	133,0	83,0	59,0	48,0	66605
0.6562	16,667 mm	21/32	18,0	143,0	93,0	68,0	48,0	56469
0.6875	17,463 mm	11/16	18,0	143,0	93,0	67,0	48,0	56470
0.7500	19,050 mm	3/4	20,0	153,0	101,0	72,0	50,0	56471

CONTINUED

Series 142P 5xD | Fractional & Metric

FRACTIONAL & METRIC Series 142P



142P 8xD

FRACTIONAL & METRIC SERIES

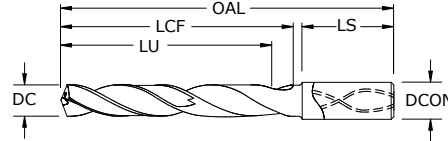

Series 142P 8xD Fractional & Metric

- High-performance point design stabilizes on entry for exceptional hole size and cylindricity while also allowing for low thrust force and extended tool life
- Internal coolant hole improves coolant flow to extend tool life and aid in chip evacuation
- 4-margin design improves hole straightness and roundness while providing improved stability for difficult applications like cross holes and when exiting on angle
- Proprietary Ti-NAMITE[®]-X coating and industry leading carbide substrate provides exceptional wear resistance and toughness for demanding applications
- Recommended for materials ≤ 50HRc (475 Bhn)

		inch & mm							EDP NO.
DECIMAL DC	METRIC DC	FRACTIONAL/ LETTER/WIRE DC	SHANK DIAMETER DCON	OVERALL LENGTH OAL	FLUTE LENGTH LCF	USABLE LENGTH LU	SHANK LENGTH LS	Ti-NAMITE [®] -X (TX)	
0.1181	3,000 mm		6,0	72,0	34,0	29,0	36,0	66606	
0.1220	3,100 mm		6,0	72,0	34,0	29,0	36,0	66607	
0.1250	3,175 mm	1/8	6,0	72,0	34,0	29,0	36,0	56472	
0.1260	3,200 mm		6,0	72,0	34,0	29,0	36,0	66608	
0.1299	3,300 mm		6,0	72,0	34,0	29,0	36,0	66609	
0.1339	3,400 mm		6,0	72,0	34,0	29,0	36,0	66610	
0.1360	3,454 mm	#29	6,0	72,0	34,0	29,0	36,0	56473	
0.1378	3,500 mm		6,0	72,0	34,0	29,0	36,0	66611	
0.1406	3,571 mm	9/64	6,0	72,0	34,0	29,0	36,0	56474	
0.1417	3,600 mm		6,0	72,0	34,0	29,0	36,0	66612	
0.1457	3,700 mm		6,0	72,0	34,0	29,0	36,0	66613	
0.1496	3,800 mm		6,0	81,0	43,0	37,0	36,0	66614	
0.1535	3,900 mm		6,0	81,0	43,0	37,0	36,0	66615	
0.1562	3,967 mm	5/32	6,0	81,0	43,0	37,0	36,0	56475	
0.1575	4,000 mm		6,0	81,0	43,0	37,0	36,0	66616	
0.1590	4,039 mm	#21	6,0	81,0	43,0	37,0	36,0	56476	
0.1614	4,100 mm		6,0	81,0	43,0	37,0	36,0	66617	
0.1654	4,200 mm		6,0	81,0	43,0	37,0	36,0	66618	
0.1693	4,300 mm		6,0	81,0	43,0	37,0	36,0	66619	
0.1719	4,366 mm	11/64	6,0	81,0	43,0	36,0	36,0	56477	
0.1732	4,400 mm		6,0	81,0	43,0	36,0	36,0	66620	
0.1772	4,500 mm		6,0	81,0	43,0	36,0	36,0	66621	
0.1811	4,600 mm		6,0	81,0	43,0	36,0	36,0	66622	
0.1850	4,699 mm	#13	6,0	81,0	43,0	36,0	36,0	66623	
0.1875	4,763 mm	3/16	6,0	95,0	57,0	50,0	36,0	56478	
0.1890	4,801 mm	#12	6,0	95,0	57,0	50,0	36,0	66624	
0.1929	4,900 mm		6,0	95,0	57,0	50,0	36,0	66625	
0.1969	5,000 mm		6,0	95,0	57,0	49,0	36,0	66626	
0.2008	5,100 mm		6,0	95,0	57,0	49,0	36,0	66627	
0.2031	5,159 mm	13/64	6,0	95,0	57,0	49,0	36,0	56479	
0.2047	5,200 mm		6,0	95,0	57,0	49,0	36,0	66628	
0.2087	5,300 mm		6,0	95,0	57,0	49,0	36,0	66629	
0.2126	5,400 mm		6,0	95,0	57,0	49,0	36,0	66630	
0.2165	5,500 mm		6,0	95,0	57,0	49,0	36,0	66631	
0.2188	5,558 mm	7/32	6,0	95,0	57,0	49,0	36,0	56480	
0.2205	5,600 mm		6,0	95,0	57,0	49,0	36,0	66632	
0.2244	5,700 mm		6,0	95,0	57,0	48,0	36,0	66633	
0.2283	5,800 mm		6,0	95,0	57,0	48,0	36,0	66634	

TOLERANCES (inch)

≤.1181 DIAMETER

DC = +.0008/+0.0047
DCON = h₆

>.1181-.2362 DIAMETER

DC = +.00016/+0.00063
DCON = h₆

>.2362-.3937 DIAMETER

DC = +.00024/+0.00083
DCON = h₆

>.3937-.7087 DIAMETER

DC = +.00028/+0.00098
DCON = h₆

>.7087-1.1811 DIAMETER

DC = +.00031/+0.00114
DCON = h₆

TOLERANCES (mm)

≤3 DIAMETER

DC = +0,002/+0,012
DCON = h₆

>3-6 DIAMETER

DC = +0,004/+0,016
DCON = h₆

>6-10 DIAMETER

DC = +0,006/+0,021
DCON = h₆

>10-18 DIAMETER

DC = +0,007/+0,025
DCON = h₆

>18-30 DIAMETER

DC = +0,008/+0,029
DCON = h₆

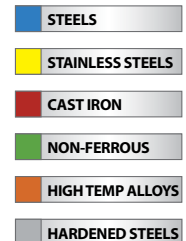

continued on next page

For patent information visit www.ksptpatents.com



FRACTIONAL & METRIC Series 142P

142P 8xD

FRACTIONAL & METRIC SERIES

DECIMAL DC	METRIC DC	inch & mm						EDP NO. Ti-NAMITE®-X (TX)
		FRACTIONAL/ LETTER/WIRE DC	SHANK DIAMETER DCON	OVERALL LENGTH OAL	FLUTE LENGTH LCF	USABLE LENGTH LU	SHANK LENGTH LS	
0.2323	5,900 mm		6,0	95,0	57,0	48,0	36,0	66635
0.2344	5,954 mm	15/64	6,0	95,0	57,0	48,0	36,0	56481
0.2362	6,000 mm		6,0	95,0	57,0	48,0	36,0	66636
0.2402	6,100 mm		8,0	114,0	76,0	67,0	36,0	66637
0.2441	6,200 mm		8,0	114,0	76,0	67,0	36,0	66638
0.2480	6,300 mm		8,0	114,0	76,0	67,0	36,0	66639
0.2500	6,350 mm	1/4 E #0	8,0	114,0	76,0	66,0	36,0	56482
0.2520	6,400 mm		8,0	114,0	76,0	66,0	36,0	66640
0.2559	6,500 mm		8,0	114,0	76,0	66,0	36,0	66641
0.2570	6,528 mm	F	8,0	114,0	76,0	66,0	36,0	56483
0.2598	6,600 mm		8,0	114,0	76,0	66,0	36,0	66642
0.2638	6,700 mm		8,0	114,0	76,0	66,0	36,0	66643
0.2656	6,746 mm	17/64	8,0	114,0	76,0	66,0	36,0	56484
0.2677	6,800 mm		8,0	114,0	76,0	66,0	36,0	66644
0.2717	6,900 mm		8,0	114,0	76,0	66,0	36,0	66645
0.2756	7,000 mm		8,0	114,0	76,0	65,0	36,0	66646
0.2795	7,100 mm		8,0	114,0	76,0	65,0	36,0	66647
0.2812	7,142 mm	9/32	8,0	114,0	76,0	65,0	36,0	56485
0.2835	7,200 mm		8,0	114,0	76,0	65,0	36,0	66648
0.2874	7,300 mm		8,0	114,0	76,0	65,0	36,0	66649
0.2913	7,400 mm		8,0	114,0	76,0	65,0	36,0	66650
0.2953	7,500 mm		8,0	114,0	76,0	65,0	36,0	66651
0.2969	7,541 mm	19/64	8,0	114,0	76,0	65,0	36,0	56486
0.2992	7,600 mm		8,0	114,0	76,0	65,0	36,0	66652
0.3031	7,700 mm		8,0	114,0	76,0	64,0	36,0	66653
0.3071	7,800 mm		8,0	114,0	76,0	64,0	36,0	66654
0.3110	7,900 mm		8,0	114,0	76,0	64,0	36,0	66655
0.3125	7,938 mm	5/16	8,0	114,0	76,0	64,0	36,0	56487
0.3150	8,000 mm		8,0	114,0	76,0	64,0	36,0	66656
0.3189	8,100 mm		10,0	142,0	95,0	83,0	40,0	66657
0.3228	8,200 mm		10,0	142,0	95,0	83,0	40,0	66658
0.3268	8,300 mm		10,0	142,0	95,0	83,0	40,0	66659
0.3281	8,334 mm	21/64	10,0	142,0	95,0	83,0	40,0	56488
0.3307	8,400 mm		10,0	142,0	95,0	82,0	40,0	66660
0.3320	8,433 mm	Q	10,0	142,0	95,0	82,0	40,0	56489
0.3346	8,500 mm		10,0	142,0	95,0	82,0	40,0	66661
0.3386	8,600 mm		10,0	142,0	95,0	82,0	40,0	66662
0.3425	8,700 mm		10,0	142,0	95,0	82,0	40,0	66663
0.3438	8,733 mm	11/32	10,0	142,0	95,0	82,0	40,0	56490
0.3465	8,800 mm		10,0	142,0	95,0	82,0	40,0	66664
0.3504	8,900 mm		10,0	142,0	95,0	82,0	40,0	66665
0.3543	9,000 mm		10,0	142,0	95,0	82,0	40,0	66666
0.3583	9,100 mm		10,0	142,0	95,0	81,0	40,0	66667
0.3594	9,129 mm	23/64	10,0	142,0	95,0	81,0	40,0	56491

continued on next page

CONTINUED

Series 142P 8xD | Fractional & Metric

FRACTIONAL & METRIC Series 142P



142P 8xD

FRACTIONAL & METRIC SERIES

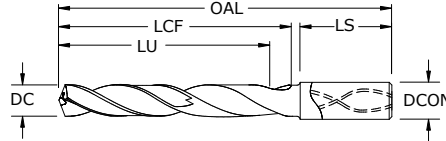

- High-performance point design stabilizes on entry for exceptional hole size and cylindricity while also allowing for low thrust force and extended tool life
- Internal coolant hole improves coolant flow to extend tool life and aid in chip evacuation
- 4-margin design improves hole straightness and roundness while providing improved stability for difficult applications like cross holes and when exiting on angle
- Proprietary Ti-NAMITE®-X coating and industry leading carbide substrate provides exceptional wear resistance and toughness for demanding applications
- Recommended for materials ≤ 50HRc (475 Bhn)

		inch & mm							EDP NO.
DECIMAL DC	METRIC DC	FRACTIONAL/ LETTER/WIRE DC	SHANK DIAMETER DCON	OVERALL LENGTH OAL	FLUTE LENGTH LCF	USABLE LENGTH LU	SHANK LENGTH LS	Ti-NAMITE®-X (TX)	
0.3622	9,200 mm		10,0	142,0	95,0	81,0	40,0	66668	
0.3661	9,300 mm		10,0	142,0	95,0	81,0	40,0	66669	
0.3680	9,347 mm	U	10,0	142,0	95,0	81,0	40,0	56492	
0.3701	9,400 mm		10,0	142,0	95,0	81,0	40,0	66670	
0.3740	9,500 mm		10,0	142,0	95,0	81,0	40,0	66671	
0.3750	9,525 mm	3/8	10,0	142,0	95,0	81,0	40,0	56493	
0.3780	9,600 mm		10,0	142,0	95,0	81,0	40,0	66672	
0.3819	9,700 mm		10,0	142,0	95,0	80,0	40,0	66673	
0.3858	9,800 mm		10,0	142,0	95,0	80,0	40,0	66674	
0.3898	9,900 mm		10,0	142,0	95,0	80,0	40,0	66675	
0.3906	9,921 mm	25/64	10,0	142,0	95,0	80,0	40,0	56494	
0.3937	10,000 mm		10,0	142,0	95,0	80,0	40,0	66676	
0.3976	10,100 mm		12,0	162,0	114,0	99,0	45,0	66677	
0.4016	10,200 mm		12,0	162,0	114,0	99,0	45,0	66678	
0.4055	10,300 mm		12,0	162,0	114,0	99,0	45,0	66679	
0.4062	10,317 mm	13/32	12,0	162,0	114,0	99,0	45,0	56495	
0.4095	10,400 mm		12,0	162,0	114,0	98,0	45,0	66680	
0.4134	10,500 mm		12,0	162,0	114,0	98,0	45,0	66681	
0.4173	10,600 mm		12,0	162,0	114,0	98,0	45,0	66682	
0.4213	10,700 mm		12,0	162,0	114,0	98,0	45,0	66683	
0.4219	10,716 mm	27/64	12,0	162,0	114,0	98,0	45,0	56496	
0.4252	10,800 mm		12,0	162,0	114,0	98,0	45,0	66684	
0.4291	10,900 mm		12,0	162,0	114,0	98,0	45,0	66685	
0.4331	11,000 mm		12,0	162,0	114,0	97,0	45,0	66686	
0.4370	11,100 mm		12,0	162,0	114,0	97,0	45,0	66687	
0.4375	11,113 mm	7/16	12,0	162,0	114,0	97,0	45,0	56497	
0.4409	11,200 mm		12,0	162,0	114,0	97,0	45,0	66688	
0.4449	11,300 mm		12,0	162,0	114,0	97,0	45,0	66689	
0.4488	11,400 mm		12,0	162,0	114,0	97,0	45,0	66690	
0.4528	11,500 mm		12,0	162,0	114,0	97,0	45,0	66691	
0.4567	11,600 mm		12,0	162,0	114,0	97,0	45,0	66692	
0.4606	11,700 mm		12,0	162,0	114,0	96,0	45,0	66693	
0.4646	11,800 mm		12,0	162,0	114,0	96,0	45,0	66694	
0.4685	11,900 mm		12,0	162,0	114,0	96,0	45,0	66695	
0.4688	11,908 mm	15/32	12,0	162,0	114,0	96,0	45,0	56498	
0.4724	12,000 mm		12,0	162,0	114,0	96,0	45,0	66696	
0.4844	12,304 mm	31/64	14,0	178,0	133,0	114,0	45,0	56499	
0.4921	12,500 mm		14,0	178,0	133,0	114,0	45,0	66697	

TOLERANCES (inch)

≤.1181 DIAMETER

DC = +.0008/+0.0047
DCON = h₆

>.1181-.2362 DIAMETER

DC = +.00016/+0.00063
DCON = h₆

>.2362-.3937 DIAMETER

DC = +.00024/+0.00083
DCON = h₆

>.3937-.7087 DIAMETER

DC = +.00028/+0.00098
DCON = h₆

>.7087-1.1811 DIAMETER

DC = +.00031/+0.00114
DCON = h₆

TOLERANCES (mm)

≤3 DIAMETER

DC = +0,002/+0,012
DCON = h₆

>3-6 DIAMETER

DC = +0,004/+0,016
DCON = h₆

>6-10 DIAMETER

DC = +0,006/+0,021
DCON = h₆

>10-18 DIAMETER

DC = +0,007/+0,025
DCON = h₆

>18-30 DIAMETER

DC = +0,008/+0,029
DCON = h₆

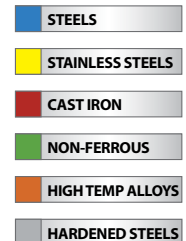

For patent information visit www.kspatents.com

continued on next page



FRACTIONAL & METRIC Series 142P

142P 8xD

FRACTIONAL & METRIC SERIES

DECIMAL DC	METRIC DC	inch & mm						EDP NO.
		FRACTIONAL/ LETTER/WIRE DC	SHANK DIAMETER DCON	OVERALL LENGTH OAL	FLUTE LENGTH LCF	USABLE LENGTH LU	SHANK LENGTH LS	Ti-NAMITE®-X (TX)
0.5000	12,700 mm	1/2	14,0	178,0	133,0	114,0	45,0	56500
0.5039	12,800 mm		14,0	178,0	133,0	114,0	45,0	66698
0.5118	13,000 mm		14,0	178,0	133,0	114,0	45,0	66699
0.5156	13,096 mm	33/64	14,0	178,0	133,0	113,0	45,0	56501
0.5315	13,500 mm		14,0	178,0	133,0	113,0	45,0	66700
0.5433	13,800 mm		14,0	178,0	133,0	113,0	45,0	66701
0.5512	14,000 mm		14,0	178,0	133,0	113,0	45,0	66702
0.5625	14,288 mm	9/16	16,0	203,0	152,0	130,0	48,0	56502
0.5709	14,500 mm		16,0	203,0	152,0	130,0	48,0	66703
0.5781	14,684 mm	37/64	16,0	203,0	152,0	130,0	48,0	56503
0.5827	14,800 mm		16,0	203,0	152,0	130,0	48,0	66704
0.5906	15,000 mm		16,0	203,0	152,0	129,0	48,0	66705
0.6102	15,500 mm		16,0	203,0	152,0	129,0	48,0	66706
0.6221	15,800 mm		16,0	203,0	152,0	128,0	48,0	66707
0.6250	15,875 mm	5/8	16,0	203,0	152,0	128,0	48,0	56504
0.6299	16,000 mm		16,0	203,0	152,0	128,0	48,0	66708
0.6562	16,667 mm	21/32	18,0	222,0	171,0	145,0	48,0	56505
0.6875	17,463 mm	11/16	18,0	222,0	171,0	145,0	48,0	56506
0.7500	19,050 mm	3/4	20,0	243,0	190,0	161,0	50,0	56507

CONTINUED

Series 142P 8xD | Fractional & Metric

FRACTIONAL & METRIC Series 142P



New Expanded Tools

142P 12xD FRACTIONAL & METRIC SERIES

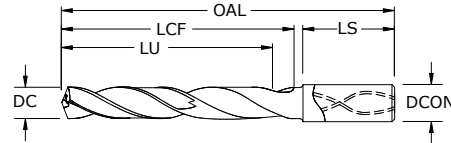

Series 142P 12xD Fractional & Metric

- High-performance point design stabilizes on entry for exceptional hole size and cylindricity while also allowing for low thrust force and extended tool life
- Internal coolant hole improves coolant flow to extend tool life and aid in chip evacuation
- 4-margin design improves hole straightness and roundness while providing improved stability for difficult applications like cross holes and when exiting on angle
- Proprietary Ti-NAMITE[®]-X coating and industry leading carbide substrate provides exceptional wear resistance and toughness for demanding applications
- Recommended for materials ≤ 50HRc (475 Bhn)

DECIMAL DC	METRIC DC	inch & mm		OVERALL LENGTH OAL	FLUTE LENGTH LCF	USABLE LENGTH LU	SHANK LENGTH LS	EDP NO.
		FRACTIONAL/ LETTER/WIRE DC	SHANK DIAMETER DCON					
0.1181	3,000 mm		6,0	87,0	49,0	44,0	36,0	66709
0.1220	3,100 mm		6,0	87,0	49,0	44,0	36,0	66710
0.1250	3,175 mm	1/8	6,0	87,0	49,0	44,0	36,0	56508
0.1260	3,200 mm		6,0	87,0	49,0	44,0	36,0	66711
0.1299	3,300 mm		6,0	87,0	49,0	44,0	36,0	66712
0.1339	3,400 mm		6,0	87,0	49,0	44,0	36,0	66713
0.1360	3,454 mm	#29	6,0	87,0	49,0	44,0	36,0	56509
0.1378	3,500 mm		6,0	87,0	49,0	44,0	36,0	66714
0.1406	3,571 mm	9/64	6,0	87,0	49,0	43,0	36,0	56510
0.1417	3,600 mm		6,0	87,0	49,0	43,0	36,0	66715
0.1457	3,700 mm		6,0	87,0	49,0	43,0	36,0	66716
0.1496	3,800 mm		6,0	100,0	62,0	56,0	36,0	66717
0.1535	3,900 mm		6,0	100,0	62,0	56,0	36,0	66718
0.1562	3,967 mm	5/32	6,0	100,0	62,0	56,0	36,0	56511
0.1575	4,000 mm		6,0	100,0	62,0	56,0	36,0	66719
0.1590	4,039 mm	#21	6,0	100,0	62,0	56,0	36,0	56512
0.1614	4,100 mm		6,0	100,0	62,0	56,0	36,0	66720
0.1654	4,200 mm		6,0	100,0	62,0	55,0	36,0	66721
0.1693	4,300 mm		6,0	100,0	62,0	55,0	36,0	66722
0.1719	4,366 mm	11/64	6,0	100,0	62,0	55,0	36,0	56513
0.1732	4,400 mm		6,0	100,0	62,0	55,0	36,0	66723
0.1772	4,500 mm		6,0	100,0	62,0	55,0	36,0	66724
0.1811	4,600 mm		6,0	100,0	62,0	55,0	36,0	66725
0.1850	4,699 mm	#13	6,0	100,0	62,0	55,0	36,0	66726
0.1875	4,763 mm	3/16	6,0	119,0	81,0	74,0	36,0	56514
0.1890	4,801 mm	#12	6,0	119,0	81,0	74,0	36,0	66727
0.1929	4,900 mm		6,0	119,0	81,0	74,0	36,0	66728
0.1969	5,000 mm		6,0	119,0	81,0	73,0	36,0	66729
0.2008	5,100 mm		6,0	119,0	81,0	73,0	36,0	66730
0.2031	5,159 mm	13/64	6,0	119,0	81,0	73,0	36,0	56515
0.2047	5,200 mm		6,0	119,0	81,0	73,0	36,0	66731
0.2087	5,300 mm		6,0	119,0	81,0	73,0	36,0	66732
0.2126	5,400 mm		6,0	119,0	81,0	73,0	36,0	66733
0.2165	5,500 mm		6,0	119,0	81,0	73,0	36,0	66734
0.2188	5,558 mm	7/32	6,0	119,0	81,0	73,0	36,0	56516
0.2205	5,600 mm		6,0	119,0	81,0	73,0	36,0	66735
0.2244	5,700 mm		6,0	119,0	81,0	72,0	36,0	66736
0.2283	5,800 mm		6,0	119,0	81,0	72,0	36,0	66737

TOLERANCES (inch)

- ≤.1181 DIAMETER
DC = +.0008/+0.0047
DCON = h₆
- >.1181-.2362 DIAMETER
DC = +.00016/+0.00063
DCON = h₆
- >.2362-.3937 DIAMETER
DC = +.00024/+0.00083
DCON = h₆
- >.3937-.7087 DIAMETER
DC = +.00028/+0.00098
DCON = h₆
- >.7087-1.1811 DIAMETER
DC = +.00031/+0.00114
DCON = h₆

TOLERANCES (mm)

- ≤3 DIAMETER
DC = +0,002/+0,012
DCON = h₆
- >3-6 DIAMETER
DC = +0,004/+0,016
DCON = h₆
- >6-10 DIAMETER
DC = +0,006/+0,021
DCON = h₆
- >10-18 DIAMETER
DC = +0,007/+0,025
DCON = h₆
- >18-30 DIAMETER
DC = +0,008/+0,029
DCON = h₆

- STEELS
- STAINLESS STEELS
- CAST IRON
- NON-FERROUS
- HIGH TEMP ALLOYS
- HARDENED STEELS

continued on next page

For patent information visit www.kspatents.com



FRACTIONAL & METRIC Series 142P

142P 12xD FRACTIONAL & METRIC SERIES

DECIMAL DC	METRIC DC	inch & mm						EDP NO.
		FRACTIONAL/ LETTER/WIRE DC	SHANK DIAMETER DCON	OVERALL LENGTH OAL	FLUTE LENGTH LCF	USABLE LENGTH LU	SHANK LENGTH LS	
0.2323	5,900 mm		6,0	119,0	81,0	72,0	36,0	66738
0.2344	5,954 mm	15/64	6,0	119,0	81,0	72,0	36,0	56517
0.2362	6,000 mm		6,0	119,0	81,0	72,0	36,0	66739
0.2402	6,100 mm		8,0	146,0	108,0	99,0	36,0	66740
0.2441	6,200 mm		8,0	146,0	108,0	99,0	36,0	66741
0.2480	6,300 mm		8,0	146,0	108,0	99,0	36,0	66742
0.2500	6,350 mm	1/4 E #0	8,0	146,0	108,0	98,0	36,0	56518
0.2520	6,400 mm		8,0	146,0	108,0	98,0	36,0	66743
0.2559	6,500 mm		8,0	146,0	108,0	98,0	36,0	66744
0.2570	6,528 mm	F	8,0	146,0	108,0	98,0	36,0	56519
0.2598	6,600 mm		8,0	146,0	108,0	98,0	36,0	66745
0.2638	6,700 mm		8,0	146,0	108,0	98,0	36,0	66746
0.2656	6,746 mm	17/64	8,0	146,0	108,0	98,0	36,0	56520
0.2677	6,800 mm		8,0	146,0	108,0	98,0	36,0	66747
0.2717	6,900 mm		8,0	146,0	108,0	98,0	36,0	66748
0.2756	7,000 mm		8,0	146,0	108,0	97,0	36,0	66749
0.2795	7,100 mm		8,0	146,0	108,0	97,0	36,0	66750
0.2812	7,142 mm	9/32	8,0	146,0	108,0	97,0	36,0	56521
0.2835	7,200 mm		8,0	146,0	108,0	97,0	36,0	66751
0.2874	7,300 mm		8,0	146,0	108,0	97,0	36,0	66752
0.2913	7,400 mm		8,0	146,0	108,0	97,0	36,0	66753
0.2953	7,500 mm		8,0	146,0	108,0	97,0	36,0	66754
0.2969	7,541 mm	19/64	8,0	146,0	108,0	97,0	36,0	56522
0.2992	7,600 mm		8,0	146,0	108,0	97,0	36,0	66755
0.3031	7,700 mm		8,0	146,0	108,0	96,0	36,0	66756
0.3071	7,800 mm		8,0	146,0	108,0	96,0	36,0	66757
0.3110	7,900 mm		8,0	146,0	108,0	96,0	36,0	66758
0.3125	7,938 mm	5/16	8,0	146,0	108,0	96,0	36,0	56523
0.3150	8,000 mm		8,0	146,0	108,0	96,0	36,0	66759
0.3189	8,100 mm		10,0	182,0	135,0	123,0	40,0	66760
0.3228	8,200 mm		10,0	182,0	135,0	123,0	40,0	66761
0.3268	8,300 mm		10,0	182,0	135,0	123,0	40,0	66762
0.3281	8,334 mm	21/64	10,0	182,0	135,0	123,0	40,0	56524
0.3307	8,400 mm		10,0	182,0	135,0	122,0	40,0	66763
0.3320	8,433 mm	Q	10,0	182,0	135,0	122,0	40,0	56525
0.3346	8,500 mm		10,0	182,0	135,0	122,0	40,0	66764
0.3386	8,600 mm		10,0	182,0	135,0	122,0	40,0	66765
0.3425	8,700 mm		10,0	182,0	135,0	122,0	40,0	66766
0.3438	8,733 mm	11/32	10,0	182,0	135,0	122,0	40,0	56526
0.3465	8,800 mm		10,0	182,0	135,0	122,0	40,0	66767
0.3504	8,900 mm		10,0	182,0	135,0	122,0	40,0	66768
0.3543	9,000 mm		10,0	182,0	135,0	122,0	40,0	66769
0.3583	9,100 mm		10,0	182,0	135,0	121,0	40,0	66770
0.3594	9,129 mm	23/64	10,0	182,0	135,0	121,0	40,0	56527

continued on next page

CONTINUED

Series 142P 12xD | Fractional & Metric

FRACTIONAL & METRIC Series 142P

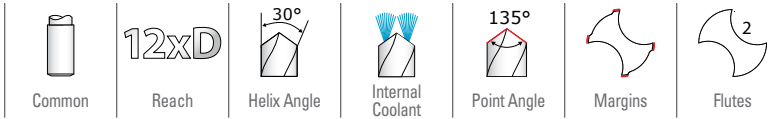

New Expanded Tools

142P 12xD

FRACTIONAL & METRIC SERIES

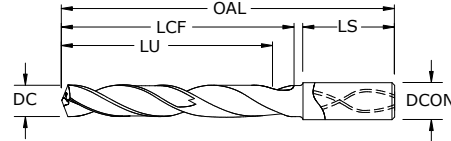

Series 142P 12xD Fractional & Metric

- High-performance point design stabilizes on entry for exceptional hole size and cylindricity while also allowing for low thrust force and extended tool life
- Internal coolant hole improves coolant flow to extend tool life and aid in chip evacuation
- 4-margin design improves hole straightness and roundness while providing improved stability for difficult applications like cross holes and when exiting on angle
- Proprietary Ti-NAMITE[®]-X coating and industry leading carbide substrate provides exceptional wear resistance and toughness for demanding applications
- Recommended for materials ≤ 50HRc (475 Bhn)

		inch & mm						EDP NO.
DECIMAL DC	METRIC DC	FRACTIONAL/ LETTER/WIRE DC	SHANK DIAMETER DCON	OVERALL LENGTH OAL	FLUTE LENGTH LCF	USABLE LENGTH LU	SHANK LENGTH LS	Ti-NAMITE [®] -X (TX)
0.3622	9,200 mm		10,0	182,0	135,0	121,0	40,0	66771
0.3661	9,300 mm		10,0	182,0	135,0	121,0	40,0	66772
0.3680	9,347 mm	U	10,0	182,0	135,0	121,0	40,0	56528
0.3701	9,400 mm		10,0	182,0	135,0	121,0	40,0	66773
0.3740	9,500 mm		10,0	182,0	135,0	121,0	40,0	66774
0.3750	9,525 mm	3/8	10,0	182,0	135,0	121,0	40,0	56529
0.3780	9,600 mm		10,0	182,0	135,0	121,0	40,0	66775
0.3819	9,700 mm		10,0	182,0	135,0	120,0	40,0	66776
0.3858	9,800 mm		10,0	182,0	135,0	120,0	40,0	66777
0.3898	9,900 mm		10,0	182,0	135,0	120,0	40,0	66778
0.3906	9,921 mm	25/64	10,0	182,0	135,0	120,0	40,0	56530
0.3937	10,000 mm		10,0	182,0	135,0	120,0	40,0	66779
0.3976	10,100 mm		12,0	210,0	162,0	147,0	45,0	66780
0.4016	10,200 mm		12,0	210,0	162,0	147,0	45,0	66781
0.4055	10,300 mm		12,0	210,0	162,0	147,0	45,0	66782
0.4062	10,317 mm	13/32	12,0	210,0	162,0	147,0	45,0	56531
0.4095	10,400 mm		12,0	210,0	162,0	146,0	45,0	66783
0.4134	10,500 mm		12,0	210,0	162,0	146,0	45,0	66784
0.4173	10,600 mm		12,0	210,0	162,0	146,0	45,0	66785
0.4213	10,700 mm		12,0	210,0	162,0	146,0	45,0	66786
0.4219	10,716 mm	27/64	12,0	210,0	162,0	146,0	45,0	56532
0.4252	10,800 mm		12,0	210,0	162,0	146,0	45,0	66787
0.4291	10,900 mm		12,0	210,0	162,0	146,0	45,0	66788
0.4331	11,000 mm		12,0	210,0	162,0	145,0	45,0	66789
0.4370	11,100 mm		12,0	210,0	162,0	145,0	45,0	66790
0.4375	11,113 mm	7/16	12,0	210,0	162,0	145,0	45,0	56533
0.4409	11,200 mm		12,0	210,0	162,0	145,0	45,0	66791
0.4449	11,300 mm		12,0	210,0	162,0	145,0	45,0	66792
0.4488	11,400 mm		12,0	210,0	162,0	145,0	45,0	66793
0.4528	11,500 mm		12,0	210,0	162,0	145,0	45,0	66794
0.4567	11,600 mm		12,0	210,0	162,0	145,0	45,0	66795
0.4606	11,700 mm		12,0	210,0	162,0	144,0	45,0	66796
0.4646	11,800 mm		12,0	210,0	162,0	144,0	45,0	66797
0.4685	11,900 mm		12,0	210,0	162,0	144,0	45,0	66798
0.4688	11,908 mm	15/32	12,0	210,0	162,0	144,0	45,0	56534
0.4724	12,000 mm		12,0	210,0	162,0	144,0	45,0	66799
0.4844	12,304 mm	31/64	14,0	234,0	189,0	171,0	45,0	56535
0.4921	12,500 mm		14,0	234,0	189,0	170,0	45,0	66800

TOLERANCES (inch)

≤.1181 DIAMETER

DC = +.0008/+0.0047
DCON = h₆

>.1181-.2362 DIAMETER

DC = +.00016/+0.00063
DCON = h₆

>.2362-.3937 DIAMETER

DC = +.00024/+0.00083
DCON = h₆

>.3937-.7087 DIAMETER

DC = +.00028/+0.00098
DCON = h₆

>.7087-1.1811 DIAMETER

DC = +.00031/+0.00114
DCON = h₆

TOLERANCES (mm)

≤3 DIAMETER

DC = +0,002/+0,012
DCON = h₆

>3-6 DIAMETER

DC = +0,004/+0,016
DCON = h₆

>6-10 DIAMETER

DC = +0,006/+0,021
DCON = h₆

>10-18 DIAMETER

DC = +0,007/+0,025
DCON = h₆

>18-30 DIAMETER

DC = +0,008/+0,029
DCON = h₆

- STEELS
- STAINLESS STEELS
- CAST IRON
- NON-FERROUS
- HIGH TEMP ALLOYS
- HARDENED STEELS

For patent information visit www.ksptpatents.com

continued on next page



FRACTIONAL & METRIC Series 142P

142P 12xD FRACTIONAL & METRIC SERIES

DECIMAL DC	METRIC DC	inch & mm						EDP NO.
		FRACTIONAL/ LETTER/WIRE DC	SHANK DIAMETER DCON	OVERALL LENGTH OAL	FLUTE LENGTH LCF	USABLE LENGTH LU	SHANK LENGTH LS	Ti-NAMITE®-X (TX)
0.5000	12,700 mm	1/2	14,0	234,0	189,0	170,0	45,0	56536
0.5039	12,800 mm		14,0	234,0	189,0	170,0	45,0	66801
0.5118	13,000 mm		14,0	234,0	189,0	170,0	45,0	66802
0.5156	13,096 mm	33/64	14,0	234,0	189,0	169,0	45,0	56537
0.5315	13,500 mm		14,0	234,0	189,0	169,0	45,0	66803
0.5433	13,800 mm		14,0	234,0	189,0	168,0	45,0	66804
0.5512	14,000 mm		14,0	234,0	189,0	168,0	45,0	66805
0.5625	14,288 mm	9/16	16,0	267,0	216,0	195,0	48,0	56538
0.5709	14,500 mm		16,0	267,0	216,0	194,0	48,0	66806
0.5781	14,684 mm	37/64	16,0	267,0	216,0	194,0	48,0	56539
0.5827	14,800 mm		16,0	267,0	216,0	194,0	48,0	66807
0.5906	15,000 mm		16,0	267,0	216,0	193,0	48,0	66808
0.6102	15,500 mm		16,0	267,0	216,0	193,0	48,0	66809
0.6221	15,800 mm		16,0	267,0	216,0	192,0	48,0	66810
0.6250	15,875 mm	5/8	16,0	267,0	216,0	192,0	48,0	56540
0.6299	16,000 mm		16,0	267,0	216,0	192,0	48,0	66811
0.6562	16,667 mm	21/32	18,0	292,0	241,0	216,0	48,0	56541
0.6875	17,463 mm	11/16	18,0	292,0	241,0	215,0	48,0	56542
0.7500	19,050 mm	3/4	20,0	319,0	266,0	238,0	50,0	56543

CONTINUED

Series 142P 12xD | Fractional & Metric

FRACTIONAL
Series 142P



Series 142P Speed & Feed Recommendations

Series 142P Fractional	Hardness	Vc (sfm)	DC • in								
			1/8	3/16	1/4	3/8	1/2	5/8	3/4		
CARBON STEELS 1018, 1040, 1080, 1090, 10L50, 1140, 1212, 12L15, 1525, 1536	≤ 175 Bhn or ≤ 7 HRc	425 (340-510)	RPM	12988	8659	6494	4329	3247	2598	2165	
			Fr	0.0043	0.0065	0.0086	0.0129	0.0172	0.0216	0.0259	
			Feed (ipm)	56.0	56.0	56.0	56.0	56.0	56.0	56.0	
	≤ 275 Bhn or ≤ 28 HRc	380 (304-456)	RPM	11613	7742	5806	3871	2903	2323	1935	
			Fr	0.0039	0.0058	0.0078	0.0116	0.0155	0.0194	0.0233	
			Feed (ipm)	45.0	45.0	45.0	45.0	45.0	45.0	45.0	
	≤ 425 Bhn or ≤ 45 HRc	220 (176-264)	RPM	6723	4482	3362	2241	1681	1345	1121	
			Fr	0.0033	0.0049	0.0065	0.0098	0.0131	0.0164	0.0196	
			Feed (ipm)	22.0	22.0	22.0	22.0	22.0	22.0	22.0	
	ALLOY STEELS 4140, 4150, 4320, 5120, 5150, 8630, 86L20, 50100	≤ 275 Bhn or ≤ 28 HRc	330 (264-396)	RPM	10085	6723	5042	3362	2521	2017	1681
				Fr	0.0033	0.0049	0.0065	0.0098	0.0131	0.0164	0.0196
				Feed (ipm)	33.0	33.0	33.0	33.0	33.0	33.0	33.0
≤ 375 Bhn or ≤ 40 HRc		200 (160-240)	RPM	6112	4075	3056	2037	1528	1222	1019	
			Fr	0.0028	0.0042	0.0056	0.0083	0.0111	0.0139	0.0167	
			Feed (ipm)	17.0	17.0	17.0	17.0	17.0	17.0	17.0	
≤ 425 Bhn or ≤ 45 HRc		140 (112-168)	RPM	4278	2852	2139	1426	1070	856	713	
			Fr	0.0020	0.0030	0.0040	0.0060	0.0079	0.0099	0.0119	
			Feed (ipm)	8.5	8.5	8.5	8.5	8.5	8.5	8.5	
TOOL STEELS A2, D2, H13, L2, M2, P20, S7, T15, W2		≤ 200 Bhn or ≤ 13 HRc	145 (116-174)	RPM	4431	2954	2216	1477	1108	886	739
				Fr	0.0028	0.0042	0.0056	0.0085	0.0113	0.0141	0.0169
				Feed (ipm)	12.5	12.5	12.5	12.5	12.5	12.5	12.5
	≤ 375 Bhn or ≤ 40 HRc	95 (76-114)	RPM	2903	1935	1452	968	726	581	484	
			Fr	0.0013	0.0020	0.0027	0.0040	0.0054	0.0067	0.0081	
			Feed (ipm)	3.9	3.9	3.9	3.9	3.9	3.9	3.9	
STAINLESS STEELS (FREE MACHINING) 303, 416, 420F, 430F, 440F	≤ 185 Bhn or ≤ 9 HRc	305 (244-366)	RPM	9321	6214	4660	3107	2330	1864	1553	
			Fr	0.0026	0.0039	0.0051	0.0077	0.0103	0.0129	0.0154	
			Feed (ipm)	24.0	24.0	24.0	24.0	24.0	24.0	24.0	
	≤ 275 Bhn or ≤ 28 HRc	195 (156-234)	RPM	5959	3973	2980	1986	1490	1192	993	
			Fr	0.0020	0.0030	0.0040	0.0060	0.0081	0.0101	0.0121	
			Feed (ipm)	12.0	12.0	12.0	12.0	12.0	12.0	12.0	
	STAINLESS STEELS (DIFFICULT) 304, 316, 321, 13-8 PH, 15-5PH, 17-4 PH, Custom 450	≤ 275 Bhn or ≤ 28 HRc	150 (120-180)	RPM	4584	3056	2292	1528	1146	917	764
				Fr	0.0020	0.0030	0.0040	0.0060	0.0079	0.0099	0.0119
				Feed (ipm)	9.1	9.1	9.1	9.1	9.1	9.1	9.1
		≤ 375 Bhn or ≤ 40 HRc	110 (88-132)	RPM	3362	2241	1681	1121	840	672	560
				Fr	0.0018	0.0027	0.0036	0.0054	0.0071	0.0089	0.0107
				Feed (ipm)	6.0	6.0	6.0	6.0	6.0	6.0	6.0
CAST IRONS Gray, Malleable, Ductile	≤ 220 Bhn or ≤ 19 HRc	360 (288-432)	RPM	11002	7334	5501	3667	2750	2200	1834	
			Fr	0.0045	0.0068	0.0091	0.0136	0.0182	0.0227	0.0273	
			Feed (ipm)	50.0	50.0	50.0	50.0	50.0	50.0	50.0	
	≤ 260 Bhn or ≤ 26 HRc	335 (268-402)	RPM	10238	6825	5119	3413	2559	2048	1706	
			Fr	0.0045	0.0068	0.0091	0.0136	0.0182	0.0227	0.0273	
			Feed (ipm)	46.5	46.5	46.5	46.5	46.5	46.5	46.5	

continued on next page

Series 142P Fractional	Hardness	Vc (sfm)		DC • in							
				1/8	3/16	1/4	3/8	1/2	5/8	3/4	
N ALUMINUM ALLOYS 2017, 2024, 356, 6061, 7075	≤ 80 Bhn or ≤ 47 HRb	770 (616-924)	RPM	23531	15687	11766	7844	5883	4706	3922	
			Fr	0.0049	0.0073	0.0098	0.0147	0.0195	0.0244	0.0293	
			Feed (ipm)	115.0	115.0	115.0	115.0	115.0	115.0	115.0	
	≤ 150 Bhn or ≤ 8 HRb	660 (528-792)	RPM	20170	13446	10085	6723	5042	4034	3362	
			Fr	0.0050	0.0074	0.0099	0.0149	0.0198	0.0248	0.0297	
			Feed (ipm)	100.0	100.0	100.0	100.0	100.0	100.0	100.0	
	COPPER ALLOYS Alum Bronze, C110, Muntz Brass	≤ 140 Bhn or ≤ 3 HRc	550 (440-660)	RPM	16808	11205	8404	5603	4202	3362	2801
				Fr	0.0020	0.0030	0.0040	0.0060	0.0080	0.0100	0.0120
				Feed (ipm)	33.5	33.5	33.5	33.5	33.5	33.5	33.5
		≤ 200 Bhn or ≤ 23 HRc	440 (352-528)	RPM	13446	8964	6723	4482	3362	2689	2241
				Fr	0.0020	0.0030	0.0040	0.0060	0.0080	0.0100	0.0120
				Feed (ipm)	27.0	27.0	27.0	27.0	27.0	27.0	27.0
S HIGH TEMP ALLOYS (NICKEL, COBALT, IRON BASE) Inconel 601, 617, 625, Incoloy, Monel 400, Rene, Waspaloy	≤ 300 Bhn or ≤ 32 HRc	95 (76-114)	RPM	2903	1935	1452	968	726	581	484	
			Fr	0.0008	0.0012	0.0016	0.0024	0.0032	0.0040	0.0048	
			Feed (ipm)	2.3	2.3	2.3	2.3	2.3	2.3	2.3	
	≤ 400 Bhn or ≤ 43 HRc	50 (40-60)	RPM	1528	1019	764	509	382	306	255	
			Fr	0.0007	0.0010	0.0013	0.0020	0.0026	0.0033	0.0039	
			Feed (ipm)	1.0	1.0	1.0	1.0	1.0	1.0	1.0	
	TITANIUM ALLOYS Pure Titanium, Ti6Al4V, Ti6Al2Sn4Zr2Mo, Ti4Al4Mo2Sn0.5Si, Ti-6Al4V	≤ 275 Bhn or ≤ 28 HRc	215 (172-258)	RPM	6570	4380	3285	2190	1643	1314	1095
				Fr	0.0018	0.0026	0.0035	0.0053	0.0070	0.0088	0.0105
				Feed (ipm)	11.5	11.5	11.5	11.5	11.5	11.5	11.5
		≤ 350 Bhn or ≤ 38 HRc	160 (128-192)	RPM	4890	3260	2445	1630	1222	978	815
				Fr	0.0016	0.0024	0.0032	0.0048	0.0064	0.0080	0.0096
				Feed (ipm)	7.8	7.8	7.8	7.8	7.8	7.8	7.8
≤ 440 Bhn or ≤ 47 HRc	85 (68-102)	RPM	2598	1732	1299	866	649	520	433		
		Fr	0.0012	0.0018	0.0024	0.0036	0.0048	0.0060	0.0072		
		Feed (ipm)	3.1	3.1	3.1	3.1	3.1	3.1	3.1		
H TOOL STEELS A2, D2, H13, L2, M2, P20, S7, T15, W2	≤ 475 Bhn or ≤ 50 HRc	85 (68-102)	RPM	2598	1732	1299	866	649	520	433	
			Fr	0.0008	0.0013	0.0017	0.0025	0.0034	0.0042	0.0051	
			Feed (ipm)	2.2	2.2	2.2	2.2	2.2	2.2	2.2	

Bhn (Brinell) HRc (Rockwell C) HRb (Rockwell B)
rpm = Vc x 3.82 / DC
ipm = Fr x RPM
reduce speed and feed for materials harder than listed
refer to the SGS Tool Wizard® for complete technical information (www.kyocera-sgstool.com)



Series 142P Metric	Hardness	Vc (m/min)	DC • mm								
			3	6	8	10	12	14	16		
CARBON STEELS 1018, 1040, 1080, 1090, 10L50, 1140, 1212, 12L15, 1525, 1536	≤ 175 Bhn or ≤ 7 HRc	130	RPM	13733	6867	5150	4120	3433	2943	2575	
		(104-155)	Fr	0.104	0.207	0.276	0.345	0.414	0.483	0.552	
			Feed (mm/min)	1422	1422	1422	1422	1422	1422	1422	
	≤ 275 Bhn or ≤ 28 HRc	116	RPM	12279	6140	4605	3684	3070	2631	2302	
		(93-139)	Fr	0.093	0.186	0.248	0.310	0.372	0.434	0.496	
			Feed (mm/min)	1143	1143	1143	1143	1143	1143	1143	
	≤ 425 Bhn or ≤ 45 HRc	67	RPM	7109	3555	2666	2133	1777	1523	1333	
		(54-80)	Fr	0.079	0.157	0.210	0.262	0.314	0.367	0.419	
			Feed (mm/min)	559	559	559	559	559	559	559	
	ALLOY STEELS 4140, 4150, 4320, 5120, 5150, 8630, 86L20, 50100	≤ 275 Bhn or ≤ 28 HRc	101	RPM	10664	5332	3999	3199	2666	2285	1999
			(80-121)	Fr	0.079	0.157	0.210	0.262	0.314	0.367	0.419
				Feed (mm/min)	838	838	838	838	838	838	838
≤ 375 Bhn or ≤ 40 HRc		61	RPM	6463	3231	2424	1939	1616	1385	1212	
		(49-73)	Fr	0.067	0.134	0.178	0.223	0.267	0.312	0.356	
			Feed (mm/min)	432	432	432	432	432	432	432	
≤ 425 Bhn or ≤ 45 HRc		43	RPM	4524	2262	1696	1357	1131	969	848	
		(34-51)	Fr	0.048	0.095	0.127	0.159	0.191	0.223	0.255	
			Feed (mm/min)	216	216	216	216	216	216	216	
TOOL STEELS A2, D2, H13, L2, M2, P20, S7, T15, W2		≤ 200 Bhn or ≤ 13 HRc	44	RPM	4686	2343	1757	1406	1171	1004	879
			(35-53)	Fr	0.068	0.136	0.181	0.226	0.271	0.316	0.361
				Feed (mm/min)	318	318	318	318	318	318	318
	≤ 375 Bhn or ≤ 40 HRc	29	RPM	3070	1535	1151	921	767	658	576	
		(23-35)	Fr	0.032	0.065	0.086	0.108	0.129	0.151	0.172	
			Feed (mm/min)	99	99	99	99	99	99	99	
STAINLESS STEELS (FREE MACHINING) 303, 416, 420F, 430F, 440F	≤ 185 Bhn or ≤ 9 HRc	93	9856	9856	4928	3696	2957	2464	2112	1848	
		(74-112)	0.062	0.062	0.124	0.165	0.206	0.247	0.289	0.330	
			610	610	610	610	610	610	610	610	
	≤ 275 Bhn or ≤ 28 HRc	59	6301	6301	3151	2363	1890	1575	1350	1181	
		(48-71)	0.048	0.048	0.097	0.129	0.161	0.193	0.226	0.258	
			305	305	305	305	305	305	305	305	
	STAINLESS STEELS (DIFFICULT) 304, 316, 321, 13-8 PH, 15-5PH, 17-4 PH, Custom 450	≤ 275 Bhn or ≤ 28 HRc	46	4847	4847	2424	1818	1454	1212	1039	909
			(37-55)	0.048	0.048	0.095	0.127	0.159	0.191	0.223	0.254
				231	231	231	231	231	231	231	231
		≤ 375 Bhn or ≤ 40 HRc	34	3555	3555	1777	1333	1066	889	762	666
			(27-40)	0.043	0.043	0.086	0.114	0.143	0.171	0.200	0.229
				152	152	152	152	152	152	152	152
CAST IRONS Gray, Malleable, Ductile	≤ 220 Bhn or ≤ 19 HRc	110	RPM	11633	5816	4362	3490	2908	2493	2181	
		(88-132)	Fr	0.109	0.218	0.291	0.364	0.437	0.509	0.582	
			Feed (mm/min)	1270	1270	1270	1270	1270	1270	1270	
	≤ 260 Bhn or ≤ 26 HRc	102	RPM	10825	5413	4059	3248	2706	2320	2030	
		(82-123)	Fr	0.109	0.218	0.291	0.364	0.436	0.509	0.582	
			Feed (mm/min)	1181	1181	1181	1181	1181	1181	1181	

continued on next page

Series 142P Metric	Hardness	Vc (m/min)	DC • mm								
			3	6	8	10	12	14	16		
N ALUMINUM ALLOYS 2017, 2024, 356, 6061, 7075	≤ 80 Bhn or ≤ 47 HRb	235	RPM	24882	12441	9331	7465	6220	5332	4665	
		(188-282)	Fr	0.117	0.235	0.313	0.391	0.470	0.548	0.626	
			Feed (mm/min)	2921	2921	2921	2921	2921	2921	2921	
	≤ 150 Bhn or ≤ 88 HRb	201	RPM	21327	10664	7998	6398	5332	4570	3999	
		(161-241)	Fr	0.119	0.238	0.318	0.397	0.476	0.556	0.635	
			Feed (mm/min)	2540	2540	2540	2540	2540	2540	2540	
	Copper Alloys Alum Bronze, C110, Muntz Brass	≤ 140 Bhn or ≤ 3 HRc	168	RPM	17773	8886	6665	5332	4443	3808	3332
			(134-201)	Fr	0.048	0.096	0.128	0.160	0.192	0.223	0.255
				Feed (mm/min)	851	851	851	851	851	851	851
		≤ 200 Bhn or ≤ 23 HRc	134	RPM	14218	7109	5332	4265	3555	3047	2666
			(107-161)	Fr	0.048	0.096	0.129	0.161	0.193	0.225	0.257
				Feed (mm/min)	686	686	686	686	686	686	686
S HIGH TEMP ALLOYS (Nickel, Cobalt, Iron Base) Inconel 601, 617, 625, Incoloy, Monel 400, Rene, Waspaloy	≤ 300 Bhn or ≤ 32 HRc	29	RPM	3070	1535	1151	921	767	658	576	
		(23-35)	Fr	0.019	0.038	0.051	0.063	0.076	0.089	0.101	
			Feed (mm/min)	58	58	58	58	58	58	58	
	≤ 400 Bhn or ≤ 43 HRc	15	RPM	1616	808	606	485	404	346	303	
		(12-18)	Fr	0.016	0.031	0.042	0.052	0.063	0.073	0.084	
			Feed (mm/min)	25	25	25	25	25	25	25	
	TITANIUM ALLOYS Pure Titanium, Ti6Al4V, Ti6Al2Sn4Zr2Mo, Ti4Al4Mo2Sn0.5Si, Ti-6Al4V	≤ 275 Bhn or ≤ 28 HRc	66	RPM	6947	3474	2605	2084	1737	1489	1303
			(52-79)	Fr	0.042	0.084	0.112	0.140	0.168	0.196	0.224
				Feed (mm/min)	292	292	292	292	292	292	292
		≤ 350 Bhn or ≤ 38 HRc	49	RPM	5170	2585	1939	1551	1293	1108	969
			(39-59)	Fr	0.038	0.077	0.102	0.128	0.153	0.179	0.204
				Feed (mm/min)	198	198	198	198	198	198	198
≤ 440 Bhn or ≤ 47 HRc	26	RPM	2747	1373	1030	824	687	589	515		
	(21-31)	Fr	0.029	0.057	0.076	0.096	0.115	0.134	0.153		
		Feed (mm/min)	79	79	79	79	79	79	79		
H TOOL STEELS A2, D2, H13, L2, M2, P20, S7, T15, W2	≤ 475 Bhn or ≤ 50 HRc	26	RPM	2747	1373	1030	824	687	589	515	
		(21-31)	Fr	0.020	0.041	0.054	0.068	0.081	0.095	0.109	
			Feed (mm/min)	56	56	56	56	56	56	56	

(Brinell) HRc (Rockwell C) HRb (Rockwell B)
 rpm = (Vc x 1000) / (DC x 3.14)
 mm/min = Fr x RPM
 reduce speed and feed for materials harder than listed
 refer to the SGS Tool Wizard® for complete technical information (www.kyocera-sgstool.com)

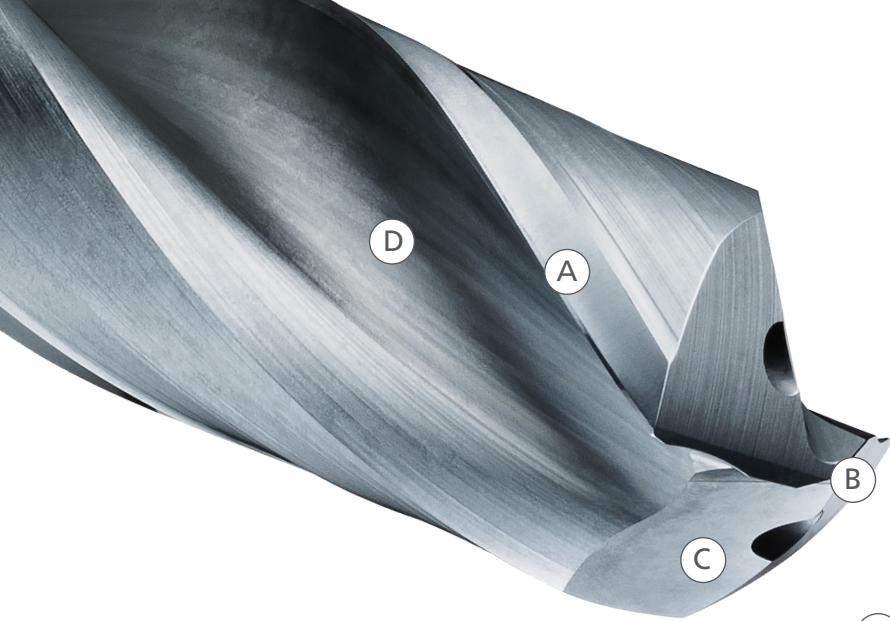

SERIES 143M-S

- (A) ECCENTRIC 2-MARGIN DESIGN**
- eccentric margin design reduces frictional heat and minimizes material adhesion to the margins without weakening the drill
 - lower contact with the hole surface improves hole finish and quality, especially in gummy workpiece materials
- (B) POINT**
- point design stabilizes on contact for exceptional hole size and cylindricity
 - low thrust force reduces machine power requirement and extends tool life
 - computer controlled edge hone protects against chip damage
- (C) COOLANT THROUGH DESIGN**
- the modified coolant hole exit increases flow for improved chip evacuation and extended tool life
- (D) COATING AND CARBIDE**
- SGS Ti-NAMITE®-A coating provides exceptional wear and erosion resistance when drilling heat resisting alloys like Inconel, stainless steel, and titanium
 - Series 143M-S drills are manufactured from lab certified premium quality carbide



HIGH PERFORMANCE CARBIDE DRILLS

The key features designed into the Hi-PerCarb® Series 143M-S Drill allow the product to offer application benefits not only beyond that of standard carbide drills, but also other High Performance drills. Each feature of the Hi-PerCarb® Series 143M-S Drill was uniquely engineered as a solution towards addressing the issues commonly encountered during high production drilling.

PERFORMANCE. PRECISION. PASSION.
HI-PERCARB® SERIES 143M-S DRILLS

PERFORMANCE.

TESTING PARAMETERS

- 3/8" Cutting Diameter
- 316 Stainless Steel (160 Bhn)
- 1630 rpm
- 9.8 ipm
- 1.875" Axial Depth
- TSC – Water Sol 8.9%

TITANIUM TESTING PARAMETERS

- 3/8" Cutting Diameter
- Ti6Al4v Titanium (38 HRC)
- 1630 rpm
- 7.8 ipm
- 1.875" Axial Depth
- TSC – Water Sol 8.9%

INCONEL TESTING PARAMETERS

- 3/8" Cutting Diameter
- 718 Inconel (43Hrc)
- 710 rpm
- 2.55 ipm
- 1.125" Axial Depth
- TSC – Water Sol 8.9

FINISH COMPARISON TEST RESULTS

The lower numerical value shown in the chart demonstrates the improved surface finish of holes produced by a drill with an eccentric margin like the HI-PERCARB® 143M-S in all materials tested versus holes made by drills with a normal margin.

FINISH COMPARISON (ALL MATERIALS)

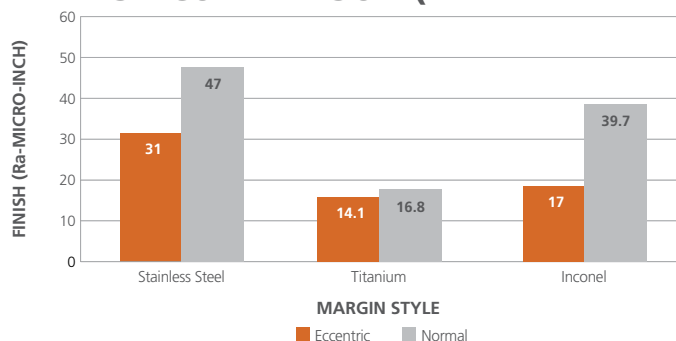

TOOL LIFE COMPARISON

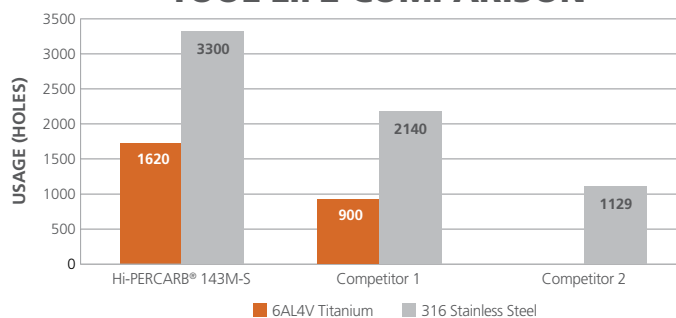

TOOL LIFE COMPARISON TEST RESULTS

All tools were tested to failure, and under these conditions, the HI-PERCARB® 143M-S produced the most holes versus the competition in both materials tested.



Excellent thermal and chemical resistance allows for dry cutting and improvements in performance of carbide. The coating has a high hardness giving great protection against abrasive wear and erosion.

Hardness (HV): 3700

Oxidation Temperature: 1100°C – 2010°F

Coefficient of Friction: 0.30

Thickness: 1 – 5 Microns (based on tool diameter)

FRACTIONAL & METRIC Series 143M-S

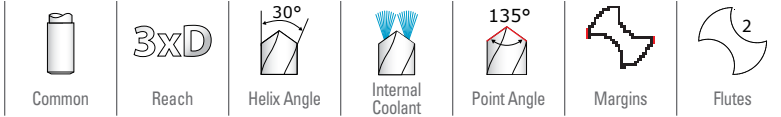

143M-S 3xD

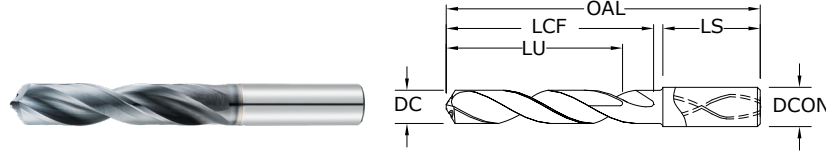

Series 143M-S 3xD Fractional & Metric

- Coolant through design improves coolant flow to extend tool life and aid in chip evacuation
- Eccentric 2-margin design reduces frictional heat and minimizes material adhesion to the margins without weakening the drill
- Computer controlled edge honing protects against chip damage
- High-performance point design stabilizes on contact for exceptional hole size and cylindricity allowing for low thrust force and extended tool life
- SGS Ti-NAMITE®-A coating provides exceptional wear and erosion resistance when drilling heat resisting alloys like Inconel, Stainless Steel, and Titanium Alloys
- Recommended for materials ≤ 50HRc (475 Bhn)

inch & mm									EDP NO.
DECIMAL DC	METRIC DC	FRACTIONAL/ LETTER/WIRE DC	SHANK DIAMETER DCON	OVERALL LENGTH OAL	FLUTE LENGTH LCF	USABLE LENGTH LU	SHANK LENGTH LS	Ti-NAMITE®-A (AITiN)	
0.1181	3,000 mm		6,0	62,0	20,0	15,0	36,0	69120	
0.1220	3,100 mm		6,0	62,0	20,0	15,0	36,0	69121	
0.1250	3,175 mm	1/8	6,0	62,0	20,0	15,0	36,0	56800	
0.1260	3,200 mm		6,0	62,0	20,0	15,0	36,0	69122	
0.1299	3,300 mm		6,0	62,0	20,0	15,0	36,0	69123	
0.1339	3,400 mm		6,0	62,0	20,0	15,0	36,0	69124	
0.1360	3,454 mm	#29	6,0	62,0	20,0	15,0	36,0	56801	
0.1378	3,500 mm		6,0	62,0	20,0	15,0	36,0	69125	
0.1406	3,571 mm	9/64	6,0	62,0	20,0	15,0	36,0	56802	
0.1417	3,600 mm		6,0	62,0	20,0	15,0	36,0	69126	
0.1457	3,700 mm		6,0	62,0	20,0	15,0	36,0	69127	
0.1496	3,800 mm		6,0	66,0	24,0	18,0	36,0	69128	
0.1535	3,900 mm		6,0	66,0	24,0	18,0	36,0	69129	
0.1562	3,967 mm	5/32	6,0	66,0	24,0	18,0	36,0	56803	
0.1575	4,000 mm		6,0	66,0	24,0	18,0	36,0	69130	
0.1590	4,039 mm	#21	6,0	66,0	24,0	18,0	36,0	56804	
0.1614	4,100 mm		6,0	66,0	24,0	18,0	36,0	69131	
0.1654	4,200 mm		6,0	66,0	24,0	18,0	36,0	69132	
0.1693	4,300 mm		6,0	66,0	24,0	18,0	36,0	69133	
0.1719	4,366 mm	11/64	6,0	66,0	24,0	17,0	36,0	56805	
0.1732	4,400 mm		6,0	66,0	24,0	17,0	36,0	69134	
0.1772	4,500 mm		6,0	66,0	24,0	17,0	36,0	69135	
0.1811	4,600 mm		6,0	66,0	24,0	17,0	36,0	69136	
0.1850	4,699 mm	#13	6,0	66,0	24,0	17,0	36,0	69137	
0.1875	4,763 mm	3/16	6,0	66,0	28,0	21,0	36,0	56806	
0.1890	4,801 mm	#12	6,0	66,0	28,0	21,0	36,0	69138	
0.1929	4,900 mm		6,0	66,0	28,0	21,0	36,0	69139	
0.1969	5,000 mm		6,0	66,0	28,0	20,0	36,0	69140	
0.2008	5,100 mm		6,0	66,0	28,0	20,0	36,0	69141	
0.2031	5,159 mm	13/64	6,0	66,0	28,0	20,0	36,0	56807	
0.2047	5,200 mm		6,0	66,0	28,0	20,0	36,0	69142	
0.2087	5,300 mm		6,0	66,0	28,0	20,0	36,0	69143	
0.2126	5,400 mm		6,0	66,0	28,0	20,0	36,0	69144	
0.2165	5,500 mm		6,0	66,0	28,0	20,0	36,0	69145	
0.2188	5,558 mm	7/32	6,0	66,0	28,0	20,0	36,0	56808	
0.2205	5,600 mm		6,0	66,0	28,0	20,0	36,0	69146	
0.2244	5,700 mm		6,0	66,0	28,0	19,0	36,0	69147	
0.2283	5,800 mm		6,0	66,0	28,0	19,0	36,0	69148	
0.2323	5,900 mm		6,0	66,0	28,0	19,0	36,0	69149	
0.2344	5,954 mm	15/64	6,0	66,0	28,0	19,0	36,0	56809	
0.2362	6,000 mm		6,0	66,0	28,0	19,0	36,0	69150	
0.2402	6,100 mm		8,0	79,0	34,0	25,0	36,0	69151	
0.2441	6,200 mm		8,0	79,0	34,0	25,0	36,0	69152	
0.2480	6,300 mm		8,0	79,0	34,0	25,0	36,0	69153	

TOLERANCES (inch)

- ≤.1181 DIAMETER
DC = +.00008/+0.00047
DCON = h₆
- >.1181–.2362 DIAMETER
DC = +.00016/+0.00063
DCON = h₆
- >.2362–.3937 DIAMETER
DC = +.00024/+0.00083
DCON = h₆
- >.3937–.7087 DIAMETER
DC = +.00028/+0.00098
DCON = h₆
- >.7087–1.1811 DIAMETER
DC = +.00031/+0.00114
DCON = h₆

TOLERANCES (mm)

- ≤3 DIAMETER
DC = +0,002/+0,012
DCON = h₆
- >3–6 DIAMETER
DC = +0,004/+0,016
DCON = h₆
- >6–10 DIAMETER
DC = +0,006/+0,021
DCON = h₆
- >10–18 DIAMETER
DC = +0,007/+0,025
DCON = h₆
- >18–30 DIAMETER
DC = +0,008/+0,029
DCON = h₆

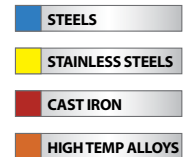

For patent information visit www.ksptpatents.com

continued on next page



FRACTIONAL & METRIC
Series 143M-S

143M-S 3xD
 FRACTIONAL & METRIC SERIES

CONTINUED

DECIMAL DC	METRIC DC	inch & mm						EDP NO. Ti-NAMITE [®] -A (AITIN)
		FRACTIONAL/ LETTER/WIRE DC	SHANK DIAMETER DCON	OVERALL LENGTH OAL	FLUTE LENGTH LCF	USABLE LENGTH LU	SHANK LENGTH LS	
0.2500	6,350 mm	1/4 E #0	8,0	79,0	34,0	24,0	36,0	56810
0.2520	6,400 mm		8,0	79,0	34,0	24,0	36,0	69154
0.2559	6,500 mm		8,0	79,0	34,0	24,0	36,0	69155
0.2570	6,528 mm	F	8,0	79,0	34,0	24,0	36,0	56811
0.2598	6,600 mm		8,0	79,0	34,0	24,0	36,0	69156
0.2638	6,700 mm		8,0	79,0	34,0	24,0	36,0	69157
0.2656	6,746 mm	17/64	8,0	79,0	34,0	24,0	36,0	56812
0.2677	6,800 mm		8,0	79,0	34,0	24,0	36,0	69158
0.2717	6,900 mm		8,0	79,0	34,0	24,0	36,0	69159
0.2756	7,000 mm		8,0	79,0	34,0	24,0	36,0	69160
0.2795	7,100 mm		8,0	79,0	41,0	30,0	36,0	69161
0.2812	7,142 mm	9/32	8,0	79,0	41,0	30,0	36,0	56813
0.2835	7,200 mm		8,0	79,0	41,0	30,0	36,0	69162
0.2874	7,300 mm		8,0	79,0	41,0	30,0	36,0	69163
0.2913	7,400 mm		8,0	79,0	41,0	30,0	36,0	69164
0.2953	7,500 mm		8,0	79,0	41,0	30,0	36,0	69165
0.2969	7,541 mm	19/64	8,0	79,0	41,0	30,0	36,0	56814
0.2992	7,600 mm		8,0	79,0	41,0	30,0	36,0	69166
0.3031	7,700 mm		8,0	79,0	41,0	29,0	36,0	69167
0.3071	7,800 mm		8,0	79,0	41,0	29,0	36,0	69168
0.3110	7,900 mm		8,0	79,0	41,0	29,0	36,0	69169
0.3125	7,938 mm	5/16	8,0	79,0	41,0	29,0	36,0	56815
0.3150	8,000 mm		8,0	79,0	41,0	29,0	36,0	69170
0.3189	8,100 mm		10,0	89,0	47,0	35,0	40,0	69171
0.3228	8,200 mm		10,0	89,0	47,0	35,0	40,0	69172
0.3268	8,300 mm		10,0	89,0	47,0	35,0	40,0	69173
0.3281	8,334 mm	21/64	10,0	89,0	47,0	34,0	40,0	56816
0.3307	8,400 mm		10,0	89,0	47,0	34,0	40,0	69174
0.3320	8,433 mm	Q	10,0	89,0	47,0	34,0	40,0	56817
0.3346	8,500 mm		10,0	89,0	47,0	34,0	40,0	69175
0.3386	8,600 mm		10,0	89,0	47,0	34,0	40,0	69176
0.3425	8,700 mm		10,0	89,0	47,0	34,0	40,0	69177
0.3438	8,733 mm	11/32	10,0	89,0	47,0	34,0	40,0	56818
0.3465	8,800 mm		10,0	89,0	47,0	34,0	40,0	69178
0.3504	8,900 mm		10,0	89,0	47,0	34,0	40,0	69179
0.3543	9,000 mm		10,0	89,0	47,0	34,0	40,0	69180
0.3583	9,100 mm		10,0	89,0	47,0	33,0	40,0	69181
0.3594	9,129 mm	23/64	10,0	89,0	47,0	33,0	40,0	56819
0.3622	9,200 mm		10,0	89,0	47,0	33,0	40,0	69182
0.3661	9,300 mm		10,0	89,0	47,0	33,0	40,0	69183
0.3680	9,347 mm	U	10,0	89,0	47,0	33,0	40,0	56820
0.3701	9,400 mm		10,0	89,0	47,0	33,0	40,0	69184
0.3740	9,500 mm		10,0	89,0	47,0	33,0	40,0	69185
0.3750	9,525 mm	3/8	10,0	89,0	47,0	33,0	40,0	56821
0.3780	9,600 mm		10,0	89,0	47,0	33,0	40,0	69186
0.3819	9,700 mm		10,0	89,0	47,0	32,0	40,0	69187
0.3858	9,800 mm		10,0	89,0	47,0	32,0	40,0	69188
0.3898	9,900 mm		10,0	89,0	47,0	32,0	40,0	69189
0.3906	9,921 mm	25/64	10,0	89,0	47,0	32,0	40,0	56822
0.3937	10,000 mm		10,0	89,0	47,0	32,0	40,0	69190
0.3976	10,100 mm		12,0	102,0	55,0	40,0	45,0	69191
0.4016	10,200 mm		12,0	102,0	55,0	40,0	45,0	69192

continued on next page

Series 143M-S 3xD | Fractional & Metric

FRACTIONAL & METRIC Series 143M-S



143M-S 3xD FRACTIONAL & METRIC SERIES

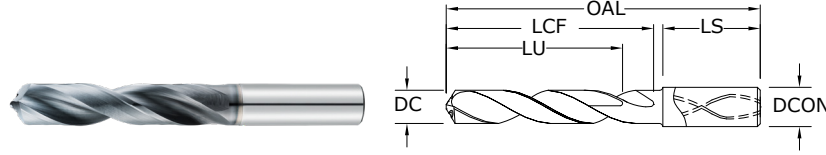

Series 143M-S 3xD Fractional & Metric

- Coolant through design improves coolant flow to extend tool life and aid in chip evacuation
- Eccentric 2-margin design reduces frictional heat and minimizes material adhesion to the margins without weakening the drill
- Computer controlled edge honing protects against chip damage
- High-performance point design stabilizes on contact for exceptional hole size and cylindricity allowing for low thrust force and extended tool life
- SGS Ti-NAMITE®-A coating provides exceptional wear and erosion resistance when drilling heat resisting alloys like Inconel, Stainless Steel, and Titanium Alloys
- Recommended for materials ≤ 50HRc (475 Bhn)

inch & mm									EDP NO.
DECIMAL DC	METRIC DC	FRACTIONAL/ LETTER/WIRE DC	SHANK DIAMETER DCON	OVERALL LENGTH OAL	FLUTE LENGTH LCF	USABLE LENGTH LU	SHANK LENGTH LS		Ti-NAMITE®-A (AITiN)
0.4055	10,300 mm		12,0	102,0	55,0	40,0	45,0		69193
0.4062	10,317 mm	13/32	12,0	102,0	55,0	40,0	45,0		56823
0.4095	10,400 mm		12,0	102,0	55,0	39,0	45,0		69194
0.4134	10,500 mm		12,0	102,0	55,0	39,0	45,0		69195
0.4173	10,600 mm		12,0	102,0	55,0	39,0	45,0		69196
0.4213	10,700 mm		12,0	102,0	55,0	39,0	45,0		69197
0.4219	10,716 mm	27/64	12,0	102,0	55,0	39,0	45,0		56824
0.4252	10,800 mm		12,0	102,0	55,0	39,0	45,0		69198
0.4291	10,900 mm		12,0	102,0	55,0	39,0	45,0		69199
0.4331	11,000 mm		12,0	102,0	55,0	39,0	45,0		69200
0.4370	11,100 mm		12,0	102,0	55,0	38,0	45,0		69201
0.4375	11,113 mm	7/16	12,0	102,0	55,0	38,0	45,0		56825
0.4409	11,200 mm		12,0	102,0	55,0	38,0	45,0		69202
0.4449	11,300 mm		12,0	102,0	55,0	38,0	45,0		69203
0.4488	11,400 mm		12,0	102,0	55,0	38,0	45,0		69204
0.4528	11,500 mm		12,0	102,0	55,0	38,0	45,0		69205
0.4567	11,600 mm		12,0	102,0	55,0	38,0	45,0		69206
0.4606	11,700 mm		12,0	102,0	55,0	37,0	45,0		69207
0.4646	11,800 mm		12,0	102,0	55,0	37,0	45,0		69208
0.4685	11,900 mm		12,0	102,0	55,0	37,0	45,0		69209
0.4688	11,908 mm	15/32	12,0	102,0	55,0	37,0	45,0		56826
0.4724	12,000 mm		12,0	102,0	55,0	37,0	45,0		69210
0.4844	12,304 mm	31/64	14,0	107,0	60,0	41,0	45,0		56827
0.4921	12,500 mm		14,0	107,0	60,0	41,0	45,0		69211
0.5000	12,700 mm	1/2	14,0	107,0	60,0	41,0	45,0		56828
0.5039	12,800 mm		14,0	107,0	60,0	41,0	45,0		69212
0.5118	13,000 mm		14,0	107,0	60,0	41,0	45,0		69213
0.5156	13,096 mm	33/64	14,0	107,0	60,0	40,0	45,0		56829
0.5315	13,500 mm		14,0	107,0	60,0	40,0	45,0		69214
0.5433	13,800 mm		14,0	107,0	60,0	39,0	45,0		69215
0.5512	14,000 mm		14,0	107,0	60,0	39,0	45,0		69216
0.5625	14,288 mm	9/16	16,0	115,0	65,0	43,0	48,0		56830
0.5709	14,500 mm		16,0	115,0	65,0	43,0	48,0		69217
0.5781	14,684 mm	37/64	16,0	115,0	65,0	43,0	48,0		56831
0.5827	14,800 mm		16,0	115,0	65,0	43,0	48,0		69218
0.5906	15,000 mm		16,0	115,0	65,0	42,0	48,0		69219
0.6102	15,500 mm		16,0	115,0	65,0	42,0	48,0		69220
0.6221	15,800 mm		16,0	115,0	65,0	41,0	48,0		69221
0.6250	15,875 mm	5/8	16,0	115,0	65,0	41,0	48,0		56832
0.6299	16,000 mm		16,0	115,0	65,0	41,0	48,0		69222
0.6562	16,667 mm	21/32	18,0	123,0	73,0	47,0	48,0		56833
0.6875	17,463 mm	11/16	18,0	123,0	73,0	47,0	48,0		56834
0.7500	19,050 mm	3/4	20,0	131,0	79,0	50,0	50,0		56835

TOLERANCES (inch)

- ≤.1181 DIAMETER
DC = +.0008/+0.0047
DCON = h₆
- >.1181-.2362 DIAMETER
DC = +.00016/+0.00063
DCON = h₆
- >.2362-.3937 DIAMETER
DC = +.00024/+0.00083
DCON = h₆
- >.3937-.7087 DIAMETER
DC = +.00028/+0.00098
DCON = h₆
- >.7087-1.1811 DIAMETER
DC = +.00031/+0.00114
DCON = h₆

TOLERANCES (mm)

- ≤3 DIAMETER
DC = +0,002/+0,012
DCON = h₆
- >3-6 DIAMETER
DC = +0,004/+0,016
DCON = h₆
- >6-10 DIAMETER
DC = +0,006/+0,021
DCON = h₆
- >10-18 DIAMETER
DC = +0,007/+0,025
DCON = h₆
- >18-30 DIAMETER
DC = +0,008/+0,029
DCON = h₆

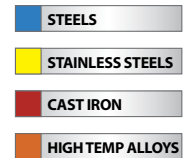

For patent information visit www.ksptpatents.com

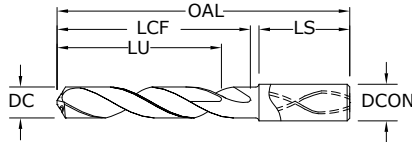
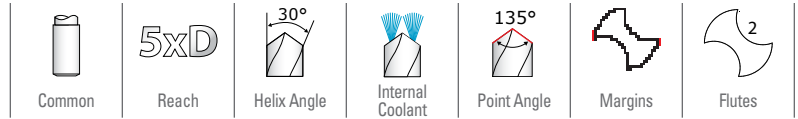

143M-S 5xD
FRACTIONAL & METRIC SERIES

TOLERANCES (inch)

≤.1181 DIAMETER

DC = +.00008/+0.00047

DCON = h₆

>.1181-.2362 DIAMETER

DC = +.00016/+0.00063

DCON = h₆

>.2362-.3937 DIAMETER

DC = +.00024/+0.00083

DCON = h₆

>.3937-.7087 DIAMETER

DC = +.00028/+0.00098

DCON = h₆

>.7087-1.1811 DIAMETER

DC = +.00031/+0.00114

DCON = h₆

TOLERANCES (mm)

≤3 DIAMETER

DC = +0,002/+0,012

DCON = h₆

>3-6 DIAMETER

DC = +0,004/+0,016

DCON = h₆

>6-10 DIAMETER

DC = +0,006/+0,021

DCON = h₆

>10-18 DIAMETER

DC = +0,007/+0,025

DCON = h₆

>18-30 DIAMETER

DC = +0,008/+0,029

DCON = h₆

STEELS

STAINLESS STEELS

CAST IRON

HIGH TEMP ALLOYS

For patent information visit www.ksptpatents.com

inch & mm									EDP NO.
DECIMAL DC	METRIC DC	FRACTIONAL/ LETTER/WIRE DC	SHANK DIAMETER DCON	OVERALL LENGTH OAL	FLUTE LENGTH LCF	USABLE LENGTH LU	SHANK LENGTH LS	Ti-NAMITE®-A (AITIN)	
0.1181	3,000 mm		6,0	66,0	28,0	23,0	36,0	69223	
0.1220	3,100 mm		6,0	66,0	28,0	23,0	36,0	69224	
0.1250	3,175 mm	1/8	6,0	66,0	28,0	23,0	36,0	56836	
0.1260	3,200 mm		6,0	66,0	28,0	23,0	36,0	69225	
0.1299	3,300 mm		6,0	66,0	28,0	23,0	36,0	69226	
0.1339	3,400 mm		6,0	66,0	28,0	23,0	36,0	69227	
0.1360	3,454 mm	#29	6,0	66,0	28,0	23,0	36,0	56837	
0.1378	3,500 mm		6,0	66,0	28,0	23,0	36,0	69228	
0.1406	3,571 mm	9/64	6,0	66,0	28,0	23,0	36,0	56838	
0.1417	3,600 mm		6,0	66,0	28,0	23,0	36,0	69229	
0.1457	3,700 mm		6,0	66,0	28,0	23,0	36,0	69230	
0.1496	3,800 mm		6,0	74,0	36,0	29,0	36,0	69231	
0.1535	3,900 mm		6,0	74,0	36,0	29,0	36,0	69232	
0.1562	3,967 mm	5/32	6,0	74,0	36,0	29,0	36,0	56839	
0.1575	4,000 mm		6,0	74,0	36,0	29,0	36,0	69233	
0.1590	4,039 mm	#21	6,0	74,0	36,0	29,0	36,0	56840	
0.1614	4,100 mm		6,0	74,0	36,0	29,0	36,0	69234	
0.1654	4,200 mm		6,0	74,0	36,0	29,0	36,0	69235	
0.1693	4,300 mm		6,0	74,0	36,0	29,0	36,0	69236	
0.1719	4,366 mm	11/64	6,0	74,0	36,0	29,0	36,0	56841	
0.1732	4,400 mm		6,0	74,0	36,0	29,0	36,0	69237	
0.1772	4,500 mm		6,0	74,0	36,0	29,0	36,0	69238	
0.1811	4,600 mm		6,0	74,0	36,0	29,0	36,0	69239	
0.1850	4,699 mm	#13	6,0	74,0	36,0	29,0	36,0	69240	
0.1875	4,763 mm	3/16	6,0	82,0	44,0	37,0	36,0	56842	
0.1890	4,801 mm	#12	6,0	82,0	44,0	37,0	36,0	69241	
0.1929	4,900 mm		6,0	82,0	44,0	37,0	36,0	69242	
0.1969	5,000 mm		6,0	82,0	44,0	36,0	36,0	69243	
0.2008	5,100 mm		6,0	82,0	44,0	36,0	36,0	69244	
0.2031	5,159 mm	13/64	6,0	82,0	44,0	36,0	36,0	56843	
0.2047	5,200 mm		6,0	82,0	44,0	36,0	36,0	69245	
0.2087	5,300 mm		6,0	82,0	44,0	36,0	36,0	69246	
0.2126	5,400 mm		6,0	82,0	44,0	36,0	36,0	69247	
0.2165	5,500 mm		6,0	82,0	44,0	36,0	36,0	69248	
0.2188	5,558 mm	7/32	6,0	82,0	44,0	36,0	36,0	56844	
0.2205	5,600 mm		6,0	82,0	44,0	36,0	36,0	69249	
0.2244	5,700 mm		6,0	82,0	44,0	35,0	36,0	69250	
0.2283	5,800 mm		6,0	82,0	44,0	35,0	36,0	69251	
0.2323	5,900 mm		6,0	82,0	44,0	35,0	36,0	69252	
0.2344	5,954 mm	15/64	6,0	82,0	44,0	35,0	36,0	56845	
0.2362	6,000 mm		6,0	82,0	44,0	35,0	36,0	69253	
0.2402	6,100 mm		8,0	91,0	53,0	44,0	36,0	69254	
0.2441	6,200 mm		8,0	91,0	53,0	44,0	36,0	69255	
0.2480	6,300 mm		8,0	91,0	53,0	44,0	36,0	69256	

- Coolant through design improves coolant flow to extend tool life and aid in chip evacuation
- Eccentric 2-margin design reduces frictional heat and minimizes material adhesion to the margins without weakening the drill
- Computer controlled edge honing protects against chip damage
- High-performance point design stabilizes on contact for exceptional hole size and cylindricity allowing for low thrust force and extended tool life
- SGS Ti-NAMITE®-A coating provides exceptional wear and erosion resistance when drilling heat resisting alloys like Inconel, Stainless Steel, and Titanium Alloys
- Recommended for materials ≤ 50HRC (475 Bhn)

Series 143M-S 5xD Fractional & Metric

continued on next page

FRACTIONAL & METRIC Series 143M-S



143M-S 5xD FRACTIONAL & METRIC SERIES

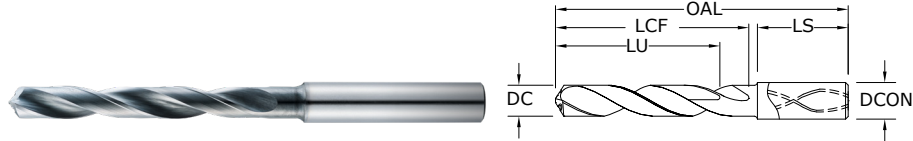

Series 143M-S 5xD Fractional & Metric

- Coolant through design improves coolant flow to extend tool life and aid in chip evacuation
- Eccentric 2-margin design reduces frictional heat and minimizes material adhesion to the margins without weakening the drill
- Computer controlled edge honing protects against chip damage
- High-performance point design stabilizes on contact for exceptional hole size and cylindricity allowing for low thrust force and extended tool life
- SGS Ti-NAMITE®-A coating provides exceptional wear and erosion resistance when drilling heat resisting alloys like Inconel, Stainless Steel, and Titanium Alloys
- Recommended for materials ≤ 50HRc (475 Bhn)

		inch & mm						EDP NO.	
DECIMAL DC	METRIC DC	FRACTIONAL/ LETTER/WIRE DC	SHANK DIAMETER DCON	OVERALL LENGTH OAL	FLUTE LENGTH LCF	USABLE LENGTH LU	SHANK LENGTH LS	Ti-NAMITE®-A (AITiN)	
0.2500	6,350 mm	1/4 E #0	8,0	91,0	53,0	43,0	36,0	56846	
0.2520	6,400 mm		8,0	91,0	53,0	43,0	36,0	69257	
0.2559	6,500 mm		8,0	91,0	53,0	43,0	36,0	69258	
0.2570	6,528 mm	F	8,0	91,0	53,0	43,0	36,0	56847	
0.2598	6,600 mm		8,0	91,0	53,0	43,0	36,0	69259	
0.2638	6,700 mm		8,0	91,0	53,0	43,0	36,0	69260	
0.2656	6,746 mm	17/64	8,0	91,0	53,0	43,0	36,0	56848	
0.2677	6,800 mm		8,0	91,0	53,0	43,0	36,0	69261	
0.2717	6,900 mm		8,0	91,0	53,0	43,0	36,0	69262	
0.2756	7,000 mm		8,0	91,0	53,0	42,0	36,0	69263	
0.2795	7,100 mm		8,0	91,0	53,0	42,0	36,0	69264	
0.2812	7,142 mm	9/32	8,0	91,0	53,0	42,0	36,0	56849	
0.2835	7,200 mm		8,0	91,0	53,0	42,0	36,0	69265	
0.2874	7,300 mm		8,0	91,0	53,0	42,0	36,0	69266	
0.2913	7,400 mm		8,0	91,0	53,0	42,0	36,0	69267	
0.2953	7,500 mm		8,0	91,0	53,0	42,0	36,0	69268	
0.2969	7,541 mm	19/64	8,0	91,0	53,0	42,0	36,0	56850	
0.2992	7,600 mm		8,0	91,0	53,0	42,0	36,0	69269	
0.3031	7,700 mm		8,0	91,0	53,0	41,0	36,0	69270	
0.3071	7,800 mm		8,0	91,0	53,0	41,0	36,0	69271	
0.3110	7,900 mm		8,0	91,0	53,0	41,0	36,0	69272	
0.3125	7,938 mm	5/16	8,0	91,0	53,0	41,0	36,0	56851	
0.3150	8,000 mm		8,0	91,0	53,0	41,0	36,0	69273	
0.3189	8,100 mm		10,0	103,0	61,0	49,0	40,0	69274	
0.3228	8,200 mm		10,0	103,0	61,0	49,0	40,0	69275	
0.3268	8,300 mm		10,0	103,0	61,0	49,0	40,0	69276	
0.3281	8,334 mm	21/64	10,0	103,0	61,0	48,0	40,0	56852	
0.3307	8,400 mm		10,0	103,0	61,0	48,0	40,0	69277	
0.3320	8,433 mm	Q	10,0	103,0	61,0	48,0	40,0	56853	
0.3346	8,500 mm		10,0	103,0	61,0	48,0	40,0	69278	
0.3386	8,600 mm		10,0	103,0	61,0	48,0	40,0	69279	
0.3425	8,700 mm		10,0	103,0	61,0	48,0	40,0	69280	
0.3438	8,733 mm	11/32	10,0	103,0	61,0	48,0	40,0	56854	
0.3465	8,800 mm		10,0	103,0	61,0	48,0	40,0	69281	
0.3504	8,900 mm		10,0	103,0	61,0	48,0	40,0	69282	
0.3543	9,000 mm		10,0	103,0	61,0	48,0	40,0	69283	
0.3583	9,100 mm		10,0	103,0	61,0	47,0	40,0	69284	
0.3594	9,129 mm	23/64	10,0	103,0	61,0	47,0	40,0	56855	
0.3622	9,200 mm		10,0	103,0	61,0	47,0	40,0	69285	
0.3661	9,300 mm		10,0	103,0	61,0	47,0	40,0	69286	
0.3680	9,347 mm	U	10,0	103,0	61,0	47,0	40,0	56856	
0.3701	9,400 mm		10,0	103,0	61,0	47,0	40,0	69287	
0.3740	9,500 mm		10,0	103,0	61,0	47,0	40,0	69288	
0.3750	9,525 mm	3/8	10,0	103,0	61,0	47,0	40,0	56857	

TOLERANCES (inch)

≤.1181 DIAMETER

DC = +.0008/+0.0047
DCON = h₆

>.1181-.2362 DIAMETER

DC = +.00016/+0.00063
DCON = h₆

>.2362-.3937 DIAMETER

DC = +.00024/+0.00083
DCON = h₆

>.3937-.7087 DIAMETER

DC = +.00028/+0.00098
DCON = h₆

>.7087-1.1811 DIAMETER

DC = +.00031/+0.00114
DCON = h₆

TOLERANCES (mm)

≤3 DIAMETER

DC = +0,002/+0,012
DCON = h₆

>3-6 DIAMETER

DC = +0,004/+0,016
DCON = h₆

>6-10 DIAMETER

DC = +0,006/+0,021
DCON = h₆

>10-18 DIAMETER

DC = +0,007/+0,025
DCON = h₆

>18-30 DIAMETER

DC = +0,008/+0,029
DCON = h₆

- STEELS
- STAINLESS STEELS
- CAST IRON
- HIGH TEMP ALLOYS

For patent information visit www.ksptpatents.com

continued on next page



FRACTIONAL & METRIC
Series 143M-S

143M-S 5xD
 FRACTIONAL & METRIC SERIES

DECIMAL DC	METRIC DC	inch & mm						EDP NO.
		FRACTIONAL/ LETTER/WIRE DC	SHANK DIAMETER DCON	OVERALL LENGTH OAL	FLUTE LENGTH LCF	USABLE LENGTH LU	SHANK LENGTH LS	Ti-NAMITE®-A (AITIN)
0.3780	9,600 mm		10,0	103,0	61,0	47,0	40,0	69289
0.3819	9,700 mm		10,0	103,0	61,0	46,0	40,0	69290
0.3858	9,800 mm		10,0	103,0	61,0	46,0	40,0	69291
0.3898	9,900 mm		10,0	103,0	61,0	46,0	40,0	69292
0.3906	9,921 mm	25/64	10,0	103,0	61,0	46,0	40,0	56858
0.3937	10,000 mm		10,0	103,0	61,0	46,0	40,0	69293
0.3976	10,100 mm		12,0	118,0	71,0	56,0	45,0	69294
0.4016	10,200 mm		12,0	118,0	71,0	56,0	45,0	69295
0.4055	10,300 mm		12,0	118,0	71,0	56,0	45,0	69296
0.4062	10,317 mm	13/32	12,0	118,0	71,0	56,0	45,0	56859
0.4095	10,400 mm		12,0	118,0	71,0	55,0	45,0	69297
0.4134	10,500 mm		12,0	118,0	71,0	55,0	45,0	69298
0.4173	10,600 mm		12,0	118,0	71,0	55,0	45,0	69299
0.4213	10,700 mm		12,0	118,0	71,0	55,0	45,0	69300
0.4219	10,716 mm	27/64	12,0	118,0	71,0	55,0	45,0	56860
0.4252	10,800 mm		12,0	118,0	71,0	55,0	45,0	69301
0.4291	10,900 mm		12,0	118,0	71,0	55,0	45,0	69302
0.4331	11,000 mm		12,0	118,0	71,0	54,0	45,0	69303
0.4370	11,100 mm		12,0	118,0	71,0	54,0	45,0	69304
0.4375	11,113 mm	7/16	12,0	118,0	71,0	54,0	45,0	56861
0.4409	11,200 mm		12,0	118,0	71,0	54,0	45,0	69305
0.4449	11,300 mm		12,0	118,0	71,0	54,0	45,0	69306
0.4488	11,400 mm		12,0	118,0	71,0	54,0	45,0	69307
0.4528	11,500 mm		12,0	118,0	71,0	54,0	45,0	69308
0.4567	11,600 mm		12,0	118,0	71,0	54,0	45,0	69309
0.4606	11,700 mm		12,0	118,0	71,0	53,0	45,0	69310
0.4646	11,800 mm		12,0	118,0	71,0	53,0	45,0	69311
0.4685	11,900 mm		12,0	118,0	71,0	53,0	45,0	69312
0.4688	11,908 mm	15/32	12,0	118,0	71,0	53,0	45,0	56862
0.4724	12,000 mm		12,0	118,0	71,0	53,0	45,0	69313
0.4844	12,304 mm	31/64	14,0	124,0	77,0	58,0	45,0	56863
0.4921	12,500 mm		14,0	124,0	77,0	58,0	45,0	69314
0.5000	12,700 mm	1/2	14,0	124,0	77,0	58,0	45,0	56864
0.5039	12,800 mm		14,0	124,0	77,0	58,0	45,0	69315
0.5118	13,000 mm		14,0	124,0	77,0	58,0	45,0	69316
0.5156	13,096 mm	33/64	14,0	124,0	77,0	57,0	45,0	56865
0.5315	13,500 mm		14,0	124,0	77,0	57,0	45,0	69317
0.5433	13,800 mm		14,0	124,0	77,0	56,0	45,0	69318
0.5512	14,000 mm		14,0	124,0	77,0	56,0	45,0	69319
0.5625	14,288 mm	9/16	16,0	133,0	83,0	61,0	48,0	56866
0.5709	14,500 mm		16,0	133,0	83,0	61,0	48,0	69320
0.5781	14,684 mm	37/64	16,0	133,0	83,0	61,0	48,0	56867
0.5827	14,800 mm		16,0	133,0	83,0	61,0	48,0	69321
0.5906	15,000 mm		16,0	133,0	83,0	60,0	48,0	69322
0.6102	15,500 mm		16,0	133,0	83,0	60,0	48,0	69323
0.6221	15,800 mm		16,0	133,0	83,0	59,0	48,0	69324
0.6250	15,875 mm	5/8	16,0	133,0	83,0	59,0	48,0	56868
0.6299	16,000 mm		16,0	133,0	83,0	59,0	48,0	69325
0.6562	16,667 mm	21/32	18,0	143,0	93,0	68,0	48,0	56869
0.6875	17,463 mm	11/16	18,0	143,0	93,0	67,0	48,0	56870
0.7500	19,050 mm	3/4	20,0	153,0	101,0	72,0	50,0	56871

CONTINUED

Series 143M-S 5xD
 Fractional & Metric

FRACTIONAL
Series 143M-S



Series 143M-S Speed & Feed Recommendations

Series 143M-S Fractional	Hardness	Vc (sfm)	DC • in							
			1/8	3/16	1/4	3/8	1/2	5/8	3/4	
CARBON STEELS 1018, 1040, 1080, 1090, 10L50, 1140, 1212, 12L15, 1525, 1536	≤ 175 Bhn or ≤ 7 HRc	425	RPM	12988	8659	6494	4329	3247	2598	2165
		(340-510)	Fr	0.0039	0.0059	0.0079	0.0118	0.0157	0.0196	0.0236
			Feed (ipm)	51.0	51.0	51.0	51.0	51.0	51.0	51.0
	≤ 275 Bhn or ≤ 28 HRc	380	RPM	11613	7742	5806	3871	2903	2323	1935
		(304-456)	Fr	0.0035	0.0053	0.0071	0.0106	0.0141	0.0177	0.0212
			Feed (ipm)	41.0	41.0	41.0	41.0	41.0	41.0	41.0
	≤ 425 Bhn or ≤ 45 HRc	220	RPM	6723	4482	3362	2241	1681	1345	1121
		(176-264)	Fr	0.0030	0.0045	0.0059	0.0089	0.0119	0.0149	0.0178
			Feed (ipm)	20.0	20.0	20.0	20.0	20.0	20.0	20.0
P ALLOY STEELS 4140, 4150, 4320, 5120, 5150, 8630, 86L20, 50100	≤ 275 Bhn or ≤ 28 HRc	330	RPM	10085	6723	5042	3362	2521	2017	1681
		(264-396)	Fr	0.0030	0.0045	0.0059	0.0089	0.0119	0.0149	0.0178
			Feed (ipm)	30.0	30.0	30.0	30.0	30.0	30.0	30.0
	≤ 375 Bhn or ≤ 40 HRc	200	RPM	6112	4075	3056	2037	1528	1222	1019
		(160-240)	Fr	0.0025	0.0038	0.0051	0.0076	0.0101	0.0127	0.0152
			Feed (ipm)	15.5	15.5	15.5	15.5	15.5	15.5	15.5
	≤ 425 Bhn or ≤ 45 HRc	140	RPM	4278	2852	2139	1426	1070	856	713
		(112-168)	Fr	0.0018	0.0027	0.0036	0.0054	0.0072	0.0090	0.0108
			Feed (ipm)	7.7	7.7	7.7	7.7	7.7	7.7	7.7
TOOL STEELS A2, D2, H13, L2, M2, P20, S7, T15, W2	≤ 200 Bhn or ≤ 13 HRc	145	RPM	4431	2954	2216	1477	1108	886	739
		(116-174)	Fr	0.0026	0.0039	0.0052	0.0078	0.0104	0.0130	0.0156
			Feed (ipm)	11.5	11.5	11.5	11.5	11.5	11.5	11.5
	≤ 375 Bhn or ≤ 40 HRc	95	RPM	2903	1935	1452	968	726	581	484
		(76-114)	Fr	0.0012	0.0018	0.0024	0.0036	0.0048	0.0060	0.0072
			Feed (ipm)	3.5	3.5	3.5	3.5	3.5	3.5	3.5
M STAINLESS STEELS (FREE MACHINING) 303, 416, 420F, 430F, 440F	≤ 185 Bhn or ≤ 9 HRc	325	RPM	9932	6621	4966	3311	2483	1986	1655
		(260-390)	Fr	0.0030	0.0045	0.0060	0.0091	0.0121	0.0151	0.0181
			Feed (ipm)	30.0	30.0	30.0	30.0	30.0	30.0	30.0
	≤ 275 Bhn or ≤ 28 HRc	210	RPM	6418	4278	3209	2139	1604	1284	1070
		(168-252)	Fr	0.0023	0.0035	0.0047	0.0070	0.0093	0.0117	0.0140
			Feed (ipm)	15.0	15.0	15.0	15.0	15.0	15.0	15.0
	≤ 275 Bhn or ≤ 28 HRc	160	RPM	4890	3260	2445	1630	1222	978	815
		(128-192)	Fr	0.0023	0.0035	0.0047	0.0070	0.0093	0.0117	0.0140
			Feed (ipm)	11.4	11.4	11.4	11.4	11.4	11.4	11.4
≤ 375 Bhn or ≤ 40 HRc	115	RPM	3514	2343	1757	1171	879	703	586	
	(92-138)	Fr	0.0021	0.0031	0.0042	0.0062	0.0083	0.0104	0.0125	
		Feed (ipm)	7.3	7.3	7.3	7.3	7.3	7.3	7.3	

continued on next page

Series 143M-S Fractional		Hardness	Vc (sfm)	DC • in							
				1/8	3/16	1/4	3/8	1/2	5/8	3/4	
K	CAST IRONS Gray, Malleable, Ductile	≤ 220 Bhn or ≤ 19 HRc	360	RPM	11002	7334	5501	3667	2750	2200	1834
			(288-432)	Fr	0.0045	0.0068	0.0091	0.0136	0.0182	0.0227	0.0273
				Feed (ipm)	50.0	50.0	50.0	50.0	50.0	50.0	50.0
		≤ 260 Bhn or ≤ 26 HRc	335	RPM	10238	6825	5119	3413	2559	2048	1706
			(268-402)	Fr	0.0045	0.0068	0.0091	0.0136	0.0182	0.0227	0.0273
				Feed (ipm)	46.5	46.5	46.5	46.5	46.5	46.5	46.5
S	HIGH TEMP ALLOYS (NICKEL, COBALT, IRON BASE) Inconel 601, 617, 625, Incoloy, Monel 400, Rene, Waspaloy	≤ 300 Bhn or ≤ 32 HRc	130	RPM	3973	2649	1986	1324	993	795	662
			(104-156)	Fr	0.0014	0.0022	0.0029	0.0043	0.0057	0.0072	0.0086
				Feed (ipm)	5.7	5.7	5.7	5.7	5.7	5.7	5.7
		≤ 400 Bhn or ≤ 43 HRc	70	RPM	2139	1426	1070	713	535	428	357
			(56-84)	Fr	0.0012	0.0018	0.0024	0.0036	0.0049	0.0061	0.0073
				Feed (ipm)	2.6	2.6	2.6	2.6	2.6	2.6	2.6
S	TITANIUM ALLOYS Pure Titanium, Ti6Al4V, Ti6Al2Sn4Zr2Mo, Ti4Al4Mo2Sn0.5Si, Ti-6Al4V	≤ 275 Bhn or ≤ 28 HRc	215	RPM	6570	4380	3285	2190	1643	1314	1095
			(172-258)	Fr	0.0018	0.0026	0.0035	0.0053	0.0070	0.0088	0.0105
				Feed (ipm)	11.5	11.5	11.5	11.5	11.5	11.5	11.5
		≤ 350 Bhn or ≤ 38 HRc	160	RPM	4890	3260	2445	1630	1222	978	815
			(128-192)	Fr	0.0016	0.0024	0.0032	0.0048	0.0064	0.0080	0.0096
				Feed (ipm)	7.8	7.8	7.8	7.8	7.8	7.8	7.8
≤ 440 Bhn or ≤ 47 HRc	85	RPM	2598	1732	1299	866	649	520	433		
	(68-102)	Fr	0.0012	0.0018	0.0024	0.0036	0.0048	0.0060	0.0072		
		Feed (ipm)	3.1	3.1	3.1	3.1	3.1	3.1	3.1		

Bhn (Brinell) HRc (Rockwell C) HRb (Rockwell B)

rpm = Vc x 3.82 / DC

ipm = Fr x RPM

reduce speed and feed for materials harder than listed

refer to the SGS Tool Wizard® for complete technical information (www.kyocera-sgstool.com)

Series 143M-S



Series 143M-S Speed & Feed Recommendations

Series 143M-S Metric	Hardness	Vc (m/min)	DC • mm								
			3	6	8	10	12	14	16		
CARBON STEELS 1018, 1040, 1080, 1090, 10L50, 1140, 1212, 12L15, 1525, 1536	≤ 175 Bhn or ≤ 7 HRc	130	RPM	13733	6867	5150	4120	3433	2943	2575	
		(104-155)	Fr	0.094	0.189	0.252	0.314	0.377	0.440	0.503	
			Feed (mm/min)	1295	1295	1295	1295	1295	1295	1295	
	≤ 275 Bhn or ≤ 28 HRc	116	RPM	12279	6140	4605	3684	3070	2631	2302	
		(93-139)	Fr	0.085	0.170	0.226	0.283	0.339	0.396	0.452	
			Feed (mm/min)	1041	1041	1041	1041	1041	1041	1041	
	≤ 425 Bhn or ≤ 45 HRc	67	RPM	7109	3555	2666	2133	1777	1523	1333	
		(54-80)	Fr	0.071	0.143	0.191	0.238	0.286	0.333	0.381	
			Feed (mm/min)	508	508	508	508	508	508	508	
	ALLOY STEELS 4140, 4150, 4320, 5120, 5150, 8630, 86L20, 50100	≤ 275 Bhn or ≤ 28 HRc	101	RPM	10664	5332	3999	3199	2666	2285	1999
			(80-121)	Fr	0.071	0.143	0.191	0.238	0.286	0.333	0.381
				Feed (mm/min)	762	762	762	762	762	762	762
≤ 375 Bhn or ≤ 40 HRc		61	RPM	6463	3231	2424	1939	1616	1385	1212	
		(49-73)	Fr	0.061	0.122	0.162	0.203	0.244	0.284	0.325	
			Feed (mm/min)	394	394	394	394	394	394	394	
≤ 425 Bhn or ≤ 45 HRc		43	RPM	4524	2262	1696	1357	1131	969	848	
		(34-51)	Fr	0.043	0.086	0.115	0.144	0.173	0.202	0.231	
			Feed (mm/min)	196	196	196	196	196	196	196	
TOOL STEELS A2, D2, H13, L2, M2, P20, S7, T15, W2		≤ 200 Bhn or ≤ 13 HRc	44	RPM	4686	2343	1757	1406	1171	1004	879
			(35-53)	Fr	0.062	0.125	0.166	0.208	0.249	0.291	0.332
				Feed (mm/min)	292	292	292	292	292	292	292
	≤ 375 Bhn or ≤ 40 HRc	29	RPM	3070	1535	1151	921	767	658	576	
		(23-35)	Fr	0.029	0.058	0.077	0.097	0.116	0.135	0.154	
			Feed (mm/min)	89	89	89	89	89	89	89	
STAINLESS STEELS (FREE MACHINING) 303, 416, 420F, 430F, 440F	≤ 185 Bhn or ≤ 9 HRc	99	RPM	10502	5251	3938	3151	2626	2250	1969	
		(79-119)	Fr	0.073	0.145	0.193	0.242	0.290	0.339	0.387	
			Feed (mm/min)	762	762	762	762	762	762	762	
	≤ 275 Bhn or ≤ 28 HRc	64	RPM	6786	3393	2545	2036	1696	1454	1272	
		(51-77)	Fr	0.056	0.112	0.150	0.187	0.225	0.262	0.299	
			Feed (mm/min)	381	381	381	381	381	381	381	
STAINLESS STEELS (DIFFICULT) 304, 316, 321, 13-8 PH, 15-5PH, 17-4 PH, Custom 450	≤ 275 Bhn or ≤ 28 HRc	49	RPM	5170	2585	1939	1551	1293	1108	969	
		(39-59)	Fr	0.056	0.112	0.149	0.187	0.224	0.261	0.299	
			Feed (mm/min)	290	290	290	290	290	290	290	
	≤ 375 Bhn or ≤ 40 HRc	35	RPM	3716	1858	1394	1115	929	796	697	
		(28-42)	Fr	0.050	0.100	0.133	0.166	0.200	0.233	0.266	
			Feed (mm/min)	185	185	185	185	185	185	185	

continued on next page

Series 143M-S Metric	Hardness	Vc (m/min)		DC • mm						
				3	6	8	10	12	14	16
K	CAST IRONS Gray, Malleable, Ductile	110 (88-132)	RPM	11633	5816	4362	3490	2908	2493	2181
			Fr	0.109	0.218	0.291	0.364	0.437	0.509	0.582
			Feed (mm/min)	1270	1270	1270	1270	1270	1270	1270
		102 (82-123)	RPM	10825	5413	4059	3248	2706	2320	2030
			Fr	0.109	0.218	0.291	0.364	0.436	0.509	0.582
			Feed (mm/min)	1181	1181	1181	1181	1181	1181	1181
S	HIGH TEMP ALLOYS (Nickel , Cobalt, Iron Base) Inconel 601, 617, 625, Incoloy, Monel 400, Rene, Waspaloy	40 (32-48)	RPM	4201	2100	1575	1260	1050	900	788
			Fr	0.034	0.069	0.092	0.115	0.138	0.161	0.184
			Feed (mm/min)	145	145	145	145	145	145	145
		21 (17-26)	RPM	2262	1131	848	679	565	485	424
			Fr	0.029	0.058	0.078	0.097	0.117	0.136	0.156
			Feed (mm/min)	66	66	66	66	66	66	66
	TITANIUM ALLOYS Pure Titanium, Ti6Al4V, Ti6Al2Sn4Zr2Mo, Ti4Al4Mo2Sn0.5Si, Ti-6Al4V	66 (52-79)	RPM	6947	3474	2605	2084	1737	1489	1303
			Fr	0.042	0.084	0.112	0.140	0.168	0.196	0.224
			Feed (mm/min)	292	292	292	292	292	292	292
		49 (39-59)	RPM	5170	2585	1939	1551	1293	1108	969
			Fr	0.038	0.077	0.102	0.128	0.153	0.179	0.204
			Feed (mm/min)	198	198	198	198	198	198	198
26 (21-31)	RPM	2747	1373	1030	824	687	589	515		
	Fr	0.029	0.057	0.076	0.096	0.115	0.134	0.153		
	Feed (mm/min)	79	79	79	79	79	79	79		

Bhn (Brinell) HRC (Rockwell C) HRB (Rockwell B)
 rpm = (Vc x 1000) / (DC x 3.14)
 mm/min = Fr x RPM
 reduce speed and feed for materials harder than listed
 refer to the SGS Tool Wizard® for complete technical information (www.kyocera-sgstool.com)

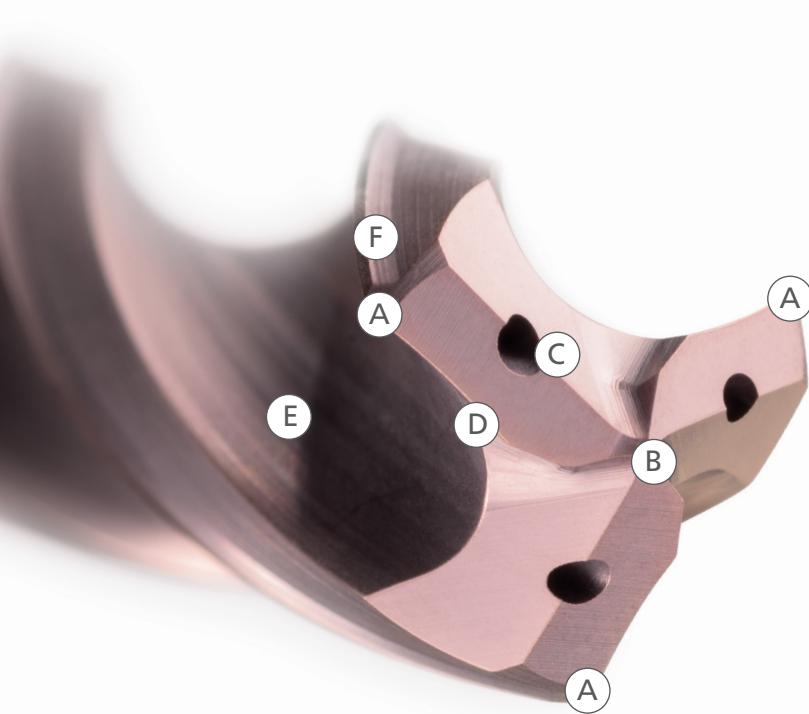

SERIES 141K

- (A) 3-MARGIN DESIGN**
- improved hole stability over two-flute designs
 - superior surface finish, roundness, and hole cylindricity
 - unsurpassed hole size control

- (B) SELF-STABILIZING POINT AND OPEN FLUTE STRUCTURE**
- pyramid design stabilizes the drill on contact with the workpiece
 - engineered flute shape efficiently transports chip volume without sacrificing strength

- (C) COOLANT THROUGH DESIGN**
- puts coolant as close to cut as possible for consistent chip flushing, maximum cooling, and highest productivity

- (D) EDGE AND CORNER PROTECTION**
- corner chamfers provide strength and reduce breakout when drilling through holes in cast iron
 - automated edge treatment process extends tool life by eliminating microscopic imperfections in the cutting edges

- (E) APPLICATION SPECIFIC COATING AND PREMIUM CARBIDE**
- Ti-NAMITE[®]-M is a state-of-the-art nano-composite surface coating that maximizes wear resistance in abrasive cast irons
 - 141K drills are manufactured from premium certified carbide to further ensure the highest level of quality, performance, and longevity

- (F) MINIMAL MARGIN DESIGN**
- a narrow margin reduces frictional heat generated by excessive contact with the workpiece, and the parallel design helps to maintain a consistent contact width as the margins wear



HIGH PERFORMANCE CARBIDE DRILLS

The key features designed into the Hi-PerCarb[®] Series 141K Drill allow the product to offer application benefits not only beyond that of standard carbide drills, but also other High Performance drills. Each feature of the Hi-PerCarb[®] Series 141K Drill was uniquely engineered as a solution towards addressing the issues commonly encountered during high production drilling.

PERFORMANCE. PRECISION. PASSION.
HI-PERCARB[®] SERIES 141K CAST IRON DRILLS

PERFORMANCE.

FORCE COMPARISON

Series 141K drills with 20% less force than the top competitors

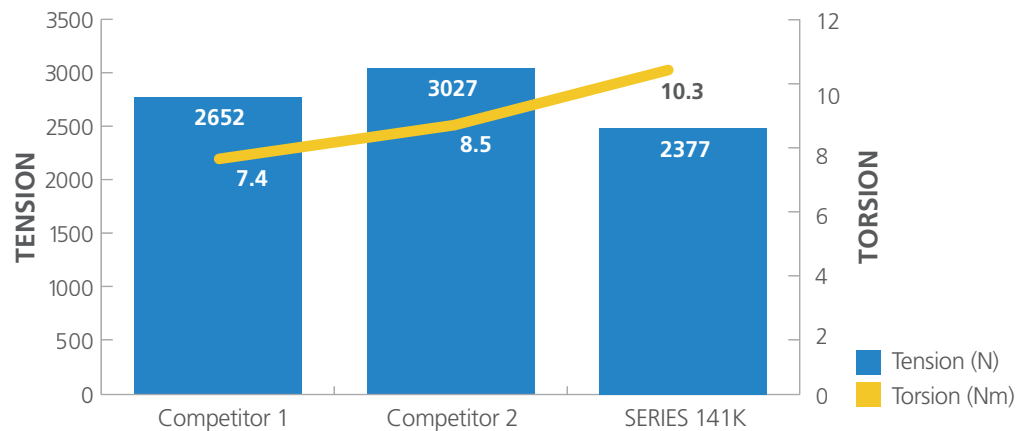

SURFACE FINISH COMPARISON

Series 141K drill results in improvement of hole finishes 40-50% over leading competitors

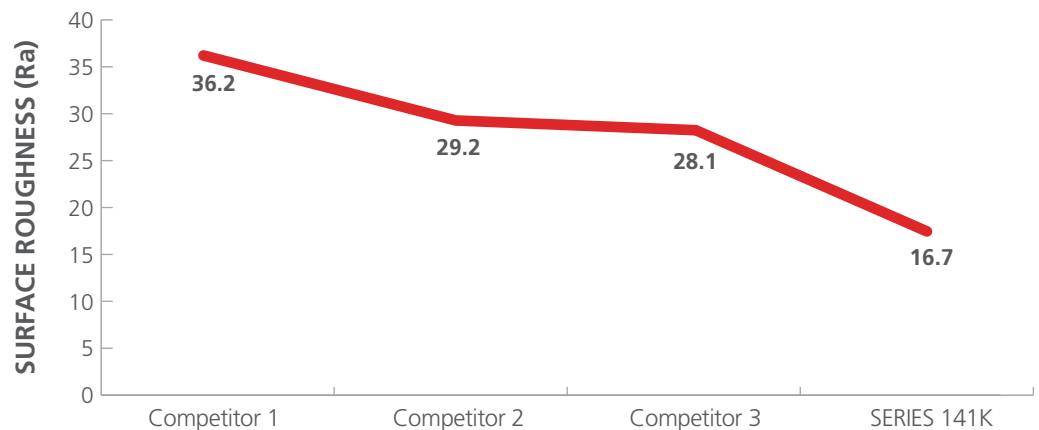

USAGE & WEAR COMPARISONS

Series 141K drill results in 50% tool life improvement over a range of leading competitors

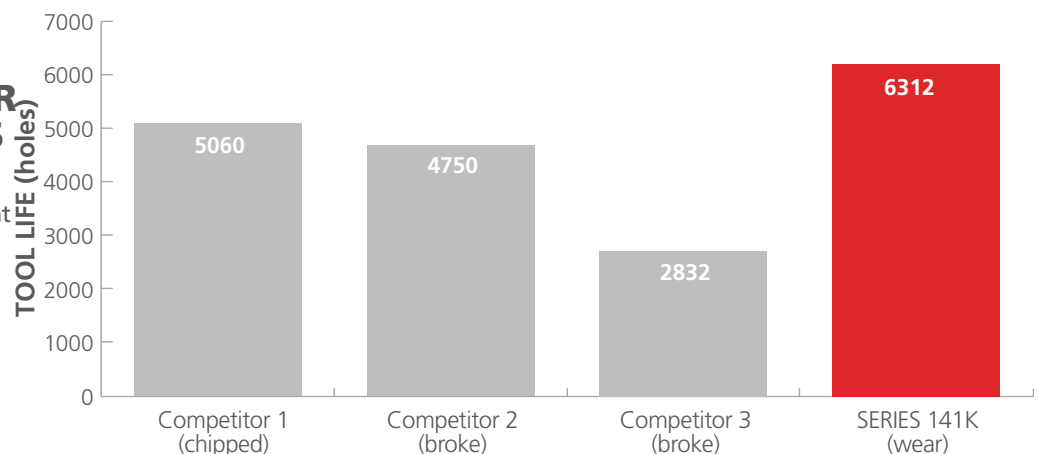

PRECISION.

SERIES 141K Hole Size Comparison vs. Competition in Class 40 Cast Iron

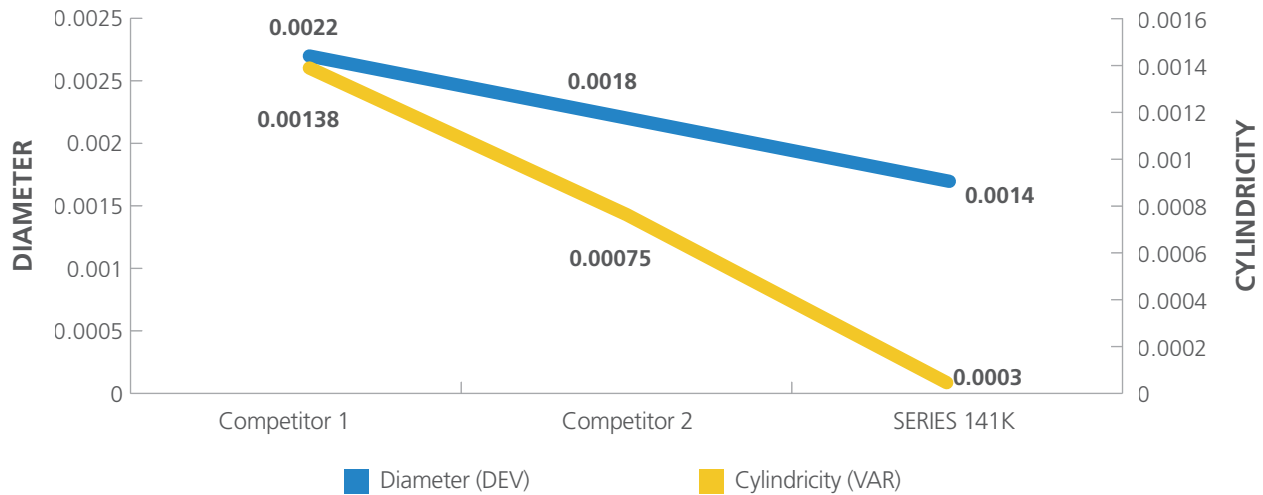

PASSION.

Lab Results Indicate the Hi-Per Carb® Series 141K Drill outperforms the competition in measured hole quality at a variety of speed and feed rates.

Ti-NAMITE®-M

Features of Ti-NAMITE®-M include high wear resistance, reduced friction, and excellent prevention of cutting edge build up. This coating allows superior material removal rates and tool life when used in high performance operations in Cast Iron and Steel and with difficult to machine materials like Titanium.

Hardness (HV): 3600

Oxidation Temperature: 1150°C / 2100°F

Coefficient of Friction: 0.45

Thickness: 1-4 Microns (based on tool diameter)



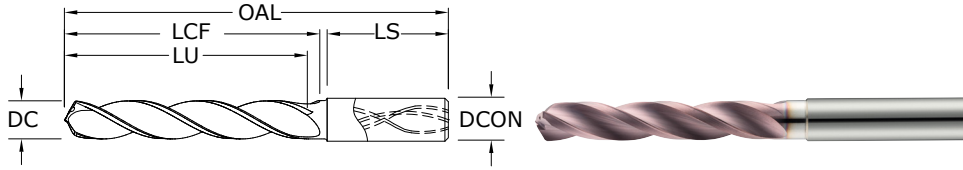

141K 5xD
FRACTIONAL & METRIC SERIES

TOLERANCES (inch)

≤.1181 DIAMETER
DC = +.00008/+0.00047
DCON = h₆

>.1181–.2362 DIAMETER
DC = +.00016/+0.00063
DCON = h₆

>.2362–.3937 DIAMETER
DC = +.00024/+0.00083
DCON = h₆

>.3937–.7087 DIAMETER
DC = +.00028/+0.00098
DCON = h₆

>.7087–1.1811 DIAMETER
DC = +.00031/+0.00114
DCON = h₆

TOLERANCES (mm)

≤3 DIAMETER
DC = +0,002/+0,012
DCON = h₆

>3–6 DIAMETER
DC = +0,004/+0,016
DCON = h₆

>6–10 DIAMETER
DC = +0,006/+0,021
DCON = h₆

>10–18 DIAMETER
DC = +0,007/+0,025
DCON = h₆

>18–30 DIAMETER
DC = +0,008/+0,029
DCON = h₆

CAST IRON

For patent information visit www.ksptpatents.com

		inch & mm							EDP NO.
DECIMAL DC	METRIC DC	FRACTIONAL/ LETTER/WIRE DC	SHANK DIAMETER DCON	OVERALL LENGTH OAL	FLUTE LENGTH LCF	USABLE LENGTH LU	SHANK LENGTH LS	Ti-NAMITE®-M (TM)	
0.1181	3,000 mm		6,0	66,0	28,0	23,0	36,0	65160	
0.1220	3,100 mm		6,0	66,0	28,0	23,0	36,0	65161	
0.1250	3,175 mm	1/8	6,0	66,0	28,0	23,0	36,0	55160	
0.1260	3,200 mm		6,0	66,0	28,0	23,0	36,0	65162	
0.1299	3,300 mm		6,0	66,0	28,0	23,0	36,0	65163	
0.1339	3,400 mm		6,0	66,0	28,0	23,0	36,0	65164	
0.1360	3,454 mm	#29	6,0	66,0	28,0	23,0	36,0	55161	
0.1378	3,500 mm		6,0	66,0	28,0	23,0	36,0	65165	
0.1406	3,571 mm	9/64	6,0	66,0	28,0	23,0	36,0	55162	
0.1417	3,600 mm		6,0	66,0	28,0	23,0	36,0	65166	
0.1457	3,700 mm		6,0	66,0	28,0	23,0	36,0	65167	
0.1496	3,800 mm		6,0	74,0	36,0	29,0	36,0	65168	
0.1535	3,900 mm		6,0	74,0	36,0	29,0	36,0	65169	
0.1562	3,967 mm	5/32	6,0	74,0	36,0	29,0	36,0	55163	
0.1575	4,000 mm		6,0	74,0	36,0	29,0	36,0	65170	
0.1590	4,039 mm	#21	6,0	74,0	36,0	29,0	36,0	55164	
0.1614	4,100 mm		6,0	74,0	36,0	29,0	36,0	65171	
0.1654	4,200 mm		6,0	74,0	36,0	29,0	36,0	65172	
0.1693	4,300 mm		6,0	74,0	36,0	29,0	36,0	65173	
0.1719	4,366 mm	11/64	6,0	74,0	36,0	29,0	36,0	55165	
0.1732	4,400 mm		6,0	74,0	36,0	29,0	36,0	65174	
0.1772	4,500 mm		6,0	74,0	36,0	29,0	36,0	65175	
0.1811	4,600 mm		6,0	74,0	36,0	29,0	36,0	65176	
0.1850	4,699 mm	#13	6,0	74,0	36,0	29,0	36,0	65177	
0.1875	4,763 mm	3/16	6,0	82,0	44,0	37,0	36,0	55166	
0.1890	4,801 mm	#12	6,0	82,0	44,0	37,0	36,0	65178	
0.1929	4,900 mm		6,0	82,0	44,0	37,0	36,0	65179	
0.1969	5,000 mm		6,0	82,0	44,0	36,0	36,0	65180	
0.2008	5,100 mm		6,0	82,0	44,0	36,0	36,0	65181	
0.2031	5,159 mm	13/64	6,0	82,0	44,0	36,0	36,0	55167	
0.2047	5,200 mm		6,0	82,0	44,0	36,0	36,0	65182	
0.2087	5,300 mm		6,0	82,0	44,0	36,0	36,0	65183	
0.2126	5,400 mm		6,0	82,0	44,0	36,0	36,0	65184	
0.2165	5,500 mm		6,0	82,0	44,0	36,0	36,0	65185	
0.2188	5,558 mm	7/32	6,0	82,0	44,0	36,0	36,0	55168	
0.2205	5,600 mm		6,0	82,0	44,0	36,0	36,0	65186	

continued on next page

- 3-margin design improves hole stability and size control while providing superior finish, roundness and cylindricity
- Self-stabilizing pyramid point design stabilizes the drill on contact with the workpiece
- Open flute structure efficiently transports chips while maintaining strength at high feed rates
- Sculpted gash allows chips to easily flow away from the drill center
- Recommended for materials ≤ 43 HRc (≤ 400 Bhn)

FRACTIONAL & METRIC Series 141K



141K 5xD

FRACTIONAL & METRIC SERIES

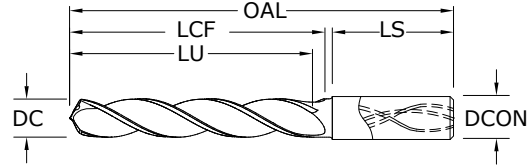

Series 141K 5xD Fractional & Metric

- 3-margin design improves hole stability and size control while providing superior finish, roundness and cylindricity
- Self-stabilizing pyramid point design stabilizes the drill on contact with the workpiece
- Open flute structure efficiently transports chips while maintaining strength at high feed rates
- Sculpted gash allows chips to easily flow away from the drill center
- Recommended for materials ≤ 43 HRc (≤ 400 Bhn)

		inch & mm						EDP NO.
DECIMAL DC	METRIC DC	FRACTIONAL/ LETTER/WIRE DC	SHANK DIAMETER DCON	OVERALL LENGTH OAL	FLUTE LENGTH LCF	USABLE LENGTH LU	SHANK LENGTH LS	Ti-NAMITE®-M (TM)
0.2244	5,700 mm		6,0	82,0	44,0	35,0	36,0	65187
0.2283	5,800 mm		6,0	82,0	44,0	35,0	36,0	65188
0.2323	5,900 mm		6,0	82,0	44,0	35,0	36,0	65189
0.2344	5,954 mm	15/64	6,0	82,0	44,0	35,0	36,0	55169
0.2362	6,000 mm		6,0	82,0	44,0	35,0	36,0	65190
0.2402	6,100 mm		8,0	91,0	53,0	44,0	36,0	65191
0.2441	6,200 mm		8,0	91,0	53,0	44,0	36,0	65192
0.2480	6,300 mm		8,0	91,0	53,0	44,0	36,0	65193
0.2500	6,350 mm	1/4 E #0	8,0	91,0	53,0	43,0	36,0	55170
0.2520	6,400 mm		8,0	91,0	53,0	43,0	36,0	65194
0.2559	6,500 mm		8,0	91,0	53,0	43,0	36,0	65195
0.2570	6,528 mm	F	8,0	91,0	53,0	43,0	36,0	55171
0.2598	6,600 mm		8,0	91,0	53,0	43,0	36,0	65196
0.2638	6,700 mm		8,0	91,0	53,0	43,0	36,0	65197
0.2656	6,746 mm	17/64	8,0	91,0	53,0	43,0	36,0	55172
0.2677	6,800 mm		8,0	91,0	53,0	43,0	36,0	65198
0.2717	6,900 mm		8,0	91,0	53,0	43,0	36,0	65199
0.2756	7,000 mm		8,0	91,0	53,0	42,0	36,0	65200
0.2795	7,100 mm		8,0	91,0	53,0	42,0	36,0	65201
0.2812	7,142 mm	9/32	8,0	91,0	53,0	42,0	36,0	55173
0.2835	7,200 mm		8,0	91,0	53,0	42,0	36,0	65202
0.2874	7,300 mm		8,0	91,0	53,0	42,0	36,0	65203
0.2913	7,400 mm		8,0	91,0	53,0	42,0	36,0	65204
0.2953	7,500 mm		8,0	91,0	53,0	42,0	36,0	65205
0.2969	7,541 mm	19/64	8,0	91,0	53,0	42,0	36,0	55174
0.2992	7,600 mm		8,0	91,0	53,0	42,0	36,0	65206
0.3031	7,700 mm		8,0	91,0	53,0	41,0	36,0	65207
0.3071	7,800 mm		8,0	91,0	53,0	41,0	36,0	65208
0.3110	7,900 mm		8,0	91,0	53,0	41,0	36,0	65209
0.3125	7,938 mm	5/16	8,0	91,0	53,0	41,0	36,0	55175
0.3150	8,000 mm		8,0	91,0	53,0	41,0	36,0	65210
0.3189	8,100 mm		10,0	103,0	61,0	49,0	40,0	65211
0.3228	8,200 mm		10,0	103,0	61,0	49,0	40,0	65212
0.3268	8,300 mm		10,0	103,0	61,0	49,0	40,0	65213
0.3281	8,334 mm	21/64	10,0	103,0	61,0	48,0	40,0	55176
0.3307	8,400 mm		10,0	103,0	61,0	48,0	40,0	65214
0.3320	8,433 mm	Q	10,0	103,0	61,0	48,0	40,0	55177
0.3346	8,500 mm		10,0	103,0	61,0	48,0	40,0	65215

TOLERANCES (inch)

≤.1181 DIAMETER

DC = +.00008/+0.00047
DCON = h₆

>.1181-.2362 DIAMETER

DC = +.00016/+0.00063
DCON = h₆

>.2362-.3937 DIAMETER

DC = +.00024/+0.00083
DCON = h₆

>.3937-.7087 DIAMETER

DC = +.00028/+0.00098
DCON = h₆

>.7087-1.1811 DIAMETER

DC = +.00031/+0.00114
DCON = h₆

TOLERANCES (mm)

≤3 DIAMETER

DC = +0,002/+0,012
DCON = h₆

>3-6 DIAMETER

DC = +0,004/+0,016
DCON = h₆

>6-10 DIAMETER

DC = +0,006/+0,021
DCON = h₆

>10-18 DIAMETER

DC = +0,007/+0,025
DCON = h₆

CAST IRON

For patent information visit www.ksptpatents.com

continued on next page



FRACTIONAL & METRIC Series 141K

141K 5xD

FRACTIONAL & METRIC SERIES

DECIMAL DC	METRIC DC	inch & mm						EDP NO.
		FRACTIONAL/ LETTER/WIRE DC	SHANK DIAMETER DCON	OVERALL LENGTH OAL	FLUTE LENGTH LCF	USABLE LENGTH LU	SHANK LENGTH LS	Ti-NAMITE®-M (TM)
0.3386	8,600 mm		10,0	103,0	61,0	48,0	40,0	65216
0.3425	8,700 mm		10,0	103,0	61,0	48,0	40,0	65217
0.3438	8,733 mm	11/32	10,0	103,0	61,0	48,0	40,0	55178
0.3465	8,800 mm		10,0	103,0	61,0	48,0	40,0	65218
0.3504	8,900 mm		10,0	103,0	61,0	48,0	40,0	65219
0.3543	9,000 mm		10,0	103,0	61,0	48,0	40,0	65220
0.3583	9,100 mm		10,0	103,0	61,0	47,0	40,0	65221
0.3594	9,129 mm	23/64	10,0	103,0	61,0	47,0	40,0	55179
0.3622	9,200 mm		10,0	103,0	61,0	47,0	40,0	65222
0.3661	9,300 mm		10,0	103,0	61,0	47,0	40,0	65223
0.3680	9,347 mm	U	10,0	103,0	61,0	47,0	40,0	55180
0.3701	9,400 mm		10,0	103,0	61,0	47,0	40,0	65224
0.3740	9,500 mm		10,0	103,0	61,0	47,0	40,0	65225
0.3750	9,525 mm	3/8	10,0	103,0	61,0	47,0	40,0	55181
0.3780	9,600 mm		10,0	103,0	61,0	47,0	40,0	65226
0.3819	9,700 mm		10,0	103,0	61,0	46,0	40,0	65227
0.3858	9,800 mm		10,0	103,0	61,0	46,0	40,0	65228
0.3898	9,900 mm		10,0	103,0	61,0	46,0	40,0	65229
0.3906	9,921 mm	25/64	10,0	103,0	61,0	46,0	40,0	55182
0.3937	10,000 mm		10,0	103,0	61,0	46,0	40,0	65230
0.3976	10,100 mm		12,0	118,0	71,0	56,0	45,0	65231
0.4016	10,200 mm		12,0	118,0	71,0	56,0	45,0	65232
0.4055	10,300 mm		12,0	118,0	71,0	56,0	45,0	65233
0.4062	10,317 mm	13/32	12,0	118,0	71,0	56,0	45,0	55183
0.4095	10,400 mm		12,0	118,0	71,0	55,0	45,0	65234
0.4134	10,500 mm		12,0	118,0	71,0	55,0	45,0	65235
0.4173	10,600 mm		12,0	118,0	71,0	55,0	45,0	65236
0.4213	10,700 mm		12,0	118,0	71,0	55,0	45,0	65237
0.4219	10,716 mm	27/64	12,0	118,0	71,0	55,0	45,0	55184
0.4252	10,800 mm		12,0	118,0	71,0	55,0	45,0	65238
0.4291	10,900 mm		12,0	118,0	71,0	55,0	45,0	65239
0.4331	11,000 mm		12,0	118,0	71,0	54,0	45,0	65240
0.4370	11,100 mm		12,0	118,0	71,0	54,0	45,0	65241
0.4375	11,113 mm	7/16	12,0	118,0	71,0	54,0	45,0	55185
0.4409	11,200 mm		12,0	118,0	71,0	54,0	45,0	65242
0.4449	11,300 mm		12,0	118,0	71,0	54,0	45,0	65243
0.4488	11,400 mm		12,0	118,0	71,0	54,0	45,0	65244
0.4528	11,500 mm		12,0	118,0	71,0	54,0	45,0	65245
0.4567	11,600 mm		12,0	118,0	71,0	54,0	45,0	65246
0.4606	11,700 mm		12,0	118,0	71,0	53,0	45,0	65247
0.4646	11,800 mm		12,0	118,0	71,0	53,0	45,0	65248
0.4685	11,900 mm		12,0	118,0	71,0	53,0	45,0	65249
0.4688	11,908 mm	15/32	12,0	118,0	71,0	53,0	45,0	55186
0.4724	12,000 mm		12,0	118,0	71,0	53,0	45,0	65250

continued on next page

CONTINUED

Series 141K 5xD | Fractional & Metric

FRACTIONAL & METRIC Series 141K



141K 5xD

FRACTIONAL & METRIC SERIES

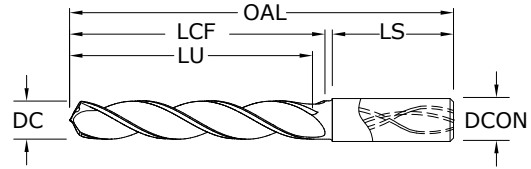

- 3-margin design improves hole stability and size control while providing superior finish, roundness and cylindricity
- Self-stabilizing pyramid point design stabilizes the drill on contact with the workpiece
- Open flute structure efficiently transports chips while maintaining strength at high feed rates
- Sculpted gash allows chips to easily flow away from the drill center
- Recommended for materials ≤ 43 HRc (≤ 400 Bhn)

inch & mm									EDP NO.
DECIMAL DC	METRIC DC	FRACTIONAL/ LETTER/WIRE DC	SHANK DIAMETER DCON	OVERALL LENGTH OAL	FLUTE LENGTH LCF	USABLE LENGTH LU	SHANK LENGTH LS	Ti-NAMITE [®] -M (TM)	
0.4844	12,304 mm	31/64	14,0	124,0	77,0	58,0	45,0	55187	
0.4921	12,500 mm		14,0	124,0	77,0	58,0	45,0	65251	
0.5000	12,700 mm	1/2	14,0	124,0	77,0	58,0	45,0	55188	
0.5039	12,800 mm		14,0	124,0	77,0	58,0	45,0	65252	
0.5118	13,000 mm		14,0	124,0	77,0	58,0	45,0	65253	
0.5156	13,096 mm	33/64	14,0	124,0	77,0	57,0	45,0	55189	
0.5315	13,500 mm		14,0	124,0	77,0	57,0	45,0	65254	
0.5433	13,800 mm		14,0	124,0	77,0	56,0	45,0	65255	
0.5512	14,000 mm		14,0	124,0	77,0	56,0	45,0	65256	
0.5625	14,288 mm	9/16	16,0	133,0	83,0	61,0	48,0	55190	
0.5709	14,500 mm		16,0	133,0	83,0	61,0	48,0	65257	
0.5781	14,684 mm	37/64	16,0	133,0	83,0	61,0	48,0	55191	
0.5827	14,800 mm		16,0	133,0	83,0	61,0	48,0	65258	
0.5906	15,000 mm		16,0	133,0	83,0	60,0	48,0	65259	
0.6102	15,500 mm		16,0	133,0	83,0	60,0	48,0	65260	
0.6221	15,800 mm		16,0	133,0	83,0	59,0	48,0	65261	
0.6250	15,875 mm	5/8	16,0	133,0	83,0	59,0	48,0	55192	
0.6299	16,000 mm		16,0	133,0	83,0	59,0	48,0	65262	
0.6562	16,667 mm	21/32	18,0	143,0	93,0	68,0	48,0	55193	
0.6875	17,463 mm	11/16	18,0	143,0	93,0	67,0	48,0	55194	
0.7500	19,050 mm	3/4	20,0	153,0	101,0	72,0	50,0	55195	

TOLERANCES (inch)

- $\leq .1181$ DIAMETER**
DC = $+0.0008/+0.0047$
DCON = h_6
- $>.1181-.2362$ DIAMETER**
DC = $+0.0016/+0.0063$
DCON = h_6
- $>.2362-.3937$ DIAMETER**
DC = $+0.0024/+0.0083$
DCON = h_6
- $>.3937-.7087$ DIAMETER**
DC = $+0.0028/+0.0098$
DCON = h_6
- $>.7087-1.1811$ DIAMETER**
DC = $+0.0031/+0.0114$
DCON = h_6

TOLERANCES (mm)

- ≤ 3 DIAMETER**
DC = $+0,002/+0,012$
DCON = h_6
- $>3-6$ DIAMETER**
DC = $+0,004/+0,016$
DCON = h_6
- $>6-10$ DIAMETER**
DC = $+0,006/+0,021$
DCON = h_6
- $>10-18$ DIAMETER**
DC = $+0,007/+0,025$
DCON = h_6

CAST IRON

For patent information visit www.ksptpatents.com

Series 141K 5D Fractional	Hardness	Vc (sfm)		DC • in						
				1/8	3/16	1/4	3/8	1/2	5/8	3/4
GRAY CAST IRON FERRITIC ASTM A48: CLASS 20 SAE J431C: GRADE 1800	≤ 150 Bhn or ≤ 1 HRc	450 (360-540)	RPM	13752	9168	6876	4584	3438	2750	2292
			Fr	0.0049	0.0074	0.0099	0.0148	0.0198	0.0247	0.0297
			Feed (ipm)	68	68	68	68	68	68	68
GRAY CAST IRON PEARLITIC ASTM A48: CLASS 30, 35, 40 SAE J431C: GRADE 3000	≤ 220 Bhn or ≤ 19 HRc	375 (300-450)	RPM	11460	7640	5730	3820	2865	2292	1910
			Fr	0.0039	0.0059	0.0079	0.0118	0.0157	0.0196	0.0236
			Feed (ipm)	45	45	45	45	45	45	45
K COMPACTED GRAPHITE IRON	≤ 250 Bhn or ≤ 25 HRc	325 (260-390)	RPM	9932	6621	4966	3311	2483	1986	1655
			Fr	0.0039	0.0059	0.0079	0.0118	0.0157	0.0196	0.0236
			Feed (ipm)	39	39	39	39	39	39	39
MALLEABLE CAST IRON FERRITIC ASTM A220: GRADE 40010 SAE J158: GRADE M4504	≤ 160 Bhn or ≤ 3 HRc	450 (360-540)	RPM	13752	9168	6876	4584	3438	2750	2292
			Fr	0.0049	0.0074	0.0099	0.0148	0.0198	0.0247	0.0297
			Feed (ipm)	68	68	68	68	68	68	68
MALLEABLE CAST IRON MARTENSITE ASTM A220: GRADE 90001 SAE J158: GRADE M8501	≤ 320 Bhn or ≤ 34 HRc	250 (200-300)	RPM	7640	5093	3820	2547	1910	1528	1273
			Fr	0.0031	0.0047	0.0063	0.0094	0.0126	0.0157	0.0188
			Feed (ipm)	24	24	24	24	24	24	24

Bhn (Brinell) HRc (Rockwell C)
 $rpm = Vc \times 3.82 / DC$
 $ipm = Fr \times rpm$
 reduce speed and feed for materials harder than listed
 refer to the SGS Tool Wizard® for complete technical information (www.kyocera-sgstool.com)

Series 141K 5D Metric	Hardness	Vc (m/min)		DC • mm						
				3	6	8	10	12	14	16
GRAY CAST IRON FERRITIC ASTM A48: CLASS 20 SAE J431C: GRADE 1800	≤ 150 Bhn or ≤ 1 HRc	137 (110-165)	RPM	14541	7271	5453	4362	3635	3116	2726
			Fr	0.119	0.237	0.316	0.395	0.475	0.554	0.633
			Feed (mm/min)	1725	1725	1725	1725	1725	1725	1725
GRAY CAST IRON PEARLITIC ASTM A48: CLASS 30, 35, 40 SAE J431C: GRADE 3000	≤ 220 Bhn or ≤ 19 HRc	114 (91-137)	RPM	12118	6059	4544	3635	3029	2597	2272
			Fr	0.094	0.189	0.252	0.315	0.378	0.441	0.504
			Feed (mm/min)	1145	1145	1145	1145	1145	1145	1145
K COMPACTED GRAPHITE IRON	≤ 250 Bhn or ≤ 25 HRc	99 (79-119)	RPM	10502	5251	3938	3151	2626	2250	1969
			Fr	0.094	0.189	0.251	0.314	0.377	0.440	0.503
			Feed (mm/min)	990	990	990	990	990	990	990
MALLEABLE CAST IRON FERRITIC ASTM A220: GRADE 40010 SAE J158: GRADE M4504	≤ 160 Bhn or ≤ 3 HRc	137 (110-165)	RPM	14541	7271	5453	4362	3635	3116	2726
			Fr	0.119	0.237	0.316	0.395	0.475	0.554	0.633
			Feed (mm/min)	1725	1725	1725	1725	1725	1725	1725
MALLEABLE CAST IRON MARTENSITE ASTM A220: GRADE 90001 SAE J158: GRADE M8501	≤ 320 Bhn or ≤ 34 HRc	76 (61-91)	RPM	8078	4039	3029	2424	2020	1731	1515
			Fr	0.076	0.151	0.201	0.252	0.302	0.352	0.403
			Feed (mm/min)	610	610	610	610	610	610	610

(Brinell) HRc (Rockwell C)
 $rpm = (Vc \times 1000) / (DC \times 3.14)$
 $mm/min = Fr \times rpm$
 reduce speed and feed for materials harder than listed
 refer to the SGS Tool Wizard® for complete technical information (www.kyocera-sgstool.com)

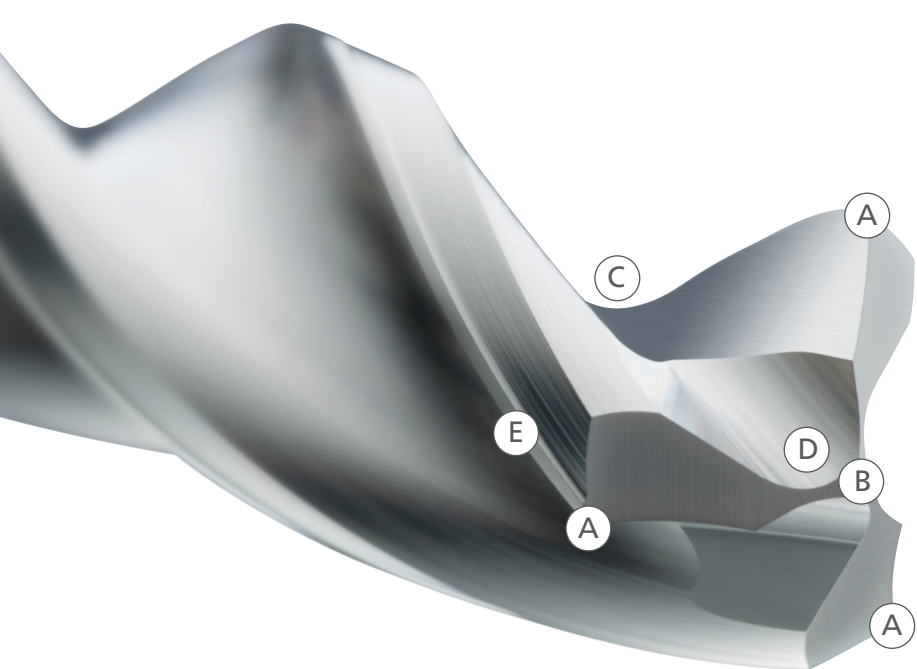

SERIES 131N



HIGH PERFORMANCE CARBIDE DRILLS

The key features designed into the Hi-PerCarb® Series 131N Drill allow the product to offer application benefits not only beyond that of standard carbide drills, but also other High Performance drills. Each feature of the Hi-PerCarb® Series 131N Drill was uniquely engineered as a solution towards addressing the issues commonly encountered during high production drilling.

- A** 3-MARGIN DESIGN
 - improved hole stability over two-flute designs
 - superior surface finish, roundness and hole cylindricity
 - unsurpassed hole size control
- B** SELF-STABILIZING POINT
 - pyramid design stabilizes the drill on contact with the workpiece
- C** OPEN FLUTE STRUCTURE
 - efficiently transports chips while maintaining strength at high feed rates
- D** SCULPTED GASH
 - allows chips to easily flow away from the drill center
 - reduced cutting forces over competitive three-flute designs
- E** MINIMAL MARGIN DESIGN
 - reduces frictional heat generated by excessive margin contact with the workpiece
 - parallel design maintains contact width as margin wears for performance consistency

PERFORMANCE. PRECISION. PASSION.
HI-PERCARB® SERIES 131N ALUMINUM DRILLS

PERFORMANCE.

FORCE COMPARISON

Series 131N drills with 15-20% less force than the top competitors

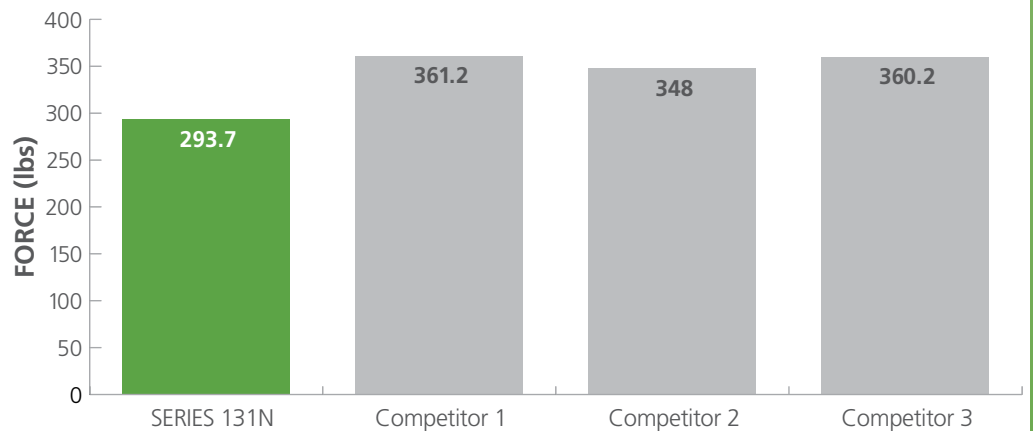

SURFACE FINISH COMPARISON

Series 131N drill results in improvement of hole finishes 30-60% over leading competitors

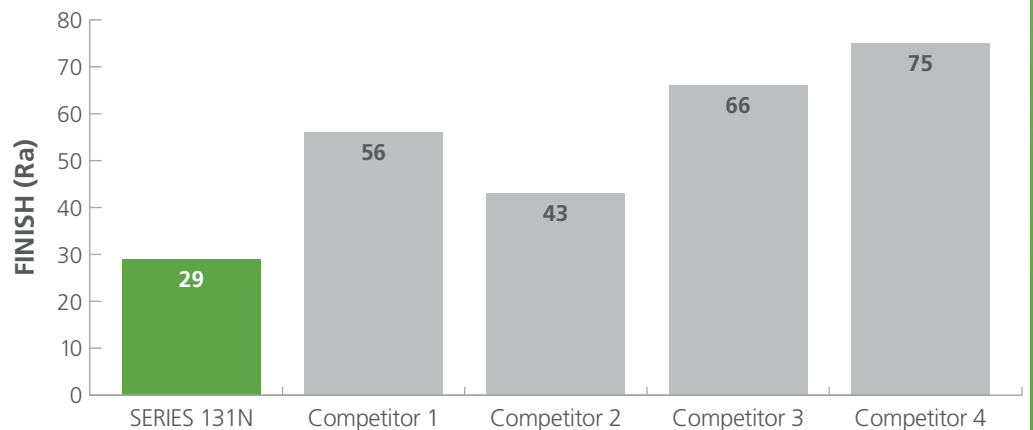

USAGE & WEAR COMPARISONS

Ti-NAMITE®-B coating significantly improves wear resistance, which is particularly beneficial when drilling high silicon aluminum alloys

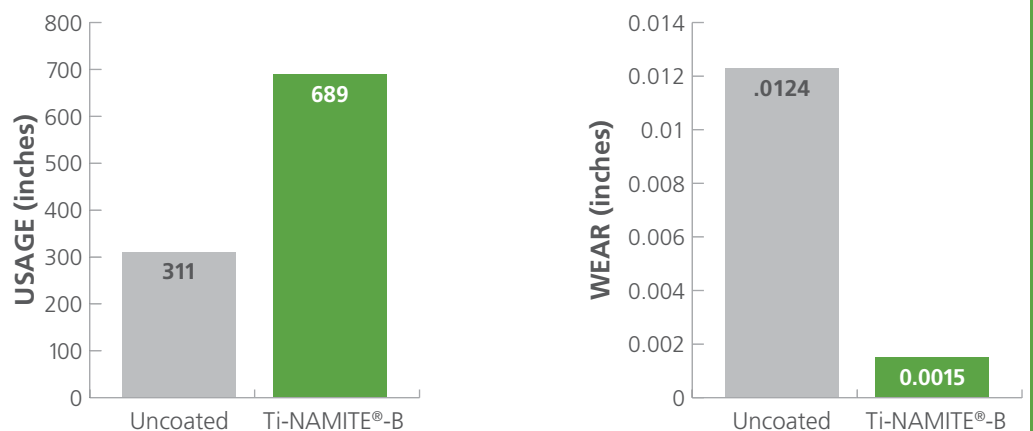

PRECISION.

SERIES 131N 3 Flute Drill vs. Competition 2 Flute Drill in 2024 Aluminum

4847 RPM
65 INCHES PER MINUTE

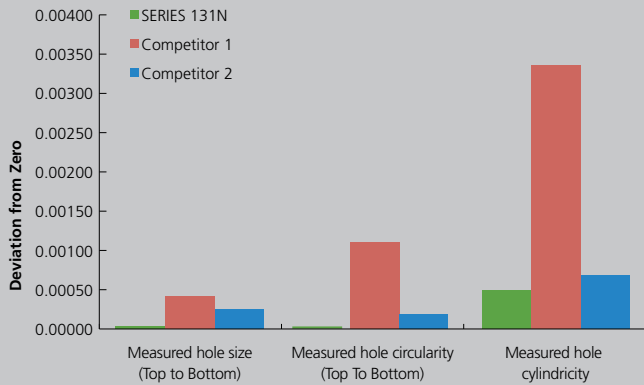

6786 RPM
100 INCHES PER MINUTE

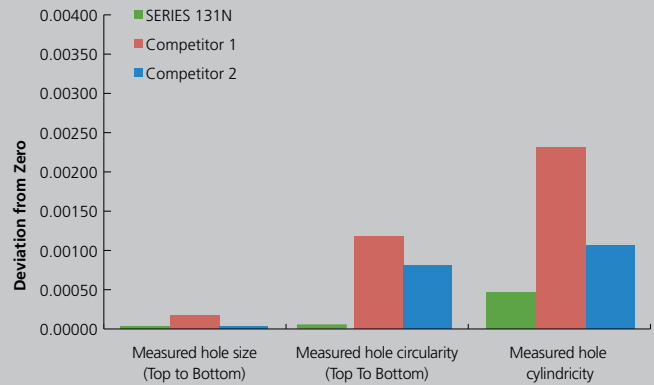

PASSION.

Lab Results Indicate the Hi-Per Carb® Series 131N Drill outperforms the competition in measured hole quality at a variety of speed and feed rates.



**9530 RPM
200 INCHES PER MINUTE**

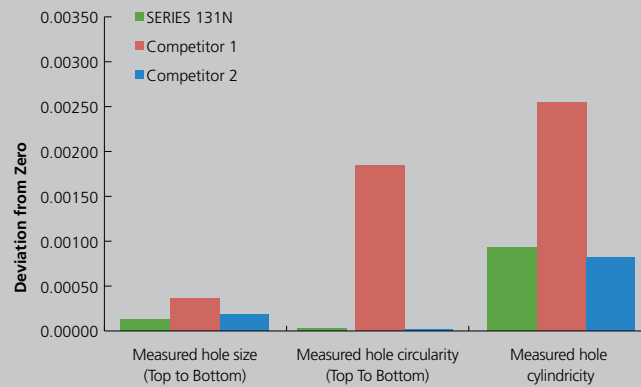

Ti-NAMITE®-B

This ceramic based coating ensures a smooth surface and a low affinity to cold welding or edge build-up, which makes it optimal for aluminum and copper applications. It has high toughness and high hardness.

Microhardness: 4000 HV

Oxidation Temperature: 850°C / 1562°F

Coefficient of Friction: 0.10–0.20

Thickness: 1–2 Microns (based on tool diameter)

FRACTIONAL & METRIC Series 131N



131N 3xD

FRACTIONAL & METRIC SERIES

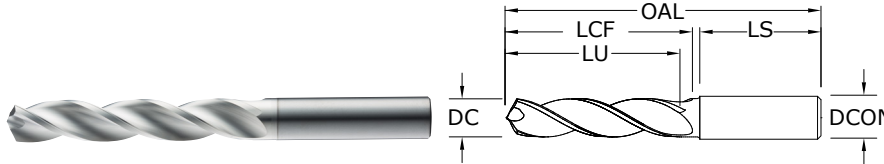

- 3-margin design improves hole stability and size control while providing superior finish, roundness and cylindricity
- Self-stabilizing pyramid point design stabilizes the drill on contact with the workpiece
- Open flute structure efficiently transports chips while maintaining strength at high feed rates
- Sculpted gash allows chips to easily flow away from the drill center
- Recommended for materials ≤ 175 Bhn (≤ 16 HRc)

DECIMAL DC	METRIC DC	FRACTIONAL/ LETTER/WIRE DC	inch & mm					EDP NO.	
			SHANK DIAMETER DCON	OVERALL LENGTH OAL	FLUTE LENGTH LCF	USABLE LENGTH LU	SHANK LENGTH LS	UNCOATED	Ti-NAMITE®-B (TiB ₂)
0.1181	3,000 mm		6,0	62,0	20,0	15,0	36,0	64600	67600
0.1220	3,100 mm		6,0	62,0	20,0	15,0	36,0	64601	67601
0.1250	3,175 mm	1/8	6,0	62,0	20,0	15,0	36,0	54600	54700
0.1260	3,200 mm		6,0	62,0	20,0	15,0	36,0	64602	67602
0.1299	3,300 mm		6,0	62,0	20,0	15,0	36,0	64603	67603
0.1339	3,400 mm		6,0	62,0	20,0	15,0	36,0	64604	67604
0.1360	3,454 mm	#29	6,0	62,0	20,0	15,0	36,0	54601	54701
0.1378	3,500 mm		6,0	62,0	20,0	15,0	36,0	64605	67605
0.1406	3,571 mm	9/64	6,0	62,0	20,0	15,0	36,0	54602	54702
0.1417	3,600 mm		6,0	62,0	20,0	15,0	36,0	64606	67606
0.1457	3,700 mm		6,0	62,0	20,0	15,0	36,0	64607	67607
0.1496	3,800 mm		6,0	66,0	24,0	18,0	36,0	64608	67608
0.1535	3,900 mm		6,0	66,0	24,0	18,0	36,0	64609	67609
0.1562	3,967 mm	5/32	6,0	66,0	24,0	18,0	36,0	54603	54703
0.1575	4,000 mm		6,0	66,0	24,0	18,0	36,0	64610	67610
0.1590	4,039 mm	#21	6,0	66,0	24,0	18,0	36,0	54604	54704
0.1614	4,100 mm		6,0	66,0	24,0	18,0	36,0	64611	67611
0.1654	4,200 mm		6,0	66,0	24,0	18,0	36,0	64612	67612
0.1693	4,300 mm		6,0	66,0	24,0	18,0	36,0	64613	67613
0.1719	4,366 mm	11/64	6,0	66,0	24,0	17,0	36,0	54605	54705
0.1732	4,400 mm		6,0	66,0	24,0	17,0	36,0	64614	67614
0.1772	4,500 mm		6,0	66,0	24,0	17,0	36,0	64615	67615
0.1811	4,600 mm		6,0	66,0	24,0	17,0	36,0	64616	67616
0.1850	4,699 mm	#13	6,0	66,0	24,0	17,0	36,0	64617	67617
0.1875	4,763 mm	3/16	6,0	66,0	28,0	21,0	36,0	54606	54706
0.1890	4,801 mm	#12	6,0	66,0	28,0	21,0	36,0	64618	67618
0.1929	4,900 mm		6,0	66,0	28,0	21,0	36,0	64619	67619
0.1969	5,000 mm		6,0	66,0	28,0	20,0	36,0	64620	67620
0.2008	5,100 mm		6,0	66,0	28,0	20,0	36,0	64621	67621
0.2031	5,159 mm	13/64	6,0	66,0	28,0	20,0	36,0	54607	54707
0.2047	5,200 mm		6,0	66,0	28,0	20,0	36,0	64622	67622
0.2087	5,300 mm		6,0	66,0	28,0	20,0	36,0	64623	67623
0.2126	5,400 mm		6,0	66,0	28,0	20,0	36,0	64624	67624
0.2165	5,500 mm		6,0	66,0	28,0	20,0	36,0	64625	67625
0.2188	5,558 mm	7/32	6,0	66,0	28,0	20,0	36,0	54608	54708
0.2205	5,600 mm		6,0	66,0	28,0	20,0	36,0	64626	67626
0.2244	5,700 mm		6,0	66,0	28,0	19,0	36,0	64627	67627
0.2283	5,800 mm		6,0	66,0	28,0	19,0	36,0	64628	67628

TOLERANCES (inch)

- ≤.1181 DIAMETER
DC = +.00008/+0.00047
DCON = h₆
- >.1181–.2362 DIAMETER
DC = +.00016/+0.00063
DCON = h₆
- >.2362–.3937 DIAMETER
DC = +.00024/+0.00083
DCON = h₆
- >.3937–.7087 DIAMETER
DC = +.00028/+0.00098
DCON = h₆
- >.7087–1.1811 DIAMETER
DC = +.00031/+0.00114
DCON = h₆

TOLERANCES (mm)

- ≤3 DIAMETER
DC = +0,002/+0,012
DCON = h₆
- >3–6 DIAMETER
DC = +0,004/+0,016
DCON = h₆
- >6–10 DIAMETER
DC = +0,006/+0,021
DCON = h₆
- >10–18 DIAMETER
DC = +0,007/+0,025
DCON = h₆

NON-FERROUS

For patent information visit www.ksptpatents.com

continued on next page



FRACTIONAL & METRIC Series 131N

131N 3xD

FRACTIONAL & METRIC SERIES

DECIMAL DC	METRIC DC	FRACTIONAL/ LETTER/WIRE DC	inch & mm					EDP NO.	
			SHANK DIAMETER DCON	OVERALL LENGTH OAL	FLUTE LENGTH LCF	USABLE LENGTH LU	SHANK LENGTH LS	UNCOATED	TI-NAMITE®-B (TiB ₂)
0.2323	5,900 mm		6,0	66,0	28,0	19,0	36,0	64629	67629
0.2344	5,954 mm	15/64	6,0	66,0	28,0	19,0	36,0	54609	54709
0.2362	6,000 mm		6,0	66,0	28,0	19,0	36,0	64630	67630
0.2402	6,100 mm		8,0	79,0	34,0	25,0	36,0	64631	67631
0.2441	6,200 mm		8,0	79,0	34,0	25,0	36,0	64632	67632
0.2480	6,300 mm		8,0	79,0	34,0	25,0	36,0	64633	67633
0.2500	6,350 mm	1/4 E #0	8,0	79,0	34,0	24,0	36,0	54610	54710
0.2520	6,400 mm		8,0	79,0	34,0	24,0	36,0	64634	67634
0.2559	6,500 mm		8,0	79,0	34,0	24,0	36,0	64635	67635
0.2570	6,528 mm	F	8,0	79,0	34,0	24,0	36,0	54611	54711
0.2598	6,600 mm		8,0	79,0	34,0	24,0	36,0	64636	67636
0.2638	6,700 mm		8,0	79,0	34,0	24,0	36,0	64637	67637
0.2656	6,746 mm	17/64	8,0	79,0	34,0	24,0	36,0	54612	54712
0.2677	6,800 mm		8,0	79,0	34,0	24,0	36,0	64638	67638
0.2717	6,900 mm		8,0	79,0	34,0	24,0	36,0	64639	67639
0.2756	7,000 mm		8,0	79,0	34,0	24,0	36,0	64640	67640
0.2795	7,100 mm		8,0	79,0	41,0	30,0	36,0	64641	67641
0.2812	7,142 mm	9/32	8,0	79,0	41,0	30,0	36,0	54613	54713
0.2835	7,200 mm		8,0	79,0	41,0	30,0	36,0	64642	67642
0.2874	7,300 mm		8,0	79,0	41,0	30,0	36,0	64643	67643
0.2913	7,400 mm		8,0	79,0	41,0	30,0	36,0	64644	67644
0.2953	7,500 mm		8,0	79,0	41,0	30,0	36,0	64645	67645
0.2969	7,541 mm	19/64	8,0	79,0	41,0	30,0	36,0	54614	54714
0.2992	7,600 mm		8,0	79,0	41,0	30,0	36,0	64646	67646
0.3031	7,700 mm		8,0	79,0	41,0	29,0	36,0	64647	67647
0.3071	7,800 mm		8,0	79,0	41,0	29,0	36,0	64648	67648
0.3110	7,900 mm		8,0	79,0	41,0	29,0	36,0	64649	67649
0.3125	7,938 mm	5/16	8,0	79,0	41,0	29,0	36,0	54615	54715
0.3150	8,000 mm		8,0	79,0	41,0	29,0	36,0	64650	67650
0.3189	8,100 mm		10,0	89,0	47,0	35,0	40,0	64651	67651
0.3228	8,200 mm		10,0	89,0	47,0	35,0	40,0	64652	67652
0.3268	8,300 mm		10,0	89,0	47,0	35,0	40,0	64653	67653
0.3281	8,334 mm	21/64	10,0	89,0	47,0	34,0	40,0	54616	54716
0.3307	8,400 mm		10,0	89,0	47,0	34,0	40,0	64654	67654
0.3320	8,433 mm	Q	10,0	89,0	47,0	34,0	40,0	54617	54717
0.3346	8,500 mm		10,0	89,0	47,0	34,0	40,0	64655	67655
0.3386	8,600 mm		10,0	89,0	47,0	34,0	40,0	64656	67656
0.3425	8,700 mm		10,0	89,0	47,0	34,0	40,0	64657	67657
0.3438	8,733 mm	11/32	10,0	89,0	47,0	34,0	40,0	54618	54718
0.3465	8,800 mm		10,0	89,0	47,0	34,0	40,0	64658	67658
0.3504	8,900 mm		10,0	89,0	47,0	34,0	40,0	64659	67659
0.3543	9,000 mm		10,0	89,0	47,0	34,0	40,0	64660	67660
0.3583	9,100 mm		10,0	89,0	47,0	33,0	40,0	64661	67661
0.3594	9,129 mm	23/64	10,0	89,0	47,0	33,0	40,0	54619	54719

continued on next page

CONTINUED

Series 131N 3xD | Fractional & Metric

FRACTIONAL & METRIC Series 131N



131N 3xD FRACTIONAL & METRIC SERIES

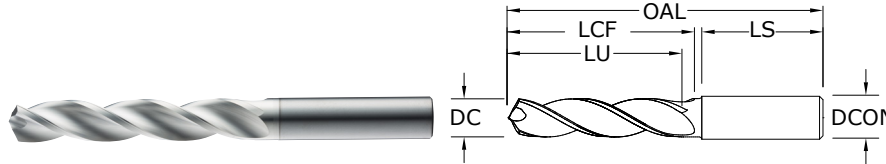

- 3-margin design improves hole stability and size control while providing superior finish, roundness and cylindricity
- Self-stabilizing pyramid point design stabilizes the drill on contact with the workpiece
- Open flute structure efficiently transports chips while maintaining strength at high feed rates
- Sculpted gash allows chips to easily flow away from the drill center
- Recommended for materials ≤ 175 Bhn (≤ 16 HRc)

DECIMAL DC	METRIC DC	FRACTIONAL/ LETTER/WIRE DC	inch & mm					EDP NO.	
			SHANK DIAMETER DCON	OVERALL LENGTH OAL	FLUTE LENGTH LCF	USABLE LENGTH LU	SHANK LENGTH LS	UNCOATED	Ti-NAMITE®-B (TiB ₂)
0.3622	9,200 mm		10,0	89,0	47,0	33,0	40,0	64662	67662
0.3661	9,300 mm		10,0	89,0	47,0	33,0	40,0	64663	67663
0.3680	9,347 mm	U	10,0	89,0	47,0	33,0	40,0	54620	54720
0.3701	9,400 mm		10,0	89,0	47,0	33,0	40,0	64664	67664
0.3740	9,500 mm		10,0	89,0	47,0	33,0	40,0	64665	67665
0.3750	9,525 mm	3/8	10,0	89,0	47,0	33,0	40,0	54621	54721
0.3780	9,600 mm		10,0	89,0	47,0	33,0	40,0	64666	67666
0.3819	9,700 mm		10,0	89,0	47,0	32,0	40,0	64667	67667
0.3858	9,800 mm		10,0	89,0	47,0	32,0	40,0	64668	67668
0.3898	9,900 mm		10,0	89,0	47,0	32,0	40,0	64669	67669
0.3906	9,921 mm	25/64	10,0	89,0	47,0	32,0	40,0	54622	54722
0.3937	10,000 mm		10,0	89,0	47,0	32,0	40,0	64670	67670
0.3976	10,100 mm		12,0	102,0	55,0	40,0	45,0	64671	67671
0.4016	10,200 mm		12,0	102,0	55,0	40,0	45,0	64672	67672
0.4055	10,300 mm		12,0	102,0	55,0	40,0	45,0	64673	67673
0.4062	10,317 mm	13/32	12,0	102,0	55,0	40,0	45,0	54623	54723
0.4095	10,400 mm		12,0	102,0	55,0	39,0	45,0	64674	67674
0.4134	10,500 mm		12,0	102,0	55,0	39,0	45,0	64675	67675
0.4173	10,600 mm		12,0	102,0	55,0	39,0	45,0	64676	67676
0.4213	10,700 mm		12,0	102,0	55,0	39,0	45,0	64677	67677
0.4219	10,716 mm	27/64	12,0	102,0	55,0	39,0	45,0	54624	54724
0.4252	10,800 mm		12,0	102,0	55,0	39,0	45,0	64678	67678
0.4291	10,900 mm		12,0	102,0	55,0	39,0	45,0	64679	67679
0.4331	11,000 mm		12,0	102,0	55,0	39,0	45,0	64680	67680
0.4370	11,100 mm		12,0	102,0	55,0	38,0	45,0	64681	67681
0.4375	11,113 mm	7/16	12,0	102,0	55,0	38,0	45,0	54625	54725
0.4409	11,200 mm		12,0	102,0	55,0	38,0	45,0	64682	67682
0.4449	11,300 mm		12,0	102,0	55,0	38,0	45,0	64683	67683
0.4488	11,400 mm		12,0	102,0	55,0	38,0	45,0	64684	67684
0.4528	11,500 mm		12,0	102,0	55,0	38,0	45,0	64685	67685
0.4567	11,600 mm		12,0	102,0	55,0	38,0	45,0	64686	67686
0.4606	11,700 mm		12,0	102,0	55,0	37,0	45,0	64687	67687
0.4646	11,800 mm		12,0	102,0	55,0	37,0	45,0	64688	67688
0.4685	11,900 mm		12,0	102,0	55,0	37,0	45,0	64689	67689
0.4688	11,908 mm	15/32	12,0	102,0	55,0	37,0	45,0	54626	54726
0.4724	12,000 mm		12,0	102,0	55,0	37,0	45,0	64690	67690
0.4844	12,304 mm	31/64	14,0	107,0	60,0	41,0	45,0	54627	54727
0.4921	12,500 mm		14,0	107,0	60,0	41,0	45,0	64691	67691

TOLERANCES (inch)

- ≤.1181 DIAMETER
DC = +.00008/+0.00047
DCON = h₆
- >.1181-.2362 DIAMETER
DC = +.00016/+0.00063
DCON = h₆
- >.2362-.3937 DIAMETER
DC = +.00024/+0.00083
DCON = h₆
- >.3937-.7087 DIAMETER
DC = +.00028/+0.00098
DCON = h₆
- >.7087-1.1811 DIAMETER
DC = +.00031/+0.00114
DCON = h₆

TOLERANCES (mm)

- ≤3 DIAMETER
DC = +0,002/+0,012
DCON = h₆
- >3-6 DIAMETER
DC = +0,004/+0,016
DCON = h₆
- >6-10 DIAMETER
DC = +0,006/+0,021
DCON = h₆
- >10-18 DIAMETER
DC = +0,007/+0,025
DCON = h₆

NON-FERROUS

For patent information visit www.ksptpatents.com

continued on next page



FRACTIONAL & METRIC Series 131N

131N 3xD

FRACTIONAL & METRIC SERIES

DECIMAL DC	METRIC DC	inch & mm						EDP NO.	
		FRACTIONAL/ LETTER/WIRE DC	SHANK DIAMETER DCON	OVERALL LENGTH OAL	FLUTE LENGTH LCF	USABLE LENGTH LU	SHANK LENGTH LS	UNCOATED	Ti-NAMITE®-B (TiB ₂)
0.5000	12,700 mm	1/2	14,0	107,0	60,0	41,0	45,0	54628	54728
0.5039	12,800 mm		14,0	107,0	60,0	41,0	45,0	64692	67692
0.5118	13,000 mm		14,0	107,0	60,0	41,0	45,0	64693	67693
0.5156	13,096 mm	33/64	14,0	107,0	60,0	40,0	45,0	54629	54729
0.5315	13,500 mm		14,0	107,0	60,0	40,0	45,0	64694	67694
0.5433	13,800 mm		14,0	107,0	60,0	39,0	45,0	64695	67695
0.5512	14,000 mm		14,0	107,0	60,0	39,0	45,0	64696	67696
0.5625	14,288 mm	9/16	16,0	115,0	65,0	43,0	48,0	54630	54730
0.5709	14,500 mm		16,0	115,0	65,0	43,0	48,0	64697	67697
0.5781	14,684 mm	37/64	16,0	115,0	65,0	43,0	48,0	54631	54731
0.5827	14,800 mm		16,0	115,0	65,0	43,0	48,0	64698	67698
0.5906	15,000 mm		16,0	115,0	65,0	42,0	48,0	64699	67699
0.6102	15,500 mm		16,0	115,0	65,0	42,0	48,0	64700	67700
0.6221	15,800 mm		16,0	115,0	65,0	41,0	48,0	64701	67701
0.6250	15,875 mm	5/8	16,0	115,0	65,0	41,0	48,0	54632	54732
0.6299	16,000 mm		16,0	115,0	65,0	41,0	48,0	64702	67702
0.6562	16,667 mm	21/32	18,0	123,0	73,0	47,0	48,0	54633	54733
0.6875	17,463 mm	11/16	18,0	123,0	73,0	47,0	48,0	54634	54734
0.7500	19,050 mm	3/4	20,0	131,0	79,0	50,0	50,0	54635	54735

CONTINUED

Series 131N 3xD | Fractional & Metric

FRACTIONAL & METRIC Series 131N



131N 5xD FRACTIONAL & METRIC SERIES

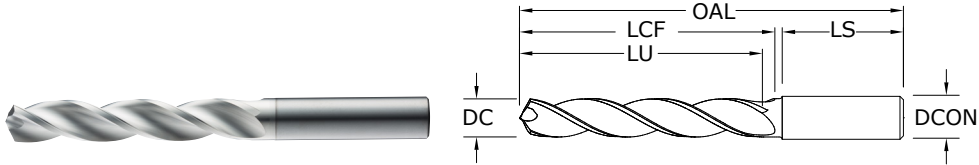

- 3-margin design improves hole stability and size control while providing superior finish, roundness and cylindricity
- Self-stabilizing pyramid point design stabilizes the drill on contact with the workpiece
- Open flute structure efficiently transports chips while maintaining strength at high feed rates
- Sculpted gash allows chips to easily flow away from the drill center
- Recommended for materials ≤ 175 Bhn (≤ 16 HRc)

DECIMAL DC	METRIC DC	inch & mm						EDP NO.	
		FRACTIONAL/ LETTER/WIRE DC	SHANK DIAMETER DCON	OVERALL LENGTH OAL	FLUTE LENGTH LCF	USABLE LENGTH LU	SHANK LENGTH LS	UNCOATED	TI-NAMITE®-B (TiB ₂)
0.1181	3,000 mm		6,0	66,0	28,0	23,0	36,0	65000	64800
0.1220	3,100 mm		6,0	66,0	28,0	23,0	36,0	65001	64801
0.1250	3,175 mm	1/8	6,0	66,0	28,0	23,0	36,0	55000	54800
0.1260	3,200 mm		6,0	66,0	28,0	23,0	36,0	65002	64802
0.1299	3,300 mm		6,0	66,0	28,0	23,0	36,0	65003	64803
0.1339	3,400 mm		6,0	66,0	28,0	23,0	36,0	65004	64804
0.1360	3,454 mm	#29	6,0	66,0	28,0	23,0	36,0	55001	54801
0.1378	3,500 mm		6,0	66,0	28,0	23,0	36,0	65005	64805
0.1406	3,571 mm	9/64	6,0	66,0	28,0	23,0	36,0	55002	54802
0.1417	3,600 mm		6,0	66,0	28,0	23,0	36,0	65006	64806
0.1457	3,700 mm		6,0	66,0	28,0	23,0	36,0	65007	64807
0.1496	3,800 mm		6,0	74,0	36,0	29,0	36,0	65008	64808
0.1535	3,900 mm		6,0	74,0	36,0	29,0	36,0	65009	64809
0.1562	3,967 mm	5/32	6,0	74,0	36,0	29,0	36,0	55003	54803
0.1575	4,000 mm		6,0	74,0	36,0	29,0	36,0	65010	64810
0.1590	4,039 mm	#21	6,0	74,0	36,0	29,0	36,0	55004	54804
0.1614	4,100 mm		6,0	74,0	36,0	29,0	36,0	65011	64811
0.1654	4,200 mm		6,0	74,0	36,0	29,0	36,0	65012	64812
0.1693	4,300 mm		6,0	74,0	36,0	29,0	36,0	65013	64813
0.1719	4,366 mm	11/64	6,0	74,0	36,0	29,0	36,0	55005	54805
0.1732	4,400 mm		6,0	74,0	36,0	29,0	36,0	65014	64814
0.1772	4,500 mm		6,0	74,0	36,0	29,0	36,0	65015	64815
0.1811	4,600 mm		6,0	74,0	36,0	29,0	36,0	65016	64816
0.1850	4,699 mm	#13	6,0	74,0	36,0	29,0	36,0	65017	64817
0.1875	4,763 mm	3/16	6,0	82,0	44,0	37,0	36,0	55006	54806
0.1890	4,801 mm	#12	6,0	82,0	44,0	37,0	36,0	65018	64818
0.1929	4,900 mm		6,0	82,0	44,0	37,0	36,0	65019	64819
0.1969	5,000 mm		6,0	82,0	44,0	36,0	36,0	65020	64820
0.2008	5,100 mm		6,0	82,0	44,0	36,0	36,0	65021	64821
0.2031	5,159 mm	13/64	6,0	82,0	44,0	36,0	36,0	55007	54807
0.2047	5,200 mm		6,0	82,0	44,0	36,0	36,0	65022	64822
0.2087	5,300 mm		6,0	82,0	44,0	36,0	36,0	65023	64823
0.2126	5,400 mm		6,0	82,0	44,0	36,0	36,0	65024	64824
0.2165	5,500 mm		6,0	82,0	44,0	36,0	36,0	65025	64825
0.2188	5,558 mm	7/32	6,0	82,0	44,0	36,0	36,0	55008	54808
0.2205	5,600 mm		6,0	82,0	44,0	36,0	36,0	65026	64826
0.2244	5,700 mm		6,0	82,0	44,0	35,0	36,0	65027	64827
0.2283	5,800 mm		6,0	82,0	44,0	35,0	36,0	65028	64828
0.2323	5,900 mm		6,0	82,0	44,0	35,0	36,0	65029	64829
0.2344	5,954 mm	15/64	6,0	82,0	44,0	35,0	36,0	55009	54809
0.2362	6,000 mm		6,0	82,0	44,0	35,0	36,0	65030	64830
0.2402	6,100 mm		8,0	91,0	53,0	44,0	36,0	65031	64831
0.2441	6,200 mm		8,0	91,0	53,0	44,0	36,0	65032	64832
0.2480	6,300 mm		8,0	91,0	53,0	44,0	36,0	65033	64833

TOLERANCES (inch)

- ≤.1181 DIAMETER**
DC = +.00008/+0.00047
DCON = h₆
- >.1181-.2362 DIAMETER**
DC = +.00016/+0.00063
DCON = h₆
- >.2362-.3937 DIAMETER**
DC = +.00024/+0.00083
DCON = h₆
- >.3937-.7087 DIAMETER**
DC = +.00028/+0.00098
DCON = h₆
- >.7087-1.1811 DIAMETER**
DC = +.00031/+0.00114
DCON = h₆

TOLERANCES (mm)

- ≤3 DIAMETER**
DC = +0,002/+0,012
DCON = h₆
- >3-6 DIAMETER**
DC = +0,004/+0,016
DCON = h₆
- >6-10 DIAMETER**
DC = +0,006/+0,021
DCON = h₆
- >10-18 DIAMETER**
DC = +0,007/+0,025
DCON = h₆

NON-FERROUS

For patent information visit www.ksptpatents.com

continued on next page



FRACTIONAL & METRIC Series 131N

131N 5xD

FRACTIONAL & METRIC SERIES

inch & mm								EDP NO.	
DECIMAL DC	METRIC DC	FRACTIONAL/ LETTER/WIRE DC	SHANK DIAMETER DCON	OVERALL LENGTH OAL	FLUTE LENGTH LCF	USABLE LENGTH LU	SHANK LENGTH LS	UNCOATED	TI-NAMITE®-B (TiB ₂)
0.2500	6,350 mm	1/4 E #0	8,0	91,0	53,0	43,0	36,0	55010	54810
0.2520	6,400 mm		8,0	91,0	53,0	43,0	36,0	65034	64834
0.2559	6,500 mm		8,0	91,0	53,0	43,0	36,0	65035	64835
0.2570	6,528 mm	F	8,0	91,0	53,0	43,0	36,0	55011	54811
0.2598	6,600 mm		8,0	91,0	53,0	43,0	36,0	65036	64836
0.2638	6,700 mm		8,0	91,0	53,0	43,0	36,0	65037	64837
0.2656	6,746 mm	17/64	8,0	91,0	53,0	43,0	36,0	55012	54812
0.2677	6,800 mm		8,0	91,0	53,0	43,0	36,0	65038	64838
0.2717	6,900 mm		8,0	91,0	53,0	43,0	36,0	65039	64839
0.2756	7,000 mm		8,0	91,0	53,0	42,0	36,0	65040	64840
0.2795	7,100 mm		8,0	91,0	53,0	42,0	36,0	65041	64841
0.2812	7,142 mm	9/32	8,0	91,0	53,0	42,0	36,0	55013	54813
0.2835	7,200 mm		8,0	91,0	53,0	42,0	36,0	65042	64842
0.2874	7,300 mm		8,0	91,0	53,0	42,0	36,0	65043	64843
0.2913	7,400 mm		8,0	91,0	53,0	42,0	36,0	65044	64844
0.2953	7,500 mm		8,0	91,0	53,0	42,0	36,0	65045	64845
0.2969	7,541 mm	19/64	8,0	91,0	53,0	42,0	36,0	55014	54814
0.2992	7,600 mm		8,0	91,0	53,0	42,0	36,0	65046	64846
0.3031	7,700 mm		8,0	91,0	53,0	41,0	36,0	65047	64847
0.3071	7,800 mm		8,0	91,0	53,0	41,0	36,0	65048	64848
0.3110	7,900 mm		8,0	91,0	53,0	41,0	36,0	65049	64849
0.3125	7,938 mm	5/16	8,0	91,0	53,0	41,0	36,0	55015	54815
0.3150	8,000 mm		8,0	91,0	53,0	41,0	36,0	65050	64850
0.3189	8,100 mm		10,0	103,0	61,0	49,0	40,0	65051	64851
0.3228	8,200 mm		10,0	103,0	61,0	49,0	40,0	65052	64852
0.3268	8,300 mm		10,0	103,0	61,0	49,0	40,0	65053	64853
0.3281	8,334 mm	21/64	10,0	103,0	61,0	48,0	40,0	55016	54816
0.3307	8,400 mm		10,0	103,0	61,0	48,0	40,0	65054	64854
0.3320	8,433 mm	Q	10,0	103,0	61,0	48,0	40,0	55017	54817
0.3346	8,500 mm		10,0	103,0	61,0	48,0	40,0	65055	64855
0.3386	8,600 mm		10,0	103,0	61,0	48,0	40,0	65056	64856
0.3425	8,700 mm		10,0	103,0	61,0	48,0	40,0	65057	64857
0.3438	8,733 mm	11/32	10,0	103,0	61,0	48,0	40,0	55018	54818
0.3465	8,800 mm		10,0	103,0	61,0	48,0	40,0	65058	64858
0.3504	8,900 mm		10,0	103,0	61,0	48,0	40,0	65059	64859
0.3543	9,000 mm		10,0	103,0	61,0	48,0	40,0	65060	64860
0.3583	9,100 mm		10,0	103,0	61,0	47,0	40,0	65061	64861
0.3594	9,129 mm	23/64	10,0	103,0	61,0	47,0	40,0	55019	54819
0.3622	9,200 mm		10,0	103,0	61,0	47,0	40,0	65062	64862
0.3661	9,300 mm		10,0	103,0	61,0	47,0	40,0	65063	64863
0.3680	9,347 mm	U	10,0	103,0	61,0	47,0	40,0	55020	54820
0.3701	9,400 mm		10,0	103,0	61,0	47,0	40,0	65064	64864
0.3740	9,500 mm		10,0	103,0	61,0	47,0	40,0	65065	64865
0.3750	9,525 mm	3/8	10,0	103,0	61,0	47,0	40,0	55021	54821
0.3780	9,600 mm		10,0	103,0	61,0	47,0	40,0	65066	64866
0.3819	9,700 mm		10,0	103,0	61,0	46,0	40,0	65067	64867
0.3858	9,800 mm		10,0	103,0	61,0	46,0	40,0	65068	64868
0.3898	9,900 mm		10,0	103,0	61,0	46,0	40,0	65069	64869
0.3906	9,921 mm	25/64	10,0	103,0	61,0	46,0	40,0	55022	54822
0.3937	10,000 mm		10,0	103,0	61,0	46,0	40,0	65070	64870
0.3976	10,100 mm		12,0	118,0	71,0	56,0	45,0	65071	64871
0.4016	10,200 mm		12,0	118,0	71,0	56,0	45,0	65072	64872

continued on next page

CONTINUED

Series 131N 5xD | Fractional & Metric

FRACTIONAL & METRIC Series 131N



131N 5xD FRACTIONAL & METRIC SERIES

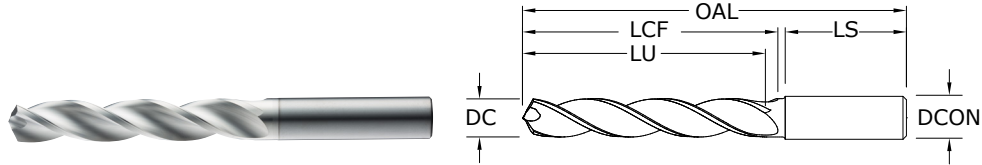

- 3-margin design improves hole stability and size control while providing superior finish, roundness and cylindricity
- Self-stabilizing pyramid point design stabilizes the drill on contact with the workpiece
- Open flute structure efficiently transports chips while maintaining strength at high feed rates
- Sculpted gash allows chips to easily flow away from the drill center
- Recommended for materials ≤ 175 Bhn (≤ 16 HRc)

DECIMAL DC	METRIC DC	inch & mm						EDP NO.	
		FRACTIONAL/ LETTER/WIRE DC	SHANK DIAMETER DCON	OVERALL LENGTH OAL	FLUTE LENGTH LCF	USABLE LENGTH LU	SHANK LENGTH LS	UNCOATED	TI-NAMITE®-B (TiB ₂)
0.4055	10,300 mm		12,0	118,0	71,0	56,0	45,0	65073	64873
0.4062	10,317 mm	13/32	12,0	118,0	71,0	56,0	45,0	55023	54823
0.4095	10,400 mm		12,0	118,0	71,0	55,0	45,0	65074	64874
0.4134	10,500 mm		12,0	118,0	71,0	55,0	45,0	65075	64875
0.4173	10,600 mm		12,0	118,0	71,0	55,0	45,0	65076	64876
0.4213	10,700 mm		12,0	118,0	71,0	55,0	45,0	65077	64877
0.4219	10,716 mm	27/64	12,0	118,0	71,0	55,0	45,0	55024	54824
0.4252	10,800 mm		12,0	118,0	71,0	55,0	45,0	65078	64878
0.4291	10,900 mm		12,0	118,0	71,0	55,0	45,0	65079	64879
0.4331	11,000 mm		12,0	118,0	71,0	54,0	45,0	65080	64880
0.4370	11,100 mm		12,0	118,0	71,0	54,0	45,0	65081	64881
0.4375	11,113 mm	7/16	12,0	118,0	71,0	54,0	45,0	55025	54825
0.4409	11,200 mm		12,0	118,0	71,0	54,0	45,0	65082	64882
0.4449	11,300 mm		12,0	118,0	71,0	54,0	45,0	65083	64883
0.4488	11,400 mm		12,0	118,0	71,0	54,0	45,0	65084	64884
0.4528	11,500 mm		12,0	118,0	71,0	54,0	45,0	65085	64885
0.4567	11,600 mm		12,0	118,0	71,0	54,0	45,0	65086	64886
0.4606	11,700 mm		12,0	118,0	71,0	53,0	45,0	65087	64887
0.4646	11,800 mm		12,0	118,0	71,0	53,0	45,0	65088	64888
0.4685	11,900 mm		12,0	118,0	71,0	53,0	45,0	65089	64889
0.4688	11,908 mm	15/32	12,0	118,0	71,0	53,0	45,0	55026	54826
0.4724	12,000 mm		12,0	118,0	71,0	53,0	45,0	65090	64890
0.4844	12,304 mm	31/64	14,0	124,0	77,0	58,0	45,0	55027	54827
0.4921	12,500 mm		14,0	124,0	77,0	58,0	45,0	65091	64891
0.5000	12,700 mm	1/2	14,0	124,0	77,0	58,0	45,0	55028	54828
0.5039	12,800 mm		14,0	124,0	77,0	58,0	45,0	65092	64892
0.5118	13,000 mm		14,0	124,0	77,0	58,0	45,0	65093	64893
0.5156	13,096 mm	33/64	14,0	124,0	77,0	57,0	45,0	55029	54829
0.5315	13,500 mm		14,0	124,0	77,0	57,0	45,0	65094	64894
0.5433	13,800 mm		14,0	124,0	77,0	56,0	45,0	65095	64895
0.5512	14,000 mm		14,0	124,0	77,0	56,0	45,0	65096	64896
0.5625	14,288 mm	9/16	16,0	133,0	83,0	61,0	48,0	55030	54830
0.5709	14,500 mm		16,0	133,0	83,0	61,0	48,0	65097	64897
0.5781	14,684 mm	37/64	16,0	133,0	83,0	61,0	48,0	55031	54831
0.5827	14,800 mm		16,0	133,0	83,0	61,0	48,0	65098	64898
0.5906	15,000 mm		16,0	133,0	83,0	60,0	48,0	65099	64899
0.6102	15,500 mm		16,0	133,0	83,0	60,0	48,0	65100	64900
0.6221	15,800 mm		16,0	133,0	83,0	59,0	48,0	65101	64901
0.6250	15,875 mm	5/8	16,0	133,0	83,0	59,0	48,0	55032	54832
0.6299	16,000 mm		16,0	133,0	83,0	59,0	48,0	65102	64902
0.6562	16,667 mm	21/32	18,0	143,0	93,0	68,0	48,0	55033	54833
0.6875	17,463 mm	11/16	18,0	143,0	93,0	67,0	48,0	55034	54834
0.7500	19,050 mm	3/4	20,0	153,0	101,0	72,0	50,0	55035	54835

TOLERANCES (inch)

- ≤.1181 DIAMETER**
DC = $+0.0008/+0.0047$
DCON = h_6
- >.1181-.2362 DIAMETER**
DC = $+0.0016/+0.0063$
DCON = h_6
- >.2362-.3937 DIAMETER**
DC = $+0.0024/+0.0083$
DCON = h_6
- >.3937-.7087 DIAMETER**
DC = $+0.0028/+0.0098$
DCON = h_6
- >.7087-1.1811 DIAMETER**
DC = $+0.0031/+0.0114$
DCON = h_6

TOLERANCES (mm)

- ≤3 DIAMETER**
DC = $+0,002/+0,012$
DCON = h_6
- >3-6 DIAMETER**
DC = $+0,004/+0,016$
DCON = h_6
- >6-10 DIAMETER**
DC = $+0,006/+0,021$
DCON = h_6
- >10-18 DIAMETER**
DC = $+0,007/+0,025$
DCON = h_6

NON-FERROUS

For patent information visit www.ksptpatents.com

Series 131N 3D & 5D Fractional	Hardness	Vc (sfm)	DC • in								
			1/8	3/16	1/4	3/8	1/2	5/8	3/4		
ALUMINUM ALLOYS < 12% SI 6061, 2024, 7075	≤ 150 Bhn or ≤ 88 HRb	800	RPM	24448	16299	12224	8149	6112	4890	4075	
		(640-960)	Fr	0.0055	0.0083	0.0110	0.0166	0.0221	0.0276	0.0331	
			Feed (ipm)	135	135	135	135	135	135	135	
	ALUMINUM ALLOYS > 12% SI A356.0, 390.0, 319.0	≤ 125 Bhn or ≤ 77 HRb	600	RPM	18336	12224	9168	6112	4584	3667	3056
			(480-720)	Fr	0.0055	0.0082	0.0109	0.0164	0.0218	0.0273	0.0327
				Feed (ipm)	100	100	100	100	100	100	100
COPPER ALLOYS Alum Bronze, Muntz Brass, Navel Brass	≤ 175 Bhn or ≤ 16 HRc	550	RPM	16808	11205	8404	5603	4202	3362	2801	
		(440-660)	Fr	0.0020	0.0030	0.0040	0.0061	0.0081	0.0101	0.0121	
			Feed (ipm)	34	34	34	34	34	34	34	
PLASTICS Acrylic, PVC, Polypropylene		450	RPM	13752	9168	6876	4584	3438	2750	2292	
		(360-540)	Fr	0.0025	0.0037	0.0049	0.0074	0.0099	0.0124	0.0148	
			Feed (ipm)	34	34	34	34	34	34	34	

Bhn (Brinell) HRc (Rockwell C) HRb (Rockwell B)
 rpm = Vc x 3.82 / DC
 ipm = Fr x rpm
 reduce speed and feed for materials harder than listed
 refer to the SGS Tool Wizard® for complete technical information (www.kyocera-sgstoool.com)

Series 131N 3D & 5D Metric	Hardness	Vc (m/min)	DC • mm								
			3	6	8	10	12	14	16		
ALUMINUM ALLOYS < 12% SI 6061, 2024, 7075	≤ 150 Bhn or ≤ 88 HRb	244	RPM	25851	12926	9694	7755	6463	5540	4847	
		(195-293)	Fr	0.133	0.265	0.354	0.442	0.531	0.619	0.708	
			Feed (mm/min)	3430	3430	3430	3430	3430	3430	3430	
	ALUMINUM ALLOYS > 12% SI A356.0, 390.0, 319.0	≤ 125 Bhn or ≤ 77 HRb	183	RPM	19388	9694	7271	5816	4847	4155	3635
			(146-219)	Fr	0.131	0.262	0.349	0.437	0.524	0.611	0.699
				Feed (mm/min)	2540	2540	2540	2540	2540	2540	2540
COPPER ALLOYS Alum Bronze, Muntz Brass, Navel Brass	≤ 175 Bhn or ≤ 16 HRc	168	RPM	17773	8886	6665	5332	4443	3808	3332	
		(134-201)	Fr	0.049	0.097	0.130	0.162	0.194	0.227	0.259	
			Feed (mm/min)	864	864	864	864	864	864	864	
PLASTICS Acrylic, PVC, Polypropylene		137	RPM	14541	7271	5453	4362	3635	3116	2726	
		(110-165)	Fr	0.059	0.119	0.158	0.198	0.238	0.277	0.317	
			Feed (mm/min)	864	864	864	864	864	864	864	

Bhn (Brinell) HRc (Rockwell C) HRb (Rockwell B)
 rpm = (Vc x 1000) / (DC x 3.14)
 mm/min = Fr x rpm
 reduce speed and feed for materials harder than listed
 refer to the SGS Tool Wizard® for complete technical information (www.kyocera-sgstoool.com)

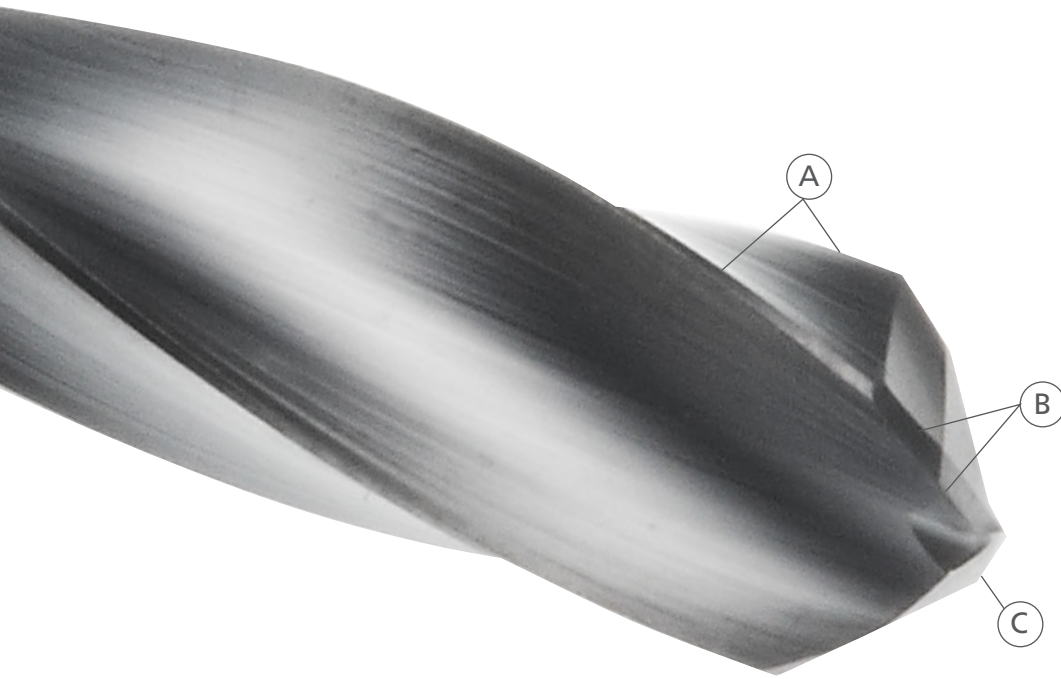

SERIES 120

SERIES 120 COMPOSITE DRILL

The key features of the 8 Facet Double Angle Series 120 drill design offers application benefits beyond that of other high performance drills in its category. Each feature of this 8 facet design was engineered as a solution towards addressing the issues commonly encountered during Composite drilling. This unique High Performance design successfully creates an accurate hole without splintering or delamination.

- A** 4-MARGIN CONSTRUCTION
 - improves drill stability for better hole finish and size control
 - allows coolant to reach the point for improved hole quality and extended tool life
- B** DOUBLE ANGLE POINT
 - minimizes workpiece delamination on drill entry and exit
 - redistributes loads along multiple cutting edges for improved performance
- C** NOTCHED POINT
 - reduces cutting forces at the drill center for enhanced performance and tool life
 - manufactured exclusively with Di-NAMITE® coating for even wear, extended tool life, and improved finishes

PERFORMANCE. PRECISION. PASSION.
SERIES 120 COMPOSITE DRILL

PERFORMANCE.





- 4-margin design stabilized the drill for greater hole accuracy and improved surface finish in final hole.
- Minimized delamination at hole entry/exit.
- Manufactured exclusively with Di-NAMITE® coating for even wear, extended tool life and improved finishes.



PRECISION.

A test was conducted of our CFRP drill to determine the necessity of coating when drilling Carbon Fiber material. Fifty holes were drilled using a special size .190" CFRP drill. The tool's design produces acceptable quality holes; but as shown in the photos, early edge wear on the uncoated drill resulted in holes with frayed edges. The diamond coated drill produced all 50 holes with little to no fraying and edge wear was 38% less than the uncoated drills.

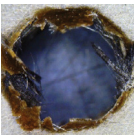
The geometry of the 8 Facet drill with the Di-NAMITE® coating is a necessity for additional tool life and productivity when manufacturing Carbon Fiber material.

SPEED 5,000 rpm	FEED 5.0 ipm	DIAMETER .190"	HOLE DEPTH .240"	WORKPIECE CFRP	MACHINE TYPE Vertical Machining Center	COOLANT none
---------------------------	------------------------	--------------------------	----------------------------	--------------------------	--	------------------------

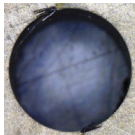
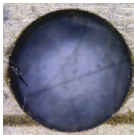
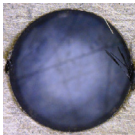
TOOL NO.	TYPE DESCRIPTION	TIR IN MACHINE	USAGE
1	.190" CFRP drill uncoated	.0001"	50 holes
INSPECTION NOTES		Good hole quality for 1st 3 holes. fraying starting by 3rd hole, .0021" wear	
1ST HOLE	3RD HOLE	50TH HOLE	AFTER 50 HOLES
			

TOOL NO.	TYPE DESCRIPTION	TIR IN MACHINE	USAGE
2	.190" CFRP drill diamond	.0002"	50 holes
INSPECTION NOTES		Good hole quality all 50 holes slight fraying, .0013" wear	
1ST HOLE	25TH HOLE	50TH HOLE	AFTER 50 HOLES
			



PASSION.

- The compound angle creates 4 cutting edges along the drill point.
- Distinct double angle prevents abrasiveness of the Composite from localizing along the point and diminishing tool life.

FRACTIONAL & METRIC Series 120

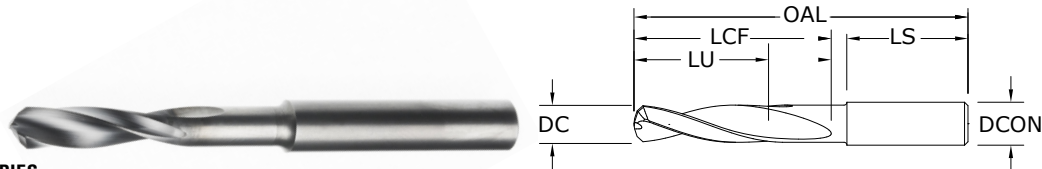

120

FRACTIONAL & METRIC SERIES

- 4-margin design stabilizes the drill for greater hole accuracy and improved surface finish
- Notched point reduces thrust force over conventional designs
- 8 facet point reduces fiber breakout and delamination on exit
- 90 degree secondary chamfer angle improves hole entrance and exit quality

DECIMAL DC	METRIC DC	FRACTIONAL/ LETTER/WIRE DC	inch & mm		FLUTE LENGTH LCF	USABLE LENGTH LU	SHANK LENGTH LS	EDP NO.
			SHANK DIAMETER DCON	OVERALL LENGTH OAL				
0.0980	2,489 mm	#40	1/8	2	9/16	7/16	1-1/4	50000
0.1063	2,700 mm		6,0	63,0	20,0	16,0	32,0	50001
0.1181	3,000 mm		6,0	63,0	20,0	16,0	36,0	50002
0.1250	3,175 mm	1/8	1/4	2-1/2	3/4	9/16	1-7/16	50003
0.1260	3,200 mm		6,0	63,0	20,0	15,0	36,0	50004
0.1285	3,264 mm	#30	1/4	2-1/2	3/4	9/16	1-7/16	50005
0.1405	3,569 mm	#28	1/4	2-1/2	3/4	9/16	1-7/16	50006
0.1570	3,988 mm	#22	1/4	2-5/8	7/8	5/8	1-7/16	50007
0.1590	4,039 mm	#21	1/4	2-5/8	7/8	5/8	1-7/16	50008
0.1614	4,100 mm		6,0	66,0	24,0	18,0	36,0	50009
0.1660	4,216 mm	#19	1/4	2-5/8	7/8	5/8	1-7/16	50010
0.1719	4,366 mm	11/64	1/4	2-5/8	7/8	5/8	1-7/16	50011
0.1875	4,763 mm	3/16	1/4	2-5/8	1	23/32	1-7/16	50012
0.1910	4,851 mm	#11	1/4	2-5/8	1	23/32	1-7/16	50013
0.1990	5,055 mm	#8	1/4	2-5/8	1	23/32	1-7/16	50014
0.2010	5,105 mm	#7	1/4	2-5/8	1	23/32	1-7/16	50015
0.2210	5,613 mm	#2	1/4	2-5/8	1	21/32	1-7/16	50016
0.2362	6,000 mm		6,0	66,0	28,0	19,0	36,0	50017
0.2500	6,350 mm	1/4 E #0	1/4	3-1/8	1-5/16	15/16	1-7/16	50018
0.2510	6,380 mm		5/16	3-1/8	1-5/16	15/16	1-7/16	50019
0.2570	6,528 mm	F	5/16	3-1/8	1-5/16	15/16	1-7/16	50020
0.2720	6,909 mm	I	5/16	3-1/8	1-5/16	29/32	1-7/16	50021
0.2770	7,036 mm	J	5/16	3-1/8	1-5/16	29/32	1-7/16	50022
0.2810	7,137 mm	K	5/16	3-1/8	1-9/16	1-9/64	1-7/16	50023
0.3125	7,938 mm	5/16	5/16	3-1/8	1-9/16	1-3/32	1-7/16	50024
0.3150	8,000 mm		8,0	79,0	41,0	29,0	36,0	50025
0.3750	9,525 mm	3/8	3/8	3-1/2	1-27/32	1-9/32	1-9/16	50026
0.3770	9,576 mm	V	1/2	3-1/2	1-27/32	1-9/32	1-9/16	50027
0.3937	10,000 mm		10,0	89,0	47,0	32,0	40,0	50028
0.4375	11,113 mm	7/16	1/2	4-1/16	2-3/16	1-17/32	1-9/16	50029
0.4724	12,000 mm		12,0	102,0	55,0	37,0	45,0	50030
0.5000	12,700 mm	1/2	1/2	4-1/4	2-5/16	1-9/16	1-3/4	50031

TOLERANCES (inch)

DC = +.0000/+0.0005

DCON = h₆

TOLERANCES (mm)

DC = +0,000/+0,013

DCON = h₆

NON-FERROUS

For patent information visit www.ksptpatents.com

Series 120 Fractional	Vc (sfm)		DC • in						
			1/8	3/16	1/4	5/16	3/8	7/16	1/2
N CFRP, AFRP (Carbon Fiber, Aramid Fiber)	320 (256-384)	RPM	9779	6519	4890	3912	3260	2794	2445
		Fr	0.0006	0.0009	0.0012	0.0015	0.0018	0.0021	0.0024
		Feed (ipm)	5.9	5.9	5.9	5.9	5.9	5.9	5.9
N GFRP (Fiberglass)	240 (192-288)	RPM	7334	4890	3667	2934	2445	2096	1834
		Fr	0.0006	0.0009	0.0012	0.0015	0.0018	0.0021	0.0024
		Feed (ipm)	4.4	4.4	4.4	4.4	4.4	4.4	4.4
N CARBON, GRAPHITE	400 (320-480)	RPM	12224	8149	6112	4890	4075	3493	3056
		Fr	0.0008	0.0012	0.0016	0.0020	0.0024	0.0028	0.0032
		Feed (ipm)	9.8	9.8	9.8	9.8	9.8	9.8	9.8

rpm = Vc x 3.82 / DC
 ipm = Fr x rpm
 adjust speed and / or feed based on resin type and / or fiber structure
 refer to the SGS Tool Wizard® for complete technical information (www.kyocera-sgstool.com)

Series 120 Metric	Vc (m/min)		DC • mm						
			2.5	3	4	6	8	10	12
N CFRP, AFRP (Carbon Fiber, Aramid Fiber)	100 (80-120)	RPM	12722	10602	7951	5301	3976	3181	2650
		Fr	0.012	0.014	0.019	0.028	0.038	0.047	0.057
		Feed (mm/min)	150	150	150	150	150	150	150
N GFRP (Fiberglass)	75 (65-90)	RPM	9542	7951	5963	3976	2982	2385	1988
		Fr	0.012	0.014	0.019	0.029	0.039	0.048	0.058
		Feed (mm/min)	115	115	115	115	115	115	115
N CARBON, GRAPHITE	120 (96-144)	RPM	15266	12722	9542	6361	4771	3817	3181
		Fr	0.015	0.018	0.025	0.037	0.049	0.062	0.074
		Feed (mm/min)	235	235	235	235	235	235	235

rpm = (Vc x 1000) / (DC x 3.14)
 mm/min = Fr x rpm
 adjust speed and / or feed based on resin type and / or fiber structure
 refer to the SGS Tool Wizard® for complete technical information (www.kyocera-sgstool.com)

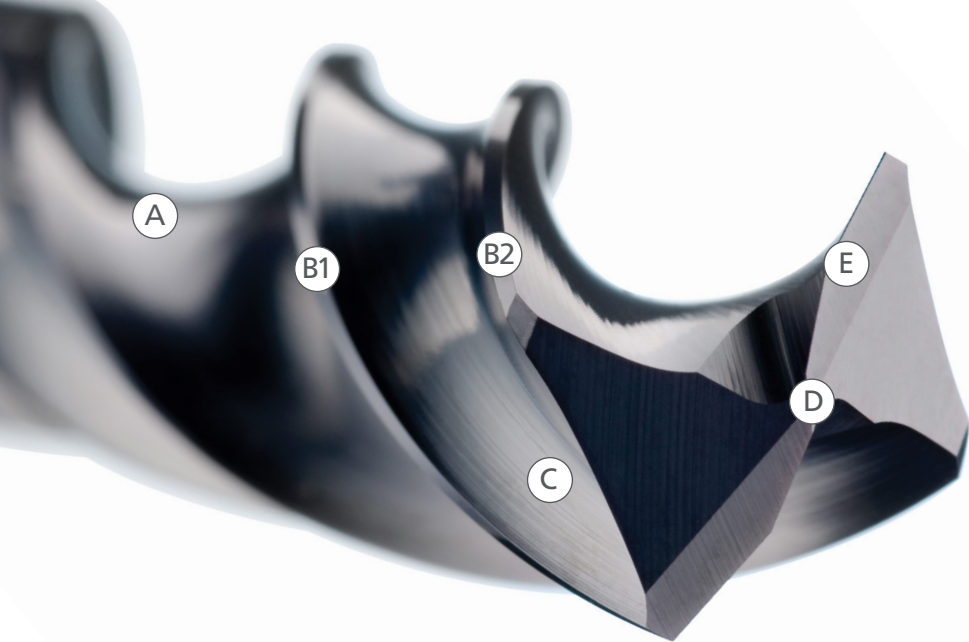

SERIES 135



HIGH PERFORMANCE CARBIDE DRILLS

The key features designed into the Hi-PerCarb® Series 135 Drill allow the product to offer application benefits not only beyond that of standard carbide drills, but also other High Performance drills. Each feature of the Hi-PerCarb® Series 135 Drill was uniquely engineered as a solution towards addressing the issues commonly encountered during high production drilling.

- (A) HIGH PERFORMANCE FLUTE DESIGN**
 - efficiently transports chips
 - increases strength for aggressive drilling

Ti-NAMITE®-A COATING
 - improves resistance to heat and wear
 - enhances tool life

- (B1) 4-MARGIN DESIGN**
 - improves accuracy and surface finish
- (B2) 4-MARGIN DESIGN**
 - increases stability and rigidity

- (C) SECONDARY FLUTE**
 - improves coolant flow to point
 - reduces friction along drill body
 - assists in fine swarf evacuation

- (D) SPECIALIZED 145° NOTCHED POINT**
 - self centering eliminates need for spot drill
 - improves chip control
 - decreases drill thrust and deflection

- (E) ENGINEERED EDGE PROTECTION**
 - improves edge strength
 - reduces edge fatigue
 - allows increased feed rates

PERFORMANCE. PRECISION. PASSION.
HI-PERCARB® SERIES 135 DRILLS

PERFORMANCE.

MACHINING ENVIRONMENT:

Haas VM-3 with 9% Water Soluble Oil Flood Coolant

5/16" (.3125) diameter hole:

4140 application – .650" deep

6Al-4V application – 1.125" deep

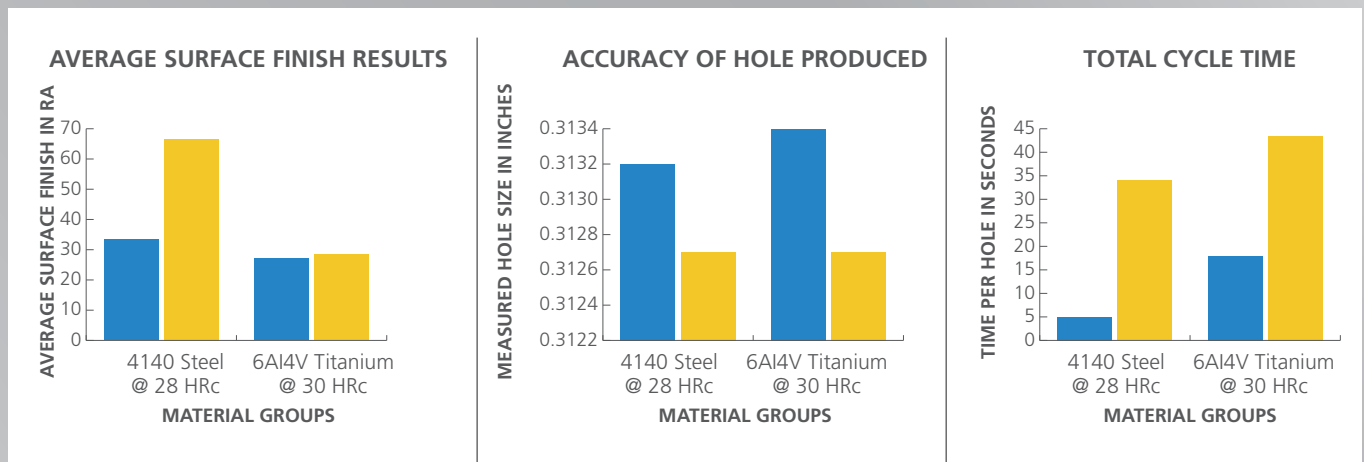

■ HI-PERCARB® SERIES 135 ■ SOLID CARBIDE DRILL AND REAMER

The 4-margin design gives the Hi-PerCarb® Series 135 Drill a burnishing effect and the flute form effectively controls and transports chips allowing the drill to offer superior surface finishes and hole size in high production environments saving cycle time by often avoiding the need for reaming in many applications.

PRECISION.

The stability of the 4-margin design and penetration capability of the point geometry allow the Hi-PerCarb® Series 135 Drill to address demanding applications that would normally require reduced operating parameters or a two step process.

PASSION.

The secondary flute provides a channel for cooling capabilities normally not found in external coolant drills, this combined with the Ti-NAMITE®-A tool coating and the high strength edge design results in increased operating parameters with additional tool life.

ACTUAL CUSTOMER APPLICATION USING A 6MM DRILL IN 17-4 PH STAINLESS STEEL

	COMPETITOR	HI-PERCARB® SERIES 135
NUMBER OF PARTS TO PRODUCE	50000	50000
SURFACE FEET PER MINUTE (SFM)	74	124
SPEED IN REVOLUTIONS PER MINUTE (RPM)	1200	2000
FEED IN INCHES PER MINUTE (IPM)	3.6	10
NUMBER OF PARTS PRODUCED PER TOOL	140	500
DEPTH OF HOLE	0.6800	0.6800
NUMBER OF NEW TOOLS REQUIRED TO COMPLETE JOB	358	100
TOTAL HOURS OF MACHINING TIME	157	57
TOTAL MACHINING COST	\$10,231.48	\$3,683.33
TOOL CHANGE COST	\$1,939.17	\$541.67
TOTAL COST	\$39,017.07	\$8,460.00
COST PER PART	\$0.78	\$0.17
MATERIAL REMOVAL RATE (IN ³ / MIN) – DRILLING	0.16	0.44
CUTTING TIME PER PART – MINUTES	0.19	0.07
SAVINGS PER PART – DOLLARS	0	\$0.61
TOTAL COST SAVINGS / JOB – PERCENTAGE	0	78.32%
TOTAL COST SAVINGS / JOB – DOLLARS	0	\$30,557.07

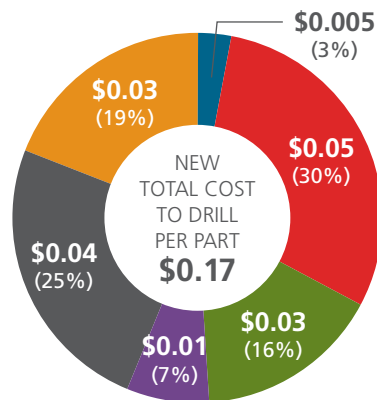
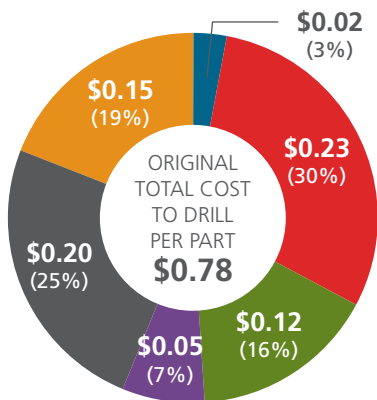
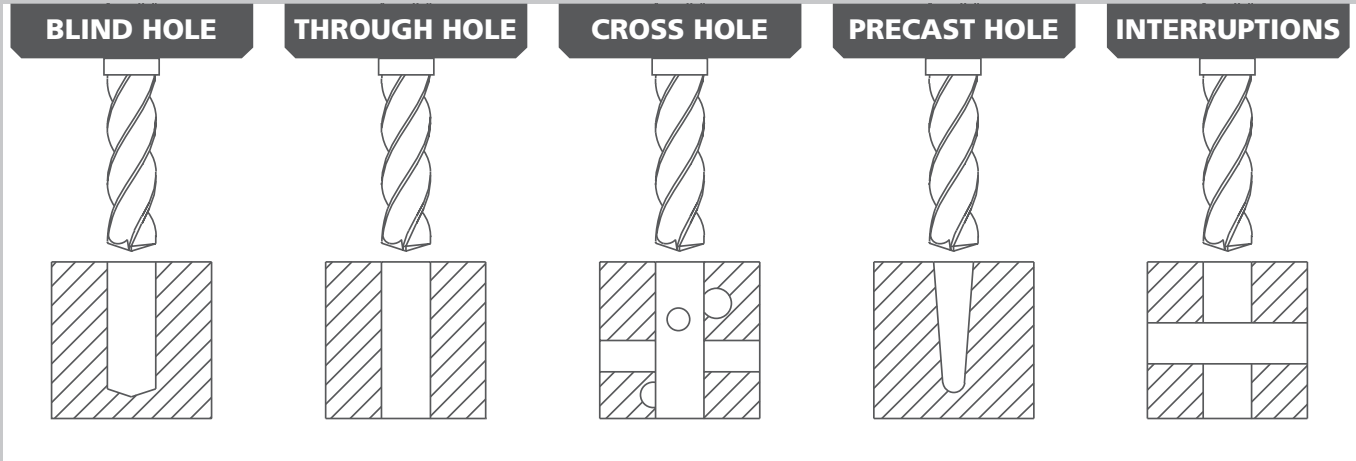

- TOOL COST
- MACHINING COST
- COOLANT COST
- MACHINE DOWNTIME COST
- TOOL CHANGE COST
- ADMINISTRATIVE COST

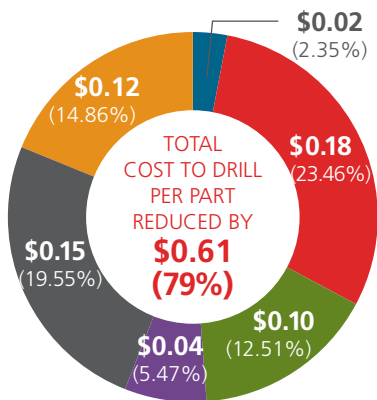

- TOOL COST REDUCED BY
- MACHINING COST REDUCED BY
- COOLANT COST REDUCED BY
- MACHINE DOWNTIME COST REDUCED BY
- TOOL CHANGE COST REDUCED BY
- ADMINISTRATIVE COST REDUCED BY

- Using 100 tools per job compared to 358 means less inventory and fewer purchase orders to issue resulting in improved administrative cost and reduced tooling cost per job.
- Increasing the feed by 278% has decreased the total hours of machine time by 100 hours gaining manufacturing capacity; this factored with the hourly shop rate has resulted in the largest portion of the savings.
- With a tool life of 500 parts compared to 140 parts or a 357% improvement in tool life equates to less time dedicated to changing tools to keep the job running.
- Increasing the material removal rate by .28 cubic inches or 275% requires less time in the cut and a reduced use of coolant.

FRACTIONAL & METRIC Series 135



135 3xD

FRACTIONAL & METRIC SERIES

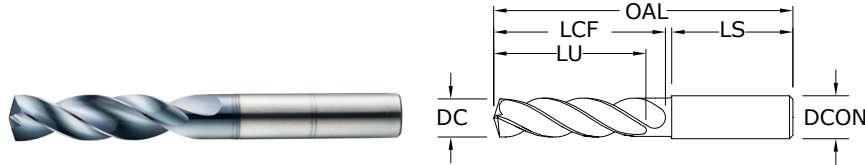

- 4-margin design improves accuracy and surface finish along with increased strength for aggressive drilling
- Specialized self-centering notched point eliminates the need for spot drilling decreasing thrust and deflection
- Engineered edge protection improves edge strength and reduces edge fatigue allowing for increased feed rates
- Recommended for materials ≤ 50 HRc (≤ 475 Bhn)

inch & mm								EDP NO.
DECIMAL DC	METRIC DC	FRACTIONAL/ LETTER/WIRE DC	SHANK DIAMETER DCON	OVERALL LENGTH OAL	FLUTE LENGTH LCF	USABLE LENGTH LU	SHANK LENGTH LS	Ti-NAMITE-A (AITIN)
0.0156	0,396 mm	1/64	1/8	1-1/2	1/8	7/64	1	51752*
0.0312	0,792 mm	1/32	1/8	1-1/2	1/4	13/64	1	51269*
0.0469	1,191 mm	3/64	1/8	1-1/2	3/8	5/16	1	51270*
0.0492	1,250 mm		3,0	38,0	9,5	8,0	25,0	64500*
0.0571	1,450 mm		3,0	38,0	9,5	7,0	25,0	64501*
0.0595	1,511 mm	#53	1/8	1-1/2	3/8	9/32	1	64502*
0.0625	1,588 mm	1/16	1/8	2	7/16	11/32	1-1/4	51271*
0.0630	1,600 mm		3,0	50,0	11,0	9,0	32,0	64503*
0.0689	1,750 mm		3,0	50,0	11,0	8,0	32,0	64504*
0.0700	1,778 mm	#50	1/8	2	7/16	21/64	1-1/4	64505*
0.0781	1,984 mm	5/64	1/8	2	1/2	25/64	1-1/4	51272*
0.0785	1,994 mm	#47	1/8	2	1/2	25/64	1-1/4	64506*
0.0807	2,050 mm		3,0	50,0	12,0	9,0	32,0	64507*
0.0810	2,057 mm	#46	1/8	2	1/2	3/8	1-1/4	64508*
0.0890	2,261 mm	#43	1/8	2	1/2	3/8	1-1/4	64509*
0.0935	2,375 mm	#42	1/8	2	1/2	23/64	1-1/4	64510*
0.0938	2,383 mm	3/32	1/8	2	1/2	23/64	1-1/4	51273
0.0980	2,489 mm	#40	1/8	2	9/16	27/64	1-1/4	51274
0.0984	2,500 mm		3,0	50,0	14,0	10,0	32,0	64511
0.0995	2,527 mm	#39	1/8	2	9/16	27/64	1-1/4	51753
0.1015	2,578 mm	#38	1/8	2	9/16	27/64	1-1/4	51754
0.1040	2,642 mm	#37	1/8	2	9/16	13/32	1-1/4	51755
0.1065	2,705 mm	#36	1/8	2	9/16	13/32	1-1/4	51756
0.1094	2,779 mm	7/64	1/8	2	5/8	15/32	1-1/4	51275
0.1100	2,794 mm	#35	1/8	2	5/8	15/32	1-1/4	51276
0.1110	2,819 mm	#34	1/8	2	5/8	15/32	1-1/4	51277
0.1130	2,870 mm	#33	1/8	2	5/8	29/64	1-1/4	51757
0.1142	2,900 mm		3,0	50,0	16,0	12,0	32,0	64512
0.1160	2,946 mm	#32	1/8	2	5/8	29/64	1-1/4	51758
0.1181	3,000 mm		6,0	62,0	20,0	16,0	36,0	63155
0.1200	3,048 mm	#31	1/8	2	5/8	29/64	1-1/4	51759
0.1220	3,100 mm		6,0	62,0	20,0	15,0	36,0	63741
0.1250	3,175 mm	1/8	1/4	2-1/2	3/4	9/16	1-7/16	51330
0.1260	3,200 mm		6,0	62,0	20,0	15,0	36,0	63156
0.1285	3,264 mm	#30	1/4	2-1/2	3/4	9/16	1-7/16	51278
0.1299	3,300 mm		6,0	62,0	20,0	15,0	36,0	63157
0.1339	3,400 mm		6,0	62,0	20,0	15,0	36,0	63158
0.1360	3,454 mm	#29	1/4	2-1/2	3/4	9/16	1-7/16	51331

*Single Margin

continued on next page

TOLERANCES (inch)

$\leq .1181$ DIAMETER

DC = $+0.0008/+0.0047$
DCON = h_6

$>.1181-.2362$ DIAMETER

DC = $+0.0016/+0.0063$
DCON = h_6

$>.2362-.3937$ DIAMETER

DC = $+0.0024/+0.0083$
DCON = h_6

$>.3937-.7087$ DIAMETER

DC = $+0.0028/+0.0098$
DCON = h_6

$>.7087-1.1811$ DIAMETER

DC = $+0.0031/+0.0114$
DCON = h_6

TOLERANCES (mm)

≤ 3 DIAMETER

DC = $+0,002/+0,012$
DCON = h_6

$>3-6$ DIAMETER

DC = $+0,004/+0,016$
DCON = h_6

$>6-10$ DIAMETER

DC = $+0,006/+0,021$
DCON = h_6

$>10-18$ DIAMETER

DC = $+0,007/+0,025$
DCON = h_6

$>18-30$ DIAMETER

DC = $+0,008/+0,029$
DCON = h_6

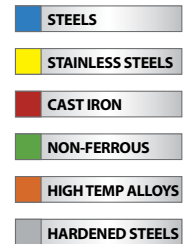

For patent information visit www.kspatents.com



FRACTIONAL & METRIC
Series 135

135 3xD

FRACTIONAL & METRIC SERIES

CONTINUED

DECIMAL DC	METRIC DC	inch & mm						EDP NO.
		FRACTIONAL/ LETTER/WIRE DC	SHANK DIAMETER DCON	OVERALL LENGTH OAL	FLUTE LENGTH LCF	USABLE LENGTH LU	SHANK LENGTH LS	Ti-NAMITE-A (AITIN)
0.1378	3,500 mm		6,0	62,0	20,0	15,0	36,0	63159
0.1405	3,569 mm	#28	1/4	2-1/2	3/4	35/64	1-7/16	51760
0.1406	3,571 mm	9/64	1/4	2-1/2	3/4	9/16	1-7/16	51332
0.1417	3,600 mm		6,0	62,0	20,0	15,0	36,0	63160
0.1440	3,658 mm	#27	1/4	2-1/2	3/4	35/64	1-7/16	51761
0.1457	3,700 mm		6,0	62,0	20,0	14,0	36,0	63161
0.1470	3,734 mm	#26	1/4	2-1/2	3/4	17/32	1-7/16	51762
0.1495	3,797 mm	#25	1/4	2-5/8	7/8	21/32	1-7/16	51333
0.1496	3,800 mm		6,0	66,0	24,0	18,0	36,0	63742
0.1520	3,861 mm	#24	1/4	2-5/8	7/8	21/32	1-7/16	51763
0.1535	3,900 mm		6,0	66,0	24,0	18,0	36,0	63743
0.1540	3,912 mm	#23	1/4	2-5/8	7/8	21/32	1-7/16	51764
0.1562	3,967 mm	5/32	1/4	2-5/8	7/8	41/64	1-7/16	51334
0.1570	3,988 mm	#22	1/4	2-5/8	7/8	41/64	1-7/16	51765
0.1575	4,000 mm		6,0	66,0	24,0	18,0	36,0	63162
0.1590	4,039 mm	#21	1/4	2-5/8	7/8	41/64	1-7/16	51335
0.1610	4,089 mm	#20	1/4	2-5/8	7/8	5/8	1-7/16	51279
0.1614	4,100 mm		6,0	66,0	24,0	18,0	36,0	63744
0.1654	4,200 mm		6,0	66,0	24,0	18,0	36,0	63163
0.1660	4,216 mm	#19	1/4	2-5/8	7/8	5/8	1-7/16	51766
0.1693	4,300 mm		6,0	66,0	24,0	18,0	36,0	63164
0.1695	4,305 mm	#18	1/4	2-5/8	7/8	5/8	1-7/16	51767
0.1719	4,366 mm	11/64	1/4	2-5/8	7/8	39/64	1-7/16	51336
0.1730	4,394 mm	#17	1/4	2-5/8	7/8	5/8	1-7/16	51768
0.1732	4,400 mm		6,0	66,0	24,0	17,0	36,0	63745
0.1770	4,496 mm	#16	1/4	2-5/8	7/8	39/64	1-7/16	51769
0.1772	4,500 mm		6,0	66,0	24,0	17,0	36,0	63165
0.1800	4,572 mm	#15	1/4	2-5/8	7/8	39/64	1-7/16	51770
0.1811	4,600 mm		6,0	66,0	24,0	17,0	36,0	63166
0.1820	4,623 mm	#14	1/4	2-5/8	7/8	39/64	1-7/16	51771
0.1850	4,699 mm	#13	1/4	2-5/8	7/8	39/64	1-7/16	51772
0.1850	4,699 mm	#13	6,0	66,0	24,0	17,0	36,0	63746
0.1875	4,763 mm	3/16	1/4	2-5/8	1	23/32	1-7/16	51337
0.1890	4,801 mm	#12	1/4	2-5/8	1	23/32	1-7/16	51773
0.1890	4,801 mm	#12	6,0	66,0	28,0	21,0	36,0	63167
0.1910	4,851 mm	#11	1/4	2-5/8	1	23/32	1-7/16	51774
0.1929	4,900 mm		6,0	66,0	28,0	21,0	36,0	63747
0.1935	4,915 mm	#10	1/4	2-5/8	1	23/32	1-7/16	51775
0.1960	4,978 mm	#9	1/4	2-5/8	1	23/32	1-7/16	51776
0.1969	5,000 mm		6,0	66,0	28,0	20,0	36,0	63168
0.1990	5,055 mm	#8	1/4	2-5/8	1	45/64	1-7/16	51777
0.2008	5,100 mm		6,0	66,0	28,0	20,0	36,0	63748
0.2010	5,105 mm	#7	1/4	2-5/8	1	45/64	1-7/16	51338
0.2031	5,159 mm	13/64	1/4	2-5/8	1	45/64	1-7/16	51339
0.2040	5,182 mm	#6	1/4	2-5/8	1	45/64	1-7/16	51778
0.2047	5,200 mm		6,0	66,0	28,0	20,0	36,0	63749

continued on next page

Series 135 3xD | Fractional & Metric

FRACTIONAL & METRIC Series 135



135 3xD

FRACTIONAL & METRIC SERIES

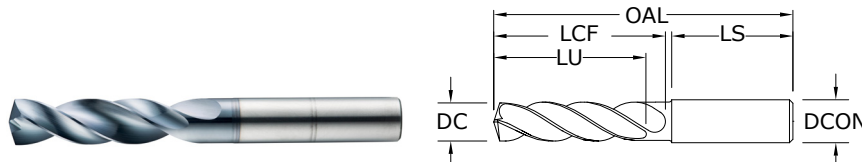

- 4-margin design improves accuracy and surface finish along with increased strength for aggressive drilling
- Specialized self-centering notched point eliminates the need for spot drilling decreasing thrust and deflection
- Engineered edge protection improves edge strength and reduces edge fatigue allowing for increased feed rates
- Recommended for materials ≤ 50 HRc (≤ 475 Bhn)

inch & mm									EDP NO.
DECIMAL DC	METRIC DC	FRACTIONAL/ LETTER/WIRE DC	SHANK DIAMETER DCON	OVERALL LENGTH OAL	FLUTE LENGTH LCF	USABLE LENGTH LU	SHANK LENGTH LS	Ti-NAMITE-A (AITIN)	
0.2055	5,220 mm	#5	1/4	2-5/8	1	45/64	1-7/16	51779	
0.2067	5,250 mm		6,0	66,0	28,0	20,0	36,0	63169	
0.2087	5,300 mm		6,0	66,0	28,0	20,0	36,0	63170	
0.2090	5,309 mm	#4	1/4	2-5/8	1	11/16	1-7/16	51780	
0.2126	5,400 mm		6,0	66,0	28,0	20,0	36,0	63750	
0.2130	5,410 mm	#3	1/4	2-5/8	1	11/16	1-7/16	51340	
0.2165	5,500 mm		6,0	66,0	28,0	20,0	36,0	63171	
0.2188	5,558 mm	7/32	1/4	2-5/8	1	43/64	1-7/16	51341	
0.2205	5,600 mm		6,0	66,0	28,0	20,0	36,0	63751	
0.2210	5,613 mm	#2	1/4	2-5/8	1	11/16	1-7/16	51781	
0.2244	5,700 mm		6,0	66,0	28,0	19,0	36,0	63752	
0.2280	5,791 mm	#1	1/4	2-5/8	1	21/32	1-7/16	51782	
0.2283	5,800 mm		6,0	66,0	28,0	19,0	36,0	63172	
0.2323	5,900 mm		6,0	66,0	28,0	19,0	36,0	63753	
0.2340	5,944 mm	A	1/4	2-5/8	1	21/32	1-7/16	51601	
0.2344	5,954 mm	15/64	1/4	2-5/8	1	21/32	1-7/16	51342	
0.2362	6,000 mm		6,0	66,0	28,0	19,0	36,0	63173	
0.2380	6,045 mm	B	1/4	3-1/8	1-5/16	31/32	1-7/16	51602	
0.2402	6,100 mm		8,0	79,0	34,0	25,0	36,0	63754	
0.2420	6,147 mm	C	1/4	3-1/8	1-5/16	61/64	1-7/16	51603	
0.2441	6,200 mm		8,0	79,0	34,0	25,0	36,0	63755	
0.2460	6,248 mm	D	1/4	3-1/8	1-5/16	61/64	1-7/16	51604	
0.2461	6,250 mm		8,0	79,0	34,0	25,0	36,0	63174	
0.2480	6,300 mm		8,0	79,0	34,0	25,0	36,0	63756	
0.2500	6,350 mm	1/4 E #0	1/4	3-1/8	1-5/16	15/16	1-7/16	51343	
0.2520	6,400 mm		8,0	79,0	34,0	24,0	36,0	63175	
0.2559	6,500 mm		8,0	79,0	34,0	24,0	36,0	63213	
0.2570	6,528 mm	F	5/16	3-1/8	1-5/16	59/64	1-7/16	51344	
0.2598	6,600 mm		8,0	79,0	34,0	24,0	36,0	63757	
0.2610	6,629 mm	G	5/16	3-1/8	1-5/16	59/64	1-7/16	51606	
0.2638	6,700 mm		8,0	79,0	34,0	24,0	36,0	63758	
0.2656	6,746 mm	17/64	5/16	3-1/8	1-5/16	59/64	1-7/16	51345	
0.2660	6,756 mm	H	5/16	3-1/8	1-5/16	59/64	1-7/16	51607	
0.2677	6,800 mm		8,0	79,0	34,0	24,0	36,0	63176	
0.2717	6,900 mm		8,0	79,0	34,0	24,0	36,0	63759	
0.2720	6,909 mm	I	5/16	3-1/8	1-5/16	29/32	1-7/16	51346	
0.2756	7,000 mm		8,0	79,0	34,0	24,0	36,0	63177	
0.2770	7,036 mm	J	5/16	3-1/8	1-5/16	29/32	1-7/16	51608	

TOLERANCES (inch)

- ≤.1181 DIAMETER**
DC = +.00008/+0.00047
DCON = h_6
- >.1181-.2362 DIAMETER**
DC = +.00016/+0.00063
DCON = h_6
- >.2362-.3937 DIAMETER**
DC = +.00024/+0.00083
DCON = h_6
- >.3937-.7087 DIAMETER**
DC = +.00028/+0.00098
DCON = h_6
- >.7087-1.1811 DIAMETER**
DC = +.00031/+0.00114
DCON = h_6

TOLERANCES (mm)

- ≤3 DIAMETER**
DC = +0,002/+0,012
DCON = h_6
- >3-6 DIAMETER**
DC = +0,004/+0,016
DCON = h_6
- >6-10 DIAMETER**
DC = +0,006/+0,021
DCON = h_6
- >10-18 DIAMETER**
DC = +0,007/+0,025
DCON = h_6
- >18-30 DIAMETER**
DC = +0,008/+0,029
DCON = h_6

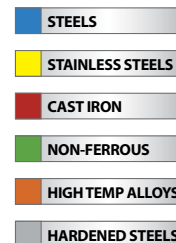

For patent information visit www.kspatents.com

continued on next page



FRACTIONAL & METRIC Series 135

135 3xD

FRACTIONAL & METRIC SERIES

CONTINUED

DECIMAL DC	METRIC DC	inch & mm						EDP NO.
		FRACTIONAL/ LETTER/WIRE DC	SHANK DIAMETER DCON	OVERALL LENGTH OAL	FLUTE LENGTH LCF	USABLE LENGTH LU	SHANK LENGTH LS	Ti-NAMITE-A (AITiN)
0.2795	7,100 mm		8,0	79,0	41,0	30,0	36,0	63760
0.2810	7,137 mm	K	5/16	3-1/8	1-9/16	1-9/64	1-7/16	51609
0.2812	7,142 mm	9/32	5/16	3-1/8	1-9/16	1-9/64	1-7/16	51347
0.2835	7,200 mm		8,0	79,0	41,0	30,0	36,0	63761
0.2854	7,250 mm		8,0	79,0	41,0	30,0	36,0	63178
0.2874	7,300 mm		8,0	79,0	41,0	30,0	36,0	63762
0.2900	7,366 mm	L	5/16	3-1/8	1-9/16	1-1/8	1-7/16	51610
0.2913	7,400 mm		8,0	79,0	41,0	30,0	36,0	63763
0.2950	7,493 mm	M	5/16	3-1/8	1-9/16	1-1/8	1-7/16	51611
0.2953	7,500 mm		8,0	79,0	41,0	30,0	36,0	63179
0.2969	7,541 mm	19/64	5/16	3-1/8	1-9/16	1-7/64	1-7/16	51348
0.2992	7,600 mm		8,0	79,0	41,0	30,0	36,0	63764
0.3020	7,671 mm	N	5/16	3-1/8	1-9/16	1-7/64	1-7/16	51612
0.3031	7,700 mm		8,0	79,0	41,0	29,0	36,0	63765
0.3071	7,800 mm		8,0	79,0	41,0	29,0	36,0	63180
0.3110	7,900 mm		8,0	79,0	41,0	29,0	36,0	63766
0.3125	7,938 mm	5/16	5/16	3-1/8	1-9/16	1-3/32	1-7/16	51349
0.3150	8,000 mm		8,0	79,0	41,0	29,0	36,0	63181
0.3160	8,026 mm	O	3/8	3-1/2	1-27/32	1-3/8	1-9/16	51613
0.3189	8,100 mm		10,0	89,0	47,0	35,0	40,0	63767
0.3228	8,200 mm		10,0	89,0	47,0	35,0	40,0	63768
0.3230	8,204 mm	P	3/8	3-1/2	1-27/32	1-23/64	1-9/16	51614
0.3268	8,300 mm		10,0	89,0	47,0	35,0	40,0	63769
0.3281	8,334 mm	21/64	3/8	3-1/2	1-27/32	1-23/64	1-9/16	51350
0.3307	8,400 mm		10,0	89,0	47,0	34,0	40,0	63182
0.3320	8,433 mm	Q	3/8	3-1/2	1-27/32	1-11/32	1-9/16	51351
0.3346	8,500 mm		10,0	89,0	47,0	34,0	40,0	63183
0.3386	8,600 mm		10,0	89,0	47,0	34,0	40,0	63770
0.3390	8,611 mm	R	3/8	3-1/2	1-27/32	1-11/32	1-9/16	51615
0.3425	8,700 mm		10,0	89,0	47,0	34,0	40,0	63771
0.3438	8,733 mm	11/32	3/8	3-1/2	1-27/32	1-21/64	1-9/16	51352
0.3465	8,800 mm		10,0	89,0	47,0	34,0	40,0	63184
0.3480	8,839 mm	S	3/8	3-1/2	1-27/32	1-21/64	1-9/16	51616
0.3504	8,900 mm		10,0	89,0	47,0	34,0	40,0	63772
0.3543	9,000 mm		10,0	89,0	47,0	34,0	40,0	63185
0.3580	9,093 mm	T	3/8	3-1/2	1-27/32	1-5/16	1-9/16	51617
0.3583	9,100 mm		10,0	89,0	47,0	33,0	40,0	63773
0.3594	9,129 mm	23/64	3/8	3-1/2	1-27/32	1-21/64	1-9/16	51353
0.3622	9,200 mm		10,0	89,0	47,0	33,0	40,0	63774
0.3642	9,250 mm		10,0	89,0	47,0	33,0	40,0	63186
0.3661	9,300 mm		10,0	89,0	47,0	33,0	40,0	63775
0.3680	9,347 mm	U	3/8	3-1/2	1-27/32	1-19/64	1-9/16	51354
0.3701	9,400 mm		10,0	89,0	47,0	33,0	40,0	63776
0.3740	9,500 mm		10,0	89,0	47,0	33,0	40,0	63187

continued on next page

Series 135 3xD | Fractional & Metric

FRACTIONAL & METRIC Series 135



135 3xD FRACTIONAL & METRIC SERIES

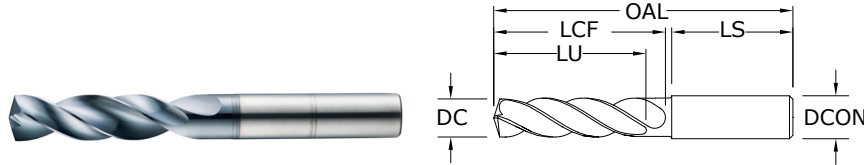

- 4-margin design improves accuracy and surface finish along with increased strength for aggressive drilling
- Specialized self-centering notched point eliminates the need for spot drilling decreasing thrust and deflection
- Engineered edge protection improves edge strength and reduces edge fatigue allowing for increased feed rates
- Recommended for materials ≤ 50 HRC (≤ 475 Bhn)

		inch & mm							EDP NO.
DECIMAL DC	METRIC DC	FRACTIONAL/ LETTER/WIRE DC	SHANK DIAMETER DCON	OVERALL LENGTH OAL	FLUTE LENGTH LCF	USABLE LENGTH LU	SHANK LENGTH LS	Ti-NAMITE-A (AITiN)	
0.3750	9,525 mm	3/8	3/8	3-1/2	1-27/32	1-9/32	1-9/16	51355	
0.3770	9,576 mm	V	1/2	3-1/2	1-27/32	1-9/32	1-9/16	51618	
0.3780	9,600 mm		10,0	89,0	47,0	33,0	40,0	63777	
0.3819	9,700 mm		10,0	89,0	47,0	32,0	40,0	63778	
0.3858	9,800 mm		10,0	89,0	47,0	32,0	40,0	63779	
0.3860	9,804 mm	W	1/2	3-1/2	1-27/32	1-17/64	1-9/16	51619	
0.4095	10,400 mm		10,0	89,0	47,0	32,0	40,0	63780	
0.4130	10,490 mm	Z	1/2	3-1/2	1-27/32	1-17/64	1-9/16	51356	
0.4134	10,500 mm		10,0	89,0	47,0	32,0	40,0	63188	
0.4173	10,600 mm		1/2	4-1/16	2-3/16	1-19/32	1-49/64	51620	
0.4213	10,700 mm		12,0	102,0	55,0	40,0	45,0	63781	
0.4219	10,716 mm	27/64	12,0	102,0	55,0	40,0	45,0	63189	
0.4252	10,800 mm		1/2	4-1/16	2-3/16	1-19/32	1-49/64	51621	
0.4291	10,900 mm		12,0	102,0	55,0	40,0	45,0	63782	
0.4331	11,000 mm		1/2	4-1/16	2-3/16	1-37/64	1-49/64	51357	
0.4370	11,100 mm		12,0	102,0	55,0	39,0	45,0	63783	
0.4375	11,113 mm	7/16	1/2	4-1/16	2-3/16	1-37/64	1-49/64	51622	
0.4409	11,200 mm		12,0	102,0	55,0	39,0	45,0	63190	
0.4429	11,250 mm		12,0	102,0	55,0	39,0	45,0	63784	
0.4449	11,300 mm		12,0	102,0	55,0	39,0	45,0	63785	
0.4488	11,400 mm		1/2	4-1/16	2-3/16	1-9/16	1-49/64	51358	
0.4252	10,800 mm		12,0	102,0	55,0	39,0	45,0	63191	
0.4291	10,900 mm		12,0	102,0	55,0	39,0	45,0	63786	
0.4331	11,0 mm		12,0	102,0	55,0	39,0	45,0	63192	
0.4331	11,000 mm		12,0	102,0	55,0	38,0	45,0	63787	
0.4370	11,100 mm		1/2	4-1/16	2-3/16	1-17/32	1-49/64	51359	
0.4375	11,113 mm	7/16	12,0	102,0	55,0	38,0	45,0	63788	
0.4409	11,200 mm		12,0	102,0	55,0	38,0	45,0	63193	
0.4429	11,250 mm		12,0	102,0	55,0	38,0	45,0	63789	
0.4449	11,300 mm		12,0	102,0	55,0	38,0	45,0	63790	
0.4488	11,400 mm		12,0	102,0	55,0	38,0	45,0	63194	
0.4531	11,509 mm	29/64	1/2	4-1/16	2-3/16	1-33/64	1-49/64	51360	
0.4567	11,600 mm		12,0	102,0	55,0	38,0	45,0	63791	
0.4606	11,700 mm		12,0	102,0	55,0	37,0	45,0	63792	
0.4646	11,800 mm		12,0	102,0	55,0	37,0	45,0	63793	
0.4685	11,900 mm		12,0	102,0	55,0	37,0	45,0	63794	
0.4688	11,908 mm	15/32	1/2	4-1/16	2-3/16	1-31/64	1-49/64	51361	
0.4724	12,000 mm		12,0	102,0	55,0	37,0	45,0	63195	

TOLERANCES (inch)

- ≤.1181 DIAMETER**
DC = +.00008/+0.00047
DCON = h₆
- >.1181-.2362 DIAMETER**
DC = +.00016/+0.00063
DCON = h₆
- >.2362-.3937 DIAMETER**
DC = +.00024/+0.00083
DCON = h₆
- >.3937-.7087 DIAMETER**
DC = +.00028/+0.00098
DCON = h₆
- >.7087-1.1811 DIAMETER**
DC = +.00031/+0.00114
DCON = h₆

TOLERANCES (mm)

- ≤3 DIAMETER**
DC = +0,002/+0,012
DCON = h₆
- >3-6 DIAMETER**
DC = +0,004/+0,016
DCON = h₆
- >6-10 DIAMETER**
DC = +0,006/+0,021
DCON = h₆
- >10-18 DIAMETER**
DC = +0,007/+0,025
DCON = h₆
- >18-30 DIAMETER**
DC = +0,008/+0,029
DCON = h₆

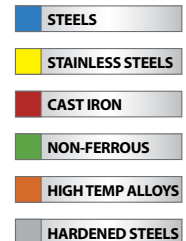

For patent information visit www.kspatents.com

continued on next page



FRACTIONAL & METRIC Series 135

135 3xD

FRACTIONAL & METRIC SERIES

CONTINUED

DECIMAL DC	METRIC DC	inch & mm						EDP NO. Ti-NAMITE-A (AITiN)
		FRACTIONAL/ LETTER/WIRE DC	SHANK DIAMETER DCON	OVERALL LENGTH OAL	FLUTE LENGTH LCF	USABLE LENGTH LU	SHANK LENGTH LS	
0.4844	12,304 mm	31/64	1/2	4-1/4	2-5/16	1-19/32	1-49/64	51362
0.4921	12,500 mm		14,0	107,0	60,0	41,0	45,0	63196
0.5000	12,700 mm	1/2	1/2	4-1/4	2-5/16	1-9/16	1-49/64	51363
0.5039	12,800 mm		14,0	107,0	60,0	41,0	45,0	63197
0.5118	13,000 mm		14,0	107,0	60,0	41,0	45,0	63198
0.5156	13,096 mm	33/64	5/8	4-1/4	2-5/16	1-35/64	1-49/64	51364
0.5312	13,492 mm	17/32	5/8	4-1/4	2-5/16	1-33/64	1-49/64	51365
0.5315	13,500 mm		14,0	107,0	60,0	40,0	45,0	63199
0.5469	13,8 mm	35/64	5/8	4-1/4	2-5/16	1-1/2	1-49/64	51783
0.5469	13,891 mm	35/64	14,0	107,0	60,0	39,0	45,0	63200
0.5512	14,000 mm		5/8	4-9/16	2-1/2	1-21/32	1-57/64	51366
0.5625	14,288 mm	9/16	16,0	115,0	65,0	43,0	48,0	63201
0.5781	14,684 mm	37/64	5/8	4-9/16	2-1/2	1-41/64	1-57/64	51367
0.5906	15,000 mm		16,0	115,0	65,0	42,0	48,0	63202
0.5938	15,083 mm	19/32	5/8	4-9/16	2-1/2	1-39/64	1-57/64	51784
0.6094	15,479 mm	39/64	5/8	4-9/16	2-1/2	1-19/32	1-57/64	51785
0.6102	15,500 mm		16,0	115,0	65,0	42,0	48,0	63203
0.6250	15,875 mm	5/8	5/8	4-9/16	2-1/2	1-9/16	1-57/64	51368
0.6299	16,000 mm		16,0	115,0	65,0	41,0	48,0	63204
0.6406	16,271 mm	41/64	3/4	4-7/8	2-3/4	1-51/64	1-57/64	51786
0.6496	16,500 mm		18,0	123,0	73,0	48,0	48,0	63205
0.6562	16,667 mm	21/32	3/4	4-7/8	2-3/4	1-25/32	1-57/64	51369
0.6693	17,000 mm		18,0	123,0	73,0	47,0	48,0	63206
0.6719	17,066 mm	43/64	3/4	4-7/8	2-3/4	1-3/4	1-57/64	51787
0.6875	17,463 mm	11/16	3/4	4-7/8	2-3/4	1-47/64	1-57/64	51370
0.6890	17,500 mm		18,0	123,0	73,0	47,0	48,0	63207
0.7031	17,859 mm	45/64	3/4	4-7/8	2-3/4	1-45/64	1-57/64	51788
0.7087	18,000 mm		18,0	123,0	73,0	46,0	48,0	63208
0.7188	18,258 mm	23/32	3/4	4-7/8	2-3/4	1-43/64	1-57/64	51789
0.7283	18,500 mm		20,0	131,0	79,0	51,0	50,0	63209
0.7344	18,654 mm	47/64	3/4	4-7/8	2-3/4	1-21/32	1-57/64	51790
0.7480	19,000 mm		20,0	131,0	79,0	51,0	50,0	63210
0.7500	19,050 mm	3/4	3/4	5-1/4	3-1/16	1-15/16	1-31/32	51371
0.7656	19,446 mm	49/64	7/8	5-1/4	3-1/16	1-59/64	1-31/32	51372
0.7677	19,500 mm		20,0	131,0	79,0	50,0	50,0	63211
0.7812	19,842 mm	25/32	7/8	6	3-11/16	2-33/64	2-1/8	51791
0.7874	2,0000 mm		20,0	131,0	79,0	49,0	50,0	63212
0.7969	20,241 mm	51/64	7/8	6	3-11/16	2-1/2	2-1/8	51792
0.8071	20,500 mm		22,0	150,0	93,0	62,0	53,0	64513
0.8125	20,638 mm	13/16	7/8	6	3-11/16	2-15/32	2-1/8	51373
0.8268	21,000 mm		22,0	150,0	93,0	61,0	53,0	64514
0.8661	22,000 mm		22,0	150,0	93,0	60,0	53,0	64515
0.8750	22,225 mm	7/8	7/8	6	3-11/16	2-3/8	2-1/8	51374
0.9219	23,416 mm	59/64	1	6	3-11/16	2-5/16	2-1/8	51375

Series 135 3xD | Fractional & Metric

FRACTIONAL
Series 135



Series 135 | Speed & Feed Recommendations

Series 135 3D Fractional	Hardness	Vc (sfm)	DC • in								
			1/32	1/8	1/4	3/8	1/2	5/8	7/8		
CARBON STEELS 1018, 1040, 1080, 1090, 10L50, 1140, 1212, 12L15, 1525, 1536	≤ 175 Bhn or ≤ 7 HRc	385	RPM	47062	11766	5883	3922	2941	2353	1681	
		(308-462)	Fr	0.0010	0.0038	0.0076	0.0115	0.0153	0.0191	0.0268	
			Feed (ipm)	45.0	45.0	45.0	45.0	45.0	45.0	45.0	
	≤ 275 Bhn or ≤ 28 HRc	350	RPM	42784	10696	5348	3565	2674	2139	1528	
		(280-420)	Fr	0.0009	0.0036	0.0071	0.0107	0.0142	0.0178	0.0249	
			Feed (ipm)	38.0	38.0	38.0	38.0	38.0	38.0	38.0	
	≤ 425 Bhn or ≤ 45 HRc	200	RPM	24448	6112	3056	2037	1528	1222	873	
		(160-240)	Fr	0.0007	0.0029	0.0059	0.0088	0.0118	0.0147	0.0206	
			Feed (ipm)	18.0	18.0	18.0	18.0	18.0	18.0	18.0	
	ALLOY STEELS 4140, 4150, 4320, 5120, 5150, 8630, 86L20, 50100	≤ 275 Bhn or ≤ 28 HRc	300	RPM	36672	9168	4584	3056	2292	1834	1310
			(240-360)	Fr	0.0007	0.0029	0.0059	0.0088	0.0118	0.0147	0.0206
				Feed (ipm)	27.0	27.0	27.0	27.0	27.0	27.0	27.0
≤ 375 Bhn or ≤ 40 HRc		185	RPM	22614	5654	2827	1885	1413	1131	808	
		(148-222)	Fr	0.0006	0.0026	0.0051	0.0077	0.0103	0.0128	0.0180	
			Feed (ipm)	14.5	14.5	14.5	14.5	14.5	14.5	14.5	
≤ 425 Bhn or ≤ 45 HRc		130	RPM	15891	3973	1986	1324	993	795	568	
		(104-156)	Fr	0.0004	0.0018	0.0035	0.0053	0.0070	0.0088	0.0123	
			Feed (ipm)	7.0	7.0	7.0	7.0	7.0	7.0	7.0	
TOOL STEELS A2, D2, H13, L2, M2, P20, S7, T15, W2		≤ 200 Bhn or ≤ 13 HRc	130	RPM	15891	3973	1986	1324	993	795	568
			(104-156)	Fr	0.0007	0.0026	0.0053	0.0079	0.0106	0.0132	0.0185
				Feed (ipm)	10.5	10.5	10.5	10.5	10.5	10.5	10.5
	≤ 375 Bhn or ≤ 40 HRc	90	RPM	11002	2750	1375	917	688	550	393	
		(72-108)	Fr	0.0003	0.0012	0.0023	0.0035	0.0047	0.0058	0.0081	
			Feed (ipm)	3.2	3.2	3.2	3.2	3.2	3.2	3.2	
STAINLESS STEELS (FREE MACHINING) 303, 416, 420F, 430F, 440F	≤ 185 Bhn or ≤ 9 HRc	275	RPM	33616	8404	4202	2801	2101	1681	1201	
		(220-330)	Fr	0.0006	0.0026	0.0051	0.0077	0.0102	0.0128	0.0179	
			Feed (ipm)	21.5	21.5	21.5	21.5	21.5	21.5	21.5	
	≤ 275 Bhn or ≤ 28 HRc	170	RPM	20781	5195	2598	1732	1299	1039	742	
		(136-204)	Fr	0.0005	0.0020	0.0040	0.0061	0.0081	0.0101	0.0141	
			Feed (ipm)	10.5	10.5	10.5	10.5	10.5	10.5	10.5	
	STAINLESS STEELS (DIFFICULT) 304, 316, 321, 13-8 PH, 15-5PH, 17-4 PH, Custom 450	≤ 275 Bhn or ≤ 28 HRc	90	RPM	11002	2750	1375	917	688	550	393
			(72-108)	Fr	0.0005	0.0020	0.0040	0.0060	0.0080	0.0100	0.0140
				Feed (ipm)	5.5	5.5	5.5	5.5	5.5	5.5	5.5
		≤ 375 Bhn or ≤ 40 HRc	65	RPM	7946	1986	993	662	497	397	284
			(52-78)	Fr	0.0004	0.0018	0.0035	0.0053	0.0070	0.0088	0.0123
				Feed (ipm)	3.5	3.5	3.5	3.5	3.5	3.5	3.5
CAST IRONS Gray, Malleable, Ductile	≤ 220 Bhn or ≤ 19 HRc	320	RPM	39117	9779	4890	3260	2445	1956	1397	
		(256-384)	Fr	0.0012	0.0046	0.0092	0.0138	0.0184	0.0230	0.0322	
			Feed (ipm)	45.0	45.0	45.0	45.0	45.0	45.0	45.0	
	≤ 260 Bhn or ≤ 26 HRc	285	RPM	34838	8710	4355	2903	2177	1742	1244	
		(228-342)	Fr	0.0011	0.0046	0.0092	0.0138	0.0184	0.0230	0.0321	
			Feed (ipm)	40.0	40.0	40.0	40.0	40.0	40.0	40.0	

continued on next page

Series 135 3D Fractional	Hardness	Vc (sfm)	DC • in									
			1/32	1/8	1/4	3/8	1/2	5/8	7/8			
N	ALUMINUM ALLOYS 2017, 2024, 356, 6061, 7075	≤ 80 Bhn or ≤ 47 HRb	700	RPM	85568	21392	10696	7131	5348	4278	3056	
				Fr	0.0012	0.0049	0.0098	0.0147	0.0196	0.0245	0.0344	
			(560-840)	Feed (ipm)	105.0	105.0	105.0	105.0	105.0	105.0	105.0	
			600	RPM	73344	18336	9168	6112	4584	3667	2619	
			≤ 150 Bhn or ≤ 88 HRb		Fr	0.0012	0.0050	0.0099	0.0149	0.0199	0.0248	0.0347
			(480-720)	Feed (ipm)	91.0	91.0	91.0	91.0	91.0	91.0	91.0	
	COPPER ALLOYS Alum Bronze, C110, Muntz Brass	≤ 140 Bhn or ≤ 3 HRc	500	RPM	61120	15280	7640	5093	3820	3056	2183	
				Fr	0.0005	0.0020	0.0039	0.0059	0.0079	0.0098	0.0137	
			(400-600)	Feed (ipm)	30.0	30.0	30.0	30.0	30.0	30.0	30.0	
			400	RPM	48896	12224	6112	4075	3056	2445	1746	
			≤ 200 Bhn or ≤ 23 HRc		Fr	0.0005	0.0020	0.0040	0.0060	0.0080	0.0100	0.0140
			(320-480)	Feed (ipm)	24.5	24.5	24.5	24.5	24.5	24.5	24.5	
S	HIGH TEMP ALLOYS (NICKEL, COBALT, IRON BASE) Inconel 601, 617, 625, Incoloy, Monel 400, Rene, Waspaloy	≤ 300 Bhn or ≤ 32 HRc	55	RPM	6723	1681	840	560	420	336	240	
				Fr	0.0002	0.0008	0.0015	0.0023	0.0031	0.0039	0.0054	
			(44-66)	Feed (ipm)	1.3	1.3	1.3	1.3	1.3	1.3	1.3	
			30	RPM	3667	917	458	306	229	183	131	
			≤ 400 Bhn or ≤ 43 HRc		Fr	0.0002	0.0007	0.0013	0.0020	0.0026	0.0033	0.0046
			(24-36)	Feed (ipm)	0.6	0.6	0.6	0.6	0.6	0.6	0.6	
	TITANIUM ALLOYS Pure Titanium, Ti6Al4V, Ti6Al2Sn4Zr2Mo, Ti4Al4Mo2Sn0.5Si, Ti-6Al4V	≤ 275 Bhn or ≤ 28 HRc	135	RPM	16502	4126	2063	1375	1031	825	589	
				Fr	0.0004	0.0018	0.0035	0.0053	0.0071	0.0088	0.0124	
			(108-162)	Feed (ipm)	7.3	7.3	7.3	7.3	7.3	7.3	7.3	
			100	RPM	12224	3056	1528	1019	764	611	437	
			≤ 350 Bhn or ≤ 38 HRc		Fr	0.0004	0.0016	0.0033	0.0049	0.0065	0.0082	0.0115
			(80-120)	Feed (ipm)	5.0	5.0	5.0	5.0	5.0	5.0	5.0	
H	TOOL STEELS A2, D2, H13, L2, M2, P20, S7, T15, W2	≤ 440 Bhn or ≤ 47 HRc	55	RPM	6723	1681	840	560	420	336	240	
				Fr	0.0003	0.0012	0.0024	0.0036	0.0048	0.0059	0.0083	
			(44-66)	Feed (ipm)	2.0	2.0	2.0	2.0	2.0	2.0	2.0	
			75	RPM	9168	2292	1146	764	573	458	327	
			≤ 475 Bhn or ≤ 50 HRc		Fr	0.0002	0.0008	0.0016	0.0024	0.0031	0.0039	0.0055
			(60-90)	Feed (ipm)	1.8	1.8	1.8	1.8	1.8	1.8	1.8	

Bhn (Brinell) HRc (Rockwell C) HRb (Rockwell B)
 rpm = Vc x 3.82 / DC
 ipm = Fr x rpm
 reduce speed and feed for materials harder than listed
 refer to the SGS Tool Wizard® for complete technical information (www.kyocera-sgstool.com)

METRIC
Series 135



Series 135 | Speed & Feed Recommendations

Series 135 3D Metric	Hardness	Vc (m/min)	DC • mm								
			1.5	3	6	8	10	12	16	20	
CARBON STEELS 1018, 1040, 1080, 1090, 10L50, 1140, 1212, 12L15, 1525, 1536	≤ 175 Bhn or ≤ 7 HRc	117	RPM	24882	12441	6220	4665	3732	3110	2333	1866
		(94-141)	Fr	0.047	0.094	0.189	0.252	0.315	0.378	0.504	0.630
			Feed (mm/min)	1175	1175	1175	1175	1175	1175	1175	1175
	≤ 275 Bhn or ≤ 28 HRc	107	RPM	22620	11310	5655	4241	3393	2827	2121	1696
		(85-128)	Fr	0.043	0.086	0.172	0.229	0.286	0.343	0.457	0.572
			Feed (mm/min)	970	970	970	970	970	970	970	970
	≤ 475 Bhn or ≤ 45 HRc	61	RPM	12926	6463	3231	2424	1939	1616	1212	969
		(49-73)	Fr	0.036	0.071	0.142	0.190	0.237	0.285	0.380	0.475
			Feed (mm/min)	460	460	460	460	460	460	460	460
ALLOY STEELS 4140, 4150, 4320, 5120, 5150, 8630, 86L20, 50100	≤ 275 Bhn or ≤ 28 HRc	91	RPM	19388	9694	4847	3635	2908	2424	1818	1454
		(73-110)	Fr	0.036	0.071	0.142	0.190	0.237	0.285	0.380	0.475
			Feed (mm/min)	690	690	690	690	690	690	690	690
	≤ 375 Bhn or ≤ 40 HRc	56	RPM	11956	5978	2989	2242	1793	1495	1121	897
		(45-68)	Fr	0.031	0.061	0.122	0.163	0.204	0.244	0.326	0.407
			Feed (mm/min)	365	365	365	365	365	365	365	365
	≤ 425 Bhn or ≤ 45 HRc	40	RPM	8402	4201	2100	1575	1260	1050	788	630
		(32-48)	Fr	0.021	0.042	0.083	0.111	0.139	0.167	0.222	0.278
			Feed (mm/min)	175	175	175	175	175	175	175	175
TOOL STEELS A2, D2, H13, L2, M2, P20, S7, T15, W2	≤ 200 Bhn or ≤ 13 HRc	40	RPM	8402	4201	2100	1575	1260	1050	788	630
		(32-48)	Fr	0.032	0.063	0.126	0.168	0.210	0.252	0.336	0.421
			Feed (mm/min)	265	265	265	265	265	265	265	265
	≤ 375 Bhn or ≤ 40 HRc	27	RPM	5816	2908	1454	1091	872	727	545	436
		(22-33)	Fr	0.014	0.028	0.055	0.073	0.092	0.110	0.147	0.183
			Feed (mm/min)	80	80	80	80	80	80	80	80
STAINLESS STEELS (FREE MACHINING) 303, 416, 420F, 430F, 440F	≤ 185 Bhn or ≤ 9 HRc	84	RPM	17773	8886	4443	3332	2666	2222	1666	1333
		(67-101)	Fr	0.031	0.061	0.123	0.164	0.204	0.245	0.327	0.409
			Feed (mm/min)	545	545	545	545	545	545	545	545
	≤ 275 Bhn or ≤ 28 HRc	52	RPM	10987	5493	2747	2060	1648	1373	1030	824
		(41-62)	Fr	0.024	0.047	0.095	0.126	0.158	0.189	0.252	0.316
			Feed (mm/min)	260	260	260	260	260	260	260	260
STAINLESS STEELS (DIFFICULT) 304, 316, 321, 13-8 PH, 15-5PH, 17-4 PH, Custom 450	≤ 275 Bhn or ≤ 28 HRc	27	RPM	5816	2908	1454	1091	872	727	545	436
		(22-33)	Fr	0.023	0.046	0.093	0.124	0.155	0.186	0.248	0.309
			Feed (mm/min)	135	135	135	135	135	135	135	135
	≤ 375 Bhn or ≤ 40 HRc	20	RPM	4201	2100	1050	788	630	525	394	315
		(16-24)	Fr	0.020	0.040	0.081	0.108	0.135	0.162	0.216	0.270
			Feed (mm/min)	85	85	85	85	85	85	85	85
CAST IRONS Gray, Malleable, Ductile	≤ 220 Bhn or ≤ 19 HRc	98	RPM	20681	10340	5170	3878	3102	2585	1939	1551
		(78-117)	Fr	0.055	0.110	0.220	0.293	0.366	0.439	0.585	0.732
			Feed (mm/min)	1135	1135	1135	1135	1135	1135	1135	1135
	≤ 260 Bhn or ≤ 26 HRc	87	RPM	18419	9209	4605	3454	2763	2302	1727	1381
		(69-104)	Fr	0.055	0.110	0.219	0.292	0.366	0.439	0.585	0.731
			Feed (mm/min)	1010	1010	1010	1010	1010	1010	1010	1010

continued on next page

Series 135 3D Metric	Hardness	Vc (m/min)	DC • mm									
			1.5	3	6	8	10	12	16	20		
N ALUMINUM ALLOYS 2017, 2024, 356, 6061, 7075	≤ 80 Bhn or ≤ 47 HRb	213	RPM	45239	22620	11310	8482	6786	5655	4241	3393	
		(171-256)	Fr	0.059	0.119	0.238	0.317	0.396	0.476	0.634	0.793	
			Feed (mm/min)	2690	2690	2690	2690	2690	2690	2690	2690	
	≤ 150 Bhn or ≤ 8 HRb	183	RPM	38777	19388	9694	7271	5816	4847	3635	2908	
		(146-219)	Fr	0.060	0.120	0.240	0.320	0.400	0.480	0.640	0.799	
			Feed (mm/min)	2325	2325	2325	2325	2325	2325	2325	2325	
	COPPER ALLOYS Alum Bronze, C110, Muntz Brass	≤ 140 Bhn or ≤ 3 HRc	152	RPM	32314	16157	8078	6059	4847	4039	3029	2424
			(122-183)	Fr	0.024	0.048	0.096	0.128	0.160	0.192	0.256	0.320
				Feed (mm/min)	776	776	776	776	776	776	776	776
		≤ 200 Bhn or ≤ 23 HRc	122	RPM	25851	12926	6463	4847	3878	3231	2424	1939
			(98-146)	Fr	0.024	0.049	0.097	0.130	0.162	0.195	0.260	0.325
				Feed (mm/min)	630	630	630	630	630	630	630	630
S HIGH TEMP ALLOYS (NICKEL, COBALT, IRON BASE) Inconel 601, 617, 625, Incoloy, Monel 400, Rene, Waspaloy	≤ 300 Bhn or ≤ 32 HRc	17	RPM	3555	1777	889	666	533	444	333	267	
		(13-20)	Fr	0.010	0.020	0.039	0.053	0.066	0.079	0.105	0.131	
			Feed (mm/min)	35	35	35	35	35	35	35	35	
	≤ 400 Bhn or ≤ 43 HRc	9	RPM	1939	969	485	364	291	242	182	145	
		(7-11)	Fr	0.008	0.015	0.031	0.041	0.052	0.062	0.083	0.103	
			Feed (mm/min)	15	15	15	15	15	15	15	15	
	TITANIUM ALLOYS Pure Titanium, Ti6Al4V, Ti6Al2Sn4Zr2Mo, Ti4Al4Mo2Sn0.5Si, Ti-6Al4V	≤ 275 Bhn or ≤ 28 HRc	41	RPM	8725	4362	2181	1636	1309	1091	818	654
			(33-49)	Fr	0.021	0.042	0.085	0.113	0.141	0.170	0.226	0.283
				Feed (mm/min)	185	185	185	185	185	185	185	185
		≤ 350 Bhn or ≤ 38 HRc	30	RPM	6463	3231	1616	1212	969	808	606	485
			(24-37)	Fr	0.019	0.039	0.077	0.103	0.129	0.155	0.206	0.258
				Feed (mm/min)	125	125	125	125	125	125	125	125
≤ 440 Bhn or ≤ 47 HRc	17	RPM	3555	1777	889	666	533	444	333	267		
	(13-20)	Fr	0.014	0.028	0.056	0.075	0.094	0.113	0.150	0.188		
		Feed (mm/min)	50	50	50	50	50	50	50	50		
H TOOL STEELS A2, D2, H13, L2, M2, P20, S7, T15, W2	≤ 475 Bhn or ≤ 50 HRc	23	RPM	4847	2424	1212	909	727	606	454	364	
		(18-27)	Fr	0.009	0.019	0.037	0.050	0.062	0.074	0.099	0.124	
			Feed (mm/min)	45	45	45	45	45	45	45	45	

Bhn (Brinell) HRc (Rockwell C) HRb (Rockwell B)
 $rpm = (Vc \times 1000) / (DC \times 3.14)$
 $mm/min = Fr \times rpm$
 reduce speed and feed for materials harder than listed
 refer to the SGS Tool Wizard® for complete technical information (www.kyocera-sgstool.com)

FRACTIONAL & METRIC Series 135

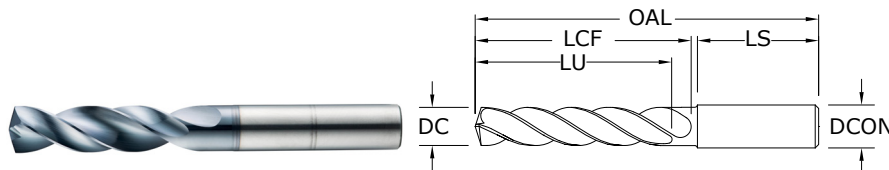

135 5xD

FRACTIONAL & METRIC SERIES

- 4-margin design improves accuracy and surface finish along with increased strength for aggressive drilling
- Specialized self-centering notched point eliminates the need for spot drilling decreasing thrust and deflection
- Engineered edge protection improves edge strength and reduces edge fatigue allowing for increased feed rates
- Recommended for materials ≤ 56 HRC (≤ 577 Bhn)

inch & mm								EDP NO.
DECIMAL DC	METRIC DC	FRACTIONAL/ LETTER/WIRE DC	SHANK DIAMETER DCON	OVERALL LENGTH OAL	FLUTE LENGTH LCF	USABLE LENGTH LU	SHANK LENGTH LS	Ti-NAMITE-A (AITiN)
0.0156	0,396 mm	1/64	1/8	1 1/2	5/32	1/8	1	52300*
0.0312	0,792 mm	1/32	1/8	1 1/2	5/16	17/64	1	52301*
0.0469	1,191 mm	3/64	1/8	1 1/2	25/64	21/64	1	52302*
0.0492	1,250 mm		3,0	38,0	10,0	8,0	25,0	64520*
0.0571	1,450 mm		3,0	38,0	10,0	8,0	25,0	64521*
0.0595	1,511 mm	#53	1/8	1-1/2	25/64	5/16	1	64522*
0.0625	1,588 mm	1/16	1/8	2	15/32	3/8	1-1/4	52303*
0.0630	1,600 mm		3,0	50,0	12,0	10,0	32,0	64523*
0.0689	1,750 mm		3,0	50,0	12,0	9,0	32,0	64524*
0.0700	1,778 mm	#50	1/8	2	15/32	23/64	1-1/4	64525*
0.0781	1,984 mm	5/64	1/8	2	35/64	7/16	1-1/4	52304*
0.0785	1,994 mm	#47	1/8	2	35/64	7/16	1-1/4	64526*
0.0807	2,050 mm		3,0	50,0	14,0	11,0	32,0	64527*
0.0810	2,057 mm	#46	1/8	2	35/64	27/64	1-1/4	64528*
0.0890	2,261 mm	#43	1/8	2	19/32	15/32	1-1/4	64529*
0.0935	2,375 mm	#42	1/8	2	5/8	31/64	1-1/4	64530*
0.0938	2,383 mm	3/32	1/8	2	5/8	31/64	1-1/4	52305
0.0980	2,489 mm	#40	1/8	2	43/64	17/32	1-1/4	52306
0.0984	2,500 mm		3,0	50,0	17,0	13,0	32,0	64531
0.0995	2,527 mm	#39	1/8	2	43/64	17/32	1-1/4	52307
0.1015	2,578 mm	#38	1/8	2	43/64	17/32	1-1/4	52308
0.1040	2,642 mm	#37	1/8	2	45/64	35/64	1-1/4	52309
0.1065	2,705 mm	#36	1/8	2	45/64	35/64	1-1/4	52310
0.1094	2,779 mm	7/64	1/8	2	3/4	19/32	1-1/4	52311
0.1100	2,794 mm	#35	1/8	2	3/4	19/32	1-1/4	52312
0.1110	2,819 mm	#34	1/8	2	3/4	19/32	1-1/4	52313
0.1130	2,870 mm	#33	1/8	2	3/4	19/32	1-1/4	52314
0.1142	2,900 mm		3,0	50,0	19,0	15,0	32,0	64532
0.1160	2,946 mm	#32	1/8	2	3/4	37/64	1-1/4	52315
0.1181	3,000 mm		6,0	66,0	28,0	24,0	36,0	64100
0.1200	3,048 mm	#31	1/8	2	3/4	37/64	1-1/4	52316
0.1220	3,100 mm		6,0	66,0	28,0	23,0	36,0	64101
0.1250	3,175 mm	1/8	1/4	3	1	13/16	1-7/16	51580
0.1260	3,200 mm		6,0	66,0	28,0	23,0	36,0	64102
0.1285	3,264 mm	#30	1/4	3	1	13/16	1-7/16	51581
0.1299	3,300 mm		6,0	66,0	28,0	23,0	36,0	64103
0.1339	3,400 mm		6,0	66,0	28,0	23,0	36,0	64104
0.1360	3,454 mm	#29	1/4	3	1	51/64	1-7/16	51582

*Single Margin

continued on next page

TOLERANCES (inch)

- $\leq .1181$ DIAMETER**
DC = $+0.0008/+0.0047$
DCON = h_6
- $>.1181-.2362$ DIAMETER**
DC = $+0.0016/+0.0063$
DCON = h_6
- $>.2362-.3937$ DIAMETER**
DC = $+0.0024/+0.0083$
DCON = h_6
- $>.3937-.7087$ DIAMETER**
DC = $+0.0028/+0.0098$
DCON = h_6
- $>.7087-1.1811$ DIAMETER**
DC = $+0.0031/+0.0114$
DCON = h_6

TOLERANCES (mm)

- ≤ 3 DIAMETER**
DC = $+0,002/+0,012$
DCON = h_6
- $>3-6$ DIAMETER**
DC = $+0,004/+0,016$
DCON = h_6
- $>6-10$ DIAMETER**
DC = $+0,006/+0,021$
DCON = h_6
- $>10-18$ DIAMETER**
DC = $+0,007/+0,025$
DCON = h_6
- $>18-30$ DIAMETER**
DC = $+0,008/+0,029$
DCON = h_6

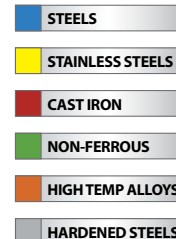

For patent information visit www.ksptpatents.com



FRACTIONAL & METRIC Series 135

135 5xD

FRACTIONAL & METRIC SERIES

CONTINUED

DECIMAL DC	METRIC DC	inch & mm						EDP NO.
		FRACTIONAL/ LETTER/WIRE DC	SHANK DIAMETER DCON	OVERALL LENGTH OAL	FLUTE LENGTH LCF	USABLE LENGTH LU	SHANK LENGTH LS	Ti-NAMITE-A (AITiN)
0.1378	3,500 mm		6,0	66,0	28,0	23,0	36,0	64105
0.1405	3,569 mm	#28	1/4	3	1	51/64	1- 7/16	52317
0.1406	3,571 mm	9/64	1/4	3	1	51/64	1-7/16	51583
0.1417	3,600 mm		6,0	66,0	28,0	23,0	36,0	64106
0.1440	3,658 mm	#27	1/4	3	1	51/64	1-7/16	52318
0.1457	3,700 mm		6,0	66,0	28,0	22,0	36,0	64107
0.1470	3,734 mm	#26	1/4	3	1	25/32	1-7/16	52319
0.1495	3,797 mm	#25	1/4	3-1/4	1-1/4	1-1/32	1-7/16	51584
0.1496	3,800 mm		6,0	74,0	36,0	30,0	36,0	64108
0.1520	3,861 mm	#24	1/4	3-1/4	1-1/4	1-1/32	1-7/16	52321
0.1535	3,900 mm		6,0	74,0	36,0	30,0	36,0	64109
0.1540	3,912 mm	#23	1/4	3-1/4	1-1/4	1-1/32	1-7/16	52322
0.1562	3,967 mm	5/32	1/4	3-1/4	1-1/4	1-1/64	1-7/16	51585
0.1570	3,988 mm	#22	1/4	3-1/4	1-1/4	1-1/64	1-7/16	52323
0.1575	4,000 mm		6,0	74,0	36,0	30,0	36,0	64110
0.1590	4,039 mm	#21	1/4	3-1/4	1-1/4	1-1/64	1-7/16	51586
0.1610	4,089 mm	#20	1/4	3-1/4	1-1/4	1	1-7/16	51587
0.1614	4,100 mm		6,0	74,0	36,0	30,0	36,0	64111
0.1654	4,200 mm		6,0	74,0	36,0	30,0	36,0	64112
0.1660	4,216 mm	#19	1/4	3-1/4	1-1/4	1	1-7/16	52324
0.1693	4,300 mm		6,0	74,0	36,0	30,0	36,0	64113
0.1695	4,305 mm	#18	1/4	3-1/4	1-1/4	1	1-7/16	52325
0.1719	4,366 mm	11/64	1/4	3-1/4	1-1/4	1	1-7/16	51588
0.1730	4,394 mm	#17	1/4	3-1/4	1-1/4	1	1-7/16	52326
0.1732	4,400 mm		6,0	74,0	36,0	29,0	36,0	64114
0.1772	4,500 mm		6,0	74,0	36,0	29,0	36,0	64115
0.1800	4,572 mm	#15	1/4	3-1/4	1-1/4	63/64	1-7/16	52327
0.1811	4,600 mm		6,0	74,0	36,0	29,0	36,0	64116
0.1820	4,623 mm	#14	1/4	3-1/4	1-1/4	63/64	1-7/16	52328
0.1850	4,699 mm	#13	1/4	3-1/4	1-1/4	63/64	1-7/16	52329
0.1850	4,699 mm	#13	6,0	74,0	36,0	29,0	36,0	64117
0.1875	4,763 mm	3/16	1/4	3-1/4	1-3/4	1-15/32	1-7/16	51589
0.1890	4,801 mm	#12	1/4	3-1/4	1-3/4	1-15/32	1-7/16	52330
0.1890	4,801 mm	#12	6,0	82,0	44,0	37,0	36,0	64118
0.1929	4,900 mm		6,0	82,0	44,0	37,0	36,0	64119
0.1935	4,915 mm	#10	1/4	3-1/4	1-3/4	1-15/32	1-7/16	52331
0.1960	4,978 mm	#9	1/4	3-1/4	1-3/4	1-15/32	1-7/16	52332
0.1969	5,000 mm		6,0	82,0	44,0	36,0	36,0	64120
0.1990	5,055 mm	#8	1/4	3-1/4	1-3/4	1-15/32	1-7/16	52333
0.2008	5,100 mm		6,0	82,0	44,0	36,0	36,0	64121
0.2010	5,105 mm	#7	1/4	3-1/4	1-3/4	1-29/64	1-7/16	51506
0.2031	5,159 mm	13/64	1/4	3-1/4	1-3/4	1-29/64	1-7/16	51507
0.2040	5,182 mm	#6	1/4	3 1/4	1 3/4	1-29/64	1 7/16	52334
0.2047	5,200 mm		6,0	82,0	44,0	36,0	36,0	64122

continued on next page

Series 135 5xD | Fractional & Metric

FRACTIONAL & METRIC Series 135

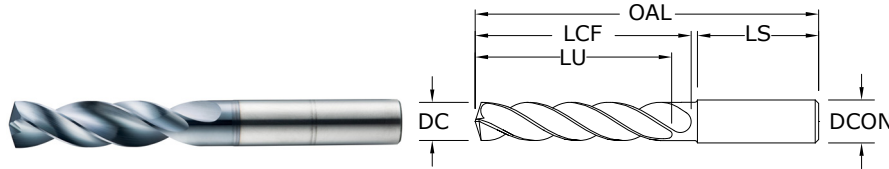

135 5xD FRACTIONAL & METRIC SERIES

- 4-margin design improves accuracy and surface finish along with increased strength for aggressive drilling
- Specialized self-centering notched point eliminates the need for spot drilling decreasing thrust and deflection
- Engineered edge protection improves edge strength and reduces edge fatigue allowing for increased feed rates
- Recommended for materials ≤ 56 HRc (≤ 577 Bhn)

inch & mm								EDP NO.
DECIMAL DC	METRIC DC	FRACTIONAL/ LETTER/WIRE DC	SHANK DIAMETER DCON	OVERALL LENGTH OAL	FLUTE LENGTH LCF	USABLE LENGTH LU	SHANK LENGTH LS	Ti-NAMITE-A (AITiN)
0.2055	5,220 mm	#5	1/4	3-1/4	1-3/4	1-29/64	1-7/16	51590
0.2067	5,250 mm		6,0	82,0	44,0	36,0	36,0	64123
0.2087	5,300 mm		6,0	82,0	44,0	36,0	36,0	64124
0.2090	5,309 mm	#4	1/4	3-1/4	1-3/4	1-7/16	1-7/16	51508
0.2126	5,400 mm		6,0	82,0	44,0	36,0	36,0	64125
0.2130	5,410 mm	#3	1/4	3-1/4	1-3/4	1-7/16	1-7/16	51509
0.2165	5,500 mm		6,0	82,0	44,0	36,0	36,0	64126
0.2188	5,558 mm	7/32	1/4	3-1/4	1-3/4	1-27/64	1-7/16	51510
0.2205	5,600 mm		6,0	82,0	44,0	36,0	36,0	64127
0.2210	5,613 mm	#2	1/4	3-1/4	1-3/4	1-27/64	1-7/16	52335
0.2244	5,700 mm		6,0	82,0	44,0	35,0	36,0	64128
0.2280	5,791 mm	#1	1/4	3-1/4	1-3/4	1-13/32	1-7/16	52336
0.2283	5,800 mm		6,0	82,0	44,0	35,0	36,0	64129
0.2323	5,900 mm		6,0	82,0	44,0	35,0	36,0	64130
0.2340	5,944 mm	A	1/4	3-1/4	1-3/4	1-13/32	1-7/16	52337
0.2344	5,954 mm	15/64	1/4	3-1/4	1-3/4	1-13/32	1-7/16	51591
0.2362	6,000 mm		6,0	82,0	44,0	35,0	36,0	64131
0.2380	6,045 mm	B	1/4	3 5/8	2-5/64	1-13/32	1-7/16	52338
0.2402	6,100 mm		8,0	91,0	53,0	44,0	36,0	64132
0.2420	6,147 mm	C	1/4	3 5/8	2-5/64	1-13/32	1-7/16	52339
0.2441	6,200 mm		8,0	91,0	53,0	44,0	36,0	64133
0.2460	6,248 mm	D	1/4	3 5/8	2-5/64	1-13/32	1-7/16	52340
0.2461	6,250 mm		8,0	91,0	53,0	44,0	36,0	64134
0.2480	6,300 mm		8,0	91,0	53,0	44,0	36,0	64135
0.2500	6,350 mm	1/4 E #0	1/4	3-5/8	2-5/64	1-45/64	1-7/16	51511
0.2520	6,400 mm		8,0	91,0	53,0	43,0	36,0	64136
0.2559	6,500 mm		8,0	91,0	53,0	43,0	36,0	64137
0.2570	6,528 mm	F	5/16	3-5/8	2-5/64	1-45/64	1-7/16	51512
0.2598	6,600 mm		8,0	91,0	53,0	43,0	36,0	64138
0.2610	6,629 mm	G	5/16	3 5/8	2 5/64	1-11/16	1 7/16	52341
0.2638	6,700 mm		8,0	91,0	53,0	43,0	36,0	64139
0.2656	6,746 mm	17/64	5/16	3-5/8	2-5/64	1-11/16	1-7/16	51513
0.2660	6,756 mm	H	5/16	3-5/8	2-5/64	1-11/16	1-7/16	52342
0.2677	6,800 mm		8,0	91,0	53,0	43,0	36,0	64140
0.2717	6,900 mm		8,0	91,0	53,0	43,0	36,0	64141
0.2720	6,909 mm	I	5/16	3-5/8	2-5/64	1-43/64	1-7/16	51514
0.2756	7,000 mm		8,0	91,0	53,0	42,0	36,0	64142
0.2770	7,036 mm	J	5/16	3 5/8	2-5/64	1-43/64	1-7/16	52343

TOLERANCES (inch)

- ≤.1181 DIAMETER**
DC = +.00008/+0.00047
DCON = h₆
- >.1181-.2362 DIAMETER**
DC = +.00016/+0.00063
DCON = h₆
- >.2362-.3937 DIAMETER**
DC = +.00024/+0.00083
DCON = h₆
- >.3937-.7087 DIAMETER**
DC = +.00028/+0.00098
DCON = h₆
- >.7087-1.1811 DIAMETER**
DC = +.00031/+0.00114
DCON = h₆

TOLERANCES (mm)

- ≤3 DIAMETER**
DC = +0,002/+0,012
DCON = h₆
- >3-6 DIAMETER**
DC = +0,004/+0,016
DCON = h₆
- >6-10 DIAMETER**
DC = +0,006/+0,021
DCON = h₆
- >10-18 DIAMETER**
DC = +0,007/+0,025
DCON = h₆
- >18-30 DIAMETER**
DC = +0,008/+0,029
DCON = h₆

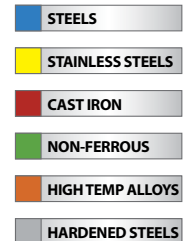

For patent information visit www.kspatents.com

continued on next page



FRACTIONAL & METRIC Series 135

135 5xD

FRACTIONAL & METRIC SERIES

CONTINUED

DECIMAL DC	METRIC DC	FRACTIONAL/ LETTER/WIRE DC	inch & mm					SHANK LENGTH LS	EDP NO. Ti-NAMITE-A (AITiN)
			SHANK DIAMETER DCON	OVERALL LENGTH OAL	FLUTE LENGTH LCF	USABLE LENGTH LU	SHANK LENGTH LS		
0.2795	7,100 mm		8,0	91,0	53,0	42,0	36,0	64143	
0.2810	7,137 mm	K	5/16	3 5/8	2-5/64	1-21/32	1-7/16	52344	
0.2812	7,142 mm	9/32	5/16	3-5/8	2-5/64	1-21/32	1-7/16	51515	
0.2835	7,200 mm		8,0	91,0	53,0	42,0	36,0	64144	
0.2854	7,250 mm		8,0	91,0	53,0	42,0	36,0	64145	
0.2874	7,300 mm		8,0	91,0	53,0	42,0	36,0	64146	
0.2900	7,366 mm	L	5/16	3-5/8	2-5/64	1-41/64	1-7/16	52345	
0.2913	7,400 mm		8,0	91,0	53,0	42,0	36,0	64147	
0.2950	7,493 mm	M	5/16	3-5/8	2-5/64	1-41/64	1-7/16	52346	
0.2953	7,500 mm		8,0	91,0	53,0	42,0	36,0	64148	
0.2969	7,541 mm	19/64	5/16	3-5/8	2-5/64	1-41/64	1-7/16	51516	
0.2992	7,600 mm		8,0	91,0	53,0	42,0	36,0	64149	
0.3020	7,671 mm	N	5/16	3-5/8	2-5/64	1-5/8	1-7/16	52347	
0.3031	7,700 mm		8,0	91,0	53,0	41,0	36,0	64150	
0.3071	7,800 mm		8,0	91,0	53,0	41,0	36,0	64151	
0.3110	7,900 mm		8,0	91,0	53,0	41,0	36,0	64152	
0.3125	7,938 mm	5/16	5/16	3-5/8	2-5/64	1-39/64	1-7/16	51517	
0.3150	8,000 mm		8,0	91,0	53,0	41,0	36,0	64153	
0.3160	8,026 mm	O	3/8	4	2-13/32	1-15/16	1-9/16	52348	
0.3189	8,100 mm		10,0	103,0	61,0	49,0	40,0	64154	
0.3228	8,200 mm		10,0	103,0	61,0	49,0	40,0	64155	
0.3230	8,204 mm	P	3/8	4	2-13/32	1-59/64	1-9/16	51518	
0.3268	8,300 mm		10,0	103,0	61,0	49,0	40,0	64156	
0.3281	8,334 mm	21/64	3/8	4	2-13/32	1-59/64	1-9/16	51519	
0.3307	8,400 mm		10,0	103,0	61,0	48,0	40,0	64157	
0.3320	8,433 mm	Q	3/8	4	2-13/32	1-59/64	1-9/16	51520	
0.3346	8,500 mm		10,0	103,0	61,0	48,0	40,0	64158	
0.3386	8,600 mm		10,0	103,0	61,0	48,0	40,0	64159	
0.3390	8,611 mm	R	3/8	4	2-13/32	1-29/32	1-9/16	52349	
0.3425	8,700 mm		10,0	103,0	61,0	48,0	40,0	64160	
0.3438	8,733 mm	11/32	3/8	4	2-13/32	1-57/64	1-9/16	51521	
0.3465	8,800 mm		10,0	103,0	61,0	48,0	40,0	64161	
0.3480	8,839 mm	S	3/8	4	2-13/32	1-57/64	1-9/16	51522	
0.3504	8,900 mm		10,0	103,0	61,0	48,0	40,0	64162	
0.3543	9,000 mm		10,0	103,0	61,0	48,0	40,0	64163	
0.3580	9,093 mm	T	3/8	4	2 13/32	1-7/8	1 9/16	52350	
0.3583	9,100 mm		10,0	103,0	61,0	47,0	40,0	64164	
0.3594	9,129 mm	23/64	3/8	4	2-13/32	1-7/8	1-9/16	51523	
0.3622	9,200 mm		10,0	103,0	61,0	47,0	40,0	64165	
0.3642	9,250 mm		10,0	103,0	61,0	47,0	40,0	64166	
0.3661	9,300 mm		10,0	103,0	61,0	47,0	40,0	64167	
0.3680	9,347 mm	U	3/8	4	2-13/32	1-55/64	1-9/16	51524	
0.3701	9,400 mm		10,0	103,0	61,0	47,0	40,0	64168	
0.3740	9,500 mm		10,0	103,0	61,0	47,0	40,0	64169	

continued on next page

Series 135 5xD | Fractional & Metric

FRACTIONAL & METRIC Series 135

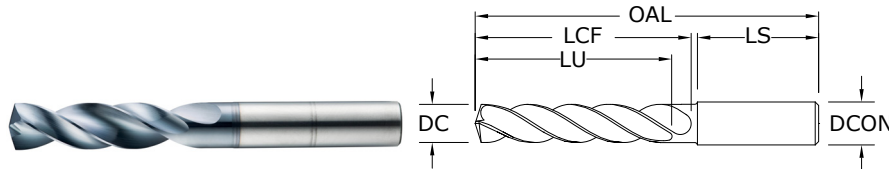

135 5xD

FRACTIONAL & METRIC SERIES

- 4-margin design improves accuracy and surface finish along with increased strength for aggressive drilling
- Specialized self-centering notched point eliminates the need for spot drilling decreasing thrust and deflection
- Engineered edge protection improves edge strength and reduces edge fatigue allowing for increased feed rates
- Recommended for materials ≤ 56 HRc (≤ 577 Bhn)

inch & mm								EDP NO.
DECIMAL DC	METRIC DC	FRACTIONAL/ LETTER/WIRE DC	SHANK DIAMETER DCON	OVERALL LENGTH OAL	FLUTE LENGTH LCF	USABLE LENGTH LU	SHANK LENGTH LS	Ti-NAMITE-A (AITiN)
0.3750	9,525 mm	3/8	3/8	4	2-13/32	1-27/32	1-9/16	51525
0.3770	9,576 mm	V	1/2	4	2-13/32	1-27/32	1-9/16	52351
0.3780	9,600 mm		10,0	103,0	61,0	47,0	40,0	64170
0.3819	9,700 mm		10,0	103,0	61,0	46,0	40,0	64171
0.3858	9,800 mm		10,0	103,0	61,0	46,0	40,0	64172
0.3860	9,804 mm	W	1/2	4	2-13/32	1-53/64	1-9/16	51526
0.3898	9,900 mm		10,0	103,0	61,0	46,0	40,0	64173
0.3906	9,921 mm	25/64	1/2	4	2-13/32	1-53/64	1-9/16	51527
0.3937	10,000 mm		10,0	103,0	61,0	46,0	40,0	64174
0.3970	10,084 mm	X	1/2	4-11/16	2-3/4	2-5/32	1-49/64	52352
0.3976	10,100 mm		12,0	118,0	71,0	56,0	45,0	64175
0.4016	10,200 mm		12,0	118,0	71,0	56,0	45,0	64176
0.4040	10,262 mm	Y	1/2	4-11/16	2-3/4	2-5/32	1-49/64	52353
0.4055	10,300 mm		12,0	118,0	71,0	56,0	45,0	64177
0.4062	10,317 mm	13/32	1/2	4-11/16	2-3/4	2-9/64	1-49/64	51528
0.4095	10,400 mm		12,0	118,0	71,0	55,0	45,0	64178
0.4130	10,490 mm	Z	1/2	4-11/16	2-3/4	2-9/64	1-49/64	52354
0.4134	10,500 mm		12,0	118,0	71,0	55,0	45,0	64179
0.4173	10,600 mm		12,0	118,0	71,0	55,0	45,0	64180
0.4213	10,700 mm		12,0	118,0	71,0	55,0	45,0	64181
0.4219	10,716 mm	27/64	1/2	4-11/16	2-3/4	2-1/8	1-49/64	51529
0.4252	10,800 mm		12,0	118,0	71,0	55,0	45,0	64182
0.4291	10,900 mm		12,0	118,0	71,0	55,0	45,0	64183
0.4331	11,000 mm		12,0	118,0	71,0	54,0	45,0	64184
0.4370	11,100 mm		12,0	118,0	71,0	54,0	45,0	64185
0.4375	11,113 mm	7/16	1/2	4-11/16	2-3/4	2-3/32	1-49/64	51530
0.4409	11,200 mm		12,0	118,0	71,0	54,0	45,0	64186
0.4429	11,250 mm		12,0	118,0	71,0	54,0	45,0	64187
0.4449	11,300 mm		12,0	118,0	71,0	54,0	45,0	64188
0.4488	11,400 mm		12,0	118,0	71,0	54,0	45,0	64189
0.4528	11,500 mm		12,0	118,0	71,0	54,0	45,0	64190
0.4531	11,509 mm	29/64	1/2	4-11/16	2-3/4	2-5/64	1-49/64	51531
0.4567	11,600 mm		12,0	118,0	71,0	54,0	45,0	64191
0.4606	11,700 mm		12,0	118,0	71,0	53,0	45,0	64192
0.4646	11,800 mm		12,0	118,0	71,0	53,0	45,0	64193
0.4685	11,900 mm		12,0	118,0	71,0	53,0	45,0	64194
0.4688	11,908 mm	15/32	1/2	4-11/16	2-3/4	2-3/64	1-49/64	51532
0.4724	12,000 mm		12,0	118,0	71,0	53,0	45,0	64195

TOLERANCES (inch)

- ≤.1181 DIAMETER**
DC = +.00008/+-.00047
DCON = h_6
- >.1181-.2362 DIAMETER**
DC = +.00016/+-.00063
DCON = h_6
- >.2362-.3937 DIAMETER**
DC = +.00024/+-.00083
DCON = h_6
- >.3937-.7087 DIAMETER**
DC = +.00028/+-.00098
DCON = h_6
- >.7087-1.1811 DIAMETER**
DC = +.00031/+-.00114
DCON = h_6

TOLERANCES (mm)

- ≤3 DIAMETER**
DC = +0,002/+0,012
DCON = h_6
- >3-6 DIAMETER**
DC = +0,004/+0,016
DCON = h_6
- >6-10 DIAMETER**
DC = +0,006/+0,021
DCON = h_6
- >10-18 DIAMETER**
DC = +0,007/+0,025
DCON = h_6
- >18-30 DIAMETER**
DC = +0,008/+0,029
DCON = h_6

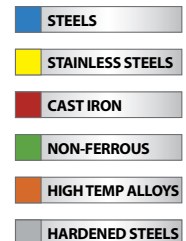

For patent information visit www.ksptpatents.com

continued on next page



FRACTIONAL & METRIC
Series 135

135 5xD

FRACTIONAL & METRIC SERIES

CONTINUED

DECIMAL DC	METRIC DC	inch & mm						EDP NO.
		FRACTIONAL/ LETTER/WIRE DC	SHANK DIAMETER DCON	OVERALL LENGTH OAL	FLUTE LENGTH LCF	USABLE LENGTH LU	SHANK LENGTH LS	Ti-NAMITE-A (AITiN)
0.4844	12,304 mm	31/64	1/2	4-7/8	3-1/32	1-5/16	1-49/64	51533
0.4921	12,500 mm		14,0	124,0	77,0	58,0	45,0	64196
0.5000	12,700 mm	1/2	1/2	4-7/8	3-1/32	2-9/32	1-49/64	51534
0.5039	12,800 mm		14,0	124,0	77,0	58,0	45,0	64197
0.5118	13,000 mm		14,0	124,0	77,0	58,0	45,0	64198
0.5156	13,096 mm	33/64	5/8	4-7/8	3-1/32	2-17/64	1-49/64	51535
0.5312	13,492 mm	17/32	5/8	4-7/8	3-1/32	2-15/64	1-49/64	51536
0.5315	13,500 mm		14,0	124,0	77,0	57,0	45,0	64199
0.5469	13,8 mm	35/64	5/8	4-7/8	3-1/32	2-7/32	1-49/64	51537
0.5512	14,000 mm		14,0	124,0	77,0	56,0	45,0	64200
0.5625	14,288 mm	9/16	5/8	5-1/4	3-1/4	2-13/32	1-57/64	51538
0.5709	14,500 mm		16,0	133,0	83,0	61,0	48,0	64201
0.5781	14,684 mm	37/64	5/8	5-1/4	3-1/4	2-25/64	1-57/64	51539
0.5906	15,000 mm		16,0	133,0	83,0	60,0	48,0	64202
0.5938	15,083 mm	19/32	5/8	5-1/4	3-1/4	2-23/64	1-57/64	51592
0.6094	15,479 mm	39/64	5/8	5-1/4	3-1/4	2-11/32	1-57/64	51593
0.6102	15,500 mm		16,0	133,0	83,0	60,0	48,0	64203
0.6250	15,875 mm	5/8	5/8	5-1/4	3-1/4	2-5/16	1-57/64	51540
0.6299	16,000 mm		16,0	133,0	83,0	59,0	48,0	64204
0.6406	16,271 mm	41/64	3/4	5-5/8	3-5/8	2-43/64	1-57/64	51594
0.6496	16,500 mm		18,0	143,0	93,0	68,0	48,0	64205
0.6562	16,667 mm	21/32	3/4	5-5/8	3-5/8	2-41/64	1-57/64	51541
0.6693	17,000 mm		18,0	143,0	93,0	67,0	48,0	64206
0.6719	17,066 mm	43/64	3/4	5-5/8	3-5/8	2-5/8	1-57/64	51595
0.6875	17,463 mm	11/16	3/4	5-5/8	3-5/8	2-19/32	1-57/64	51542
0.6890	17,500 mm		18,0	143,0	93,0	67,0	48,0	64207
0.7031	17,859 mm	45/64	3/4	5-5/8	3-5/8	2-37/64	1-57/64	51543
0.7087	18,000 mm		18,0	143,0	93,0	66,0	48,0	64208
0.7188	18,258 mm	23/32	3/4	6	4	2-59/64	1-31/32	51596
0.7283	18,500 mm		20,0	153,0	101,0	73,0	50,0	64209
0.7344	18,654 mm	47/64	3/4	6	4	2-29/32	1-31/32	51544
0.7480	19,000 mm		20,0	153,0	101,0	73,0	50,0	64210
0.7500	19,050 mm	3/4	3/4	6	4	2-7/8	1-31/32	51545
0.7656	19,446 mm	49/64	7/8	6	4	2-55/64	1-31/32	52355
0.7677	19,500 mm		20,0	153,0	101,0	72,0	50,0	64211
0.7812	19,842 mm	25/32	7/8	6	4	2-55/64	1-31/32	52356
0.7874	20,000 mm		20,0	153,0	101,0	71,0	50,0	64212
0.7969	20,241 mm	51/64	7/8	6	4	2-13/16	1-31/32	52357
0.8071	20,500 mm		22,0	153,0	101,0	70,0	50,0	64533
0.8125	20,638 mm	13/16	7/8	6-1/2	4-1/2	3-3/32	1-31/32	52358
0.8268	21,000 mm		22,0	153,0	101,0	69,0	50,0	64534
0.8661	22,000 mm		22,0	178,0	127,0	94,0	50,0	64535
0.8750	22,225 mm	7/8	7/8	6-1/2	4-1/2	3-3/16	1-31/32	52359
0.9219	23,416 mm	59/64	1	7	5	3-5/8	2-1/8	52360

Series 135 5xD | Fractional & Metric

FRACTIONAL
Series 135



Series 135 | Speed & Feed Recommendations

Series 135 5D Fractional	Hardness	Vc (sfm)	DC • in								
			1/32	1/8	1/4	3/8	1/2	5/8	7/8		
CARBON STEELS 1018, 1040, 1080, 1090, 10L50, 1140, 1212, 12L15, 1525, 1536	≤ 175 Bhn or ≤ 7 HRc	345 (276-414)	RPM	42173	10543	5272	3514	2636	2109	1506	
			Fr	0.0010	0.0040	0.0080	0.0120	0.0159	0.0199	0.0279	
			Feed (ipm)	42.0	42.0	42.0	42.0	42.0	42.0	42.0	
	≤ 275 Bhn or ≤ 28 HRc	310 (248-372)	RPM	37894	9474	4737	3158	2368	1895	1353	
			Fr	0.0009	0.0036	0.0072	0.0108	0.0144	0.0179	0.0251	
			Feed (ipm)	34.0	34.0	34.0	34.0	34.0	34.0	34.0	
	≤ 425 Bhn or ≤ 45 HRc	180 (144-216)	RPM	22003	5501	2750	1834	1375	1100	786	
			Fr	0.0007	0.0030	0.0060	0.0090	0.0120	0.0150	0.0210	
			Feed (ipm)	16.5	16.5	16.5	16.5	16.5	16.5	16.5	
	ALLOY STEELS 4140, 4150, 4320, 5120, 5150, 8630, 86L20, 50100	≤ 275 Bhn or ≤ 28 HRc	270 (216-324)	RPM	33005	8251	4126	2750	2063	1650	1179
				Fr	0.0008	0.0030	0.0061	0.0091	0.0121	0.0151	0.0212
				Feed (ipm)	25.0	25.0	25.0	25.0	25.0	25.0	25.0
≤ 375 Bhn or ≤ 40 HRc		165 (132-198)	RPM	20170	5042	2521	1681	1261	1008	720	
			Fr	0.0006	0.0026	0.0052	0.0077	0.0103	0.0129	0.0180	
			Feed (ipm)	13.0	13.0	13.0	13.0	13.0	13.0	13.0	
≤ 425 Bhn or ≤ 45 HRc		115 (92-138)	RPM	14058	3514	1757	1171	879	703	502	
			Fr	0.0004	0.0018	0.0035	0.0053	0.0071	0.0088	0.0123	
			Feed (ipm)	6.2	6.2	6.2	6.2	6.2	6.2	6.2	
TOOL STEELS A2, D2, H13, L2, M2, P20, S7, T15, W2		≤ 200 Bhn or ≤ 13 HRc	120 (96-144)	RPM	14669	3667	1834	1222	917	733	524
				Fr	0.0006	0.0026	0.0051	0.0077	0.0103	0.0128	0.0179
				Feed (ipm)	9.4	9.4	9.4	9.4	9.4	9.4	9.4
	≤ 375 Bhn or ≤ 40 HRc	80 (64-96)	RPM	9779	2445	1222	815	611	489	349	
			Fr	0.0003	0.0012	0.0024	0.0036	0.0047	0.0059	0.0083	
			Feed (ipm)	2.9	2.9	2.9	2.9	2.9	2.9	2.9	
STAINLESS STEELS (FREE MACHINING) 303, 416, 420F, 430F, 440F	≤ 185 Bhn or ≤ 9 HRc	250 (200-300)	RPM	30560	7640	3820	2547	1910	1528	1091	
			Fr	0.0006	0.0026	0.0051	0.0077	0.0102	0.0128	0.0179	
			Feed (ipm)	19.5	19.5	19.5	19.5	19.5	19.5	19.5	
	≤ 275 Bhn or ≤ 28 HRc	150 (120-180)	RPM	18336	4584	2292	1528	1146	917	655	
			Fr	0.0005	0.0020	0.0039	0.0059	0.0079	0.0098	0.0137	
			Feed (ipm)	9.0	9.0	9.0	9.0	9.0	9.0	9.0	
	STAINLESS STEELS (DIFFICULT) 304, 316, 321, 13-8 PH, 15-5PH, 17-4 PH, Custom 450	≤ 275 Bhn or ≤ 28 HRc	80 (64-96)	RPM	9779	2445	1222	815	611	489	349
				Fr	0.0005	0.0020	0.0039	0.0059	0.0079	0.0098	0.0137
				Feed (ipm)	4.8	4.8	4.8	4.8	4.8	4.8	4.8
		≤ 375 Bhn or ≤ 40 HRc	55 (44-66)	RPM	6723	1681	840	560	420	336	240
				Fr	0.0004	0.0018	0.0036	0.0054	0.0071	0.0089	0.0125
				Feed (ipm)	3.0	3.0	3.0	3.0	3.0	3.0	3.0
CAST IRONS Gray, Malleable, Ductile	≤ 220 Bhn or ≤ 19 HRc	300 (240-360)	RPM	36672	9168	4584	3056	2292	1834	1310	
			Fr	0.0011	0.0045	0.0089	0.0134	0.0179	0.0224	0.0313	
			Feed (ipm)	41.0	41.0	41.0	41.0	41.0	41.0	41.0	
	≤ 260 Bhn or ≤ 26 HRc	265 (212-318)	RPM	32394	8098	4049	2699	2025	1620	1157	
			Fr	0.0011	0.0046	0.0091	0.0137	0.0183	0.0228	0.0320	
			Feed (ipm)	37.0	37.0	37.0	37.0	37.0	37.0	37.0	

continued on next page

Series 135 5D Fractional	Hardness	Vc (sfm)	DC • in							
			1/32	1/8	1/4	3/8	1/2	5/8	7/8	
N	ALUMINUM ALLOYS 2017, 2024, 356, 6061, 7075	≤ 80 Bhn or ≤ 47 HRb (508-762)	RPM	77622	19406	9703	6469	4851	3881	2772
			Fr	0.0012	0.0049	0.0099	0.0148	0.0198	0.0247	0.0346
			Feed (ipm)	96.0	96.0	96.0	96.0	96.0	96.0	96.0
		≤ 150 Bhn or ≤ 88 HRc (432-648)	RPM	66010	16502	8251	5501	4126	3300	2357
			Fr	0.0012	0.0050	0.0099	0.0149	0.0199	0.0248	0.0348
			Feed (ipm)	82.0	82.0	82.0	82.0	82.0	82.0	82.0
	COPPER ALLOYS Alum Bronze, C110, Muntz Brass	≤ 140 Bhn or ≤ 3 HRc (360-540)	RPM	55008	13752	6876	4584	3438	2750	1965
			Fr	0.0005	0.0020	0.0040	0.0060	0.0080	0.0100	0.0140
			Feed (ipm)	27.5	27.5	27.5	27.5	27.5	27.5	27.5
		≤ 200 Bhn or ≤ 23 HRc (288-432)	RPM	44006	11002	5501	3667	2750	2200	1572
			Fr	0.0005	0.0020	0.0040	0.0060	0.0080	0.0100	0.0140
			Feed (ipm)	22.0	22.0	22.0	22.0	22.0	22.0	22.0
S	HIGH TEMP ALLOYS (Nickel , Cobalt, Iron Base) Inconel 601, 617, 625, Incoloy, Monel 400, Rene, Waspaloy	≤ 300 Bhn or ≤ 32 HRc (32-48)	RPM	4890	1222	611	407	306	244	175
			Fr	0.0002	0.0008	0.0016	0.0025	0.0033	0.0041	0.0057
			Feed (ipm)	1.0	1.0	1.0	1.0	1.0	1.0	1.0
		≤ 400 Bhn or ≤ 43 HRc (16-24)	RPM	2445	611	306	204	153	122	87
			Fr	0.0002	0.0007	0.0013	0.0020	0.0026	0.0033	0.0046
			Feed (ipm)	0.4	0.4	0.4	0.4	0.4	0.4	0.4
	TITANIUM ALLOYS Pure Titanium, Ti6Al4V, Ti6Al2Sn4Zr2Mo, Ti4Al4Mo2Sn0.5Si, Ti-6Al4V	≤ 275 Bhn or ≤ 28 HRc (84-126)	RPM	12835	3209	1604	1070	802	642	458
			Fr	0.0005	0.0018	0.0036	0.0054	0.0072	0.0090	0.0127
			Feed (ipm)	5.8	5.8	5.8	5.8	5.8	5.8	5.8
		≤ 350 Bhn or ≤ 38 HRc (64-96)	RPM	9779	2445	1222	815	611	489	349
			Fr	0.0004	0.0016	0.0032	0.0048	0.0064	0.0080	0.0112
			Feed (ipm)	3.9	3.9	3.9	3.9	3.9	3.9	3.9
≤ 440 Bhn or ≤ 47 HRc (34-50)	RPM	5134	1284	642	428	321	257	183		
	Fr	0.0003	0.0012	0.0025	0.0037	0.0050	0.0062	0.0087		
	Feed (ipm)	1.6	1.6	1.6	1.6	1.6	1.6	1.6		
H	TOOL STEELS A2, D2, H13, L2, M2, P20, S7, T15, W2	≤ 475 Bhn or ≤ 50 HRc (56-84)	RPM	8557	2139	1070	713	535	428	306
			Fr	0.0002	0.0008	0.0016	0.0024	0.0032	0.0040	0.0056
			Feed (ipm)	1.7	1.7	1.7	1.7	1.7	1.7	1.7

Bhn (Brinell) HRc (Rockwell C) HRb (Rockwell B)
 $rpm = Vc \times 3.82 / DC$
 $ipm = Fr \times rpm$
 reduce speed and feed for materials harder than listed
 refer to the SGS Tool Wizard® for complete technical information (www.kyocera-sgstool.com)

METRIC
Series 135



Series 135 | Speed & Feed Recommendations

Series 135M 5D Metric	Hardness	Vc (m/min)	DC • mm									
			1.5	3	6	8	10	12	16	20		
CARBON STEELS 1018, 1040, 1080, 1090, 10L50, 1140, 1212, 12L15, 1525, 1536	≤ 175 Bhn or ≤ 7 HRc	105	RPM	22297	11148	5574	4181	3344	2787	2090	1672	
		(84-126)	Fr	0.048	0.095	0.190	0.254	0.317	0.380	0.507	0.634	
			Feed (mm/min)	1060	1060	1060	1060	1060	1060	1060	1060	
	≤ 275 Bhn or ≤ 28 HRc	94	RPM	20035	10017	5009	3756	3005	2504	1878	1503	
		(76-113)	Fr	0.043	0.085	0.171	0.228	0.285	0.341	0.455	0.569	
			Feed (mm/min)	855	855	855	855	855	855	855	855	
	≤ 425 Bhn or ≤ 45 HRc	55	RPM	11633	5816	2908	2181	1745	1454	1091	872	
		(44-66)	Fr	0.036	0.071	0.143	0.190	0.238	0.285	0.381	0.476	
			Feed (mm/min)	415	415	415	415	415	415	415	415	
ALLOY STEELS 4140, 4150, 4320, 5120, 5150, 8630, 86L20, 50100	≤ 275 Bhn or ≤ 28 HRc	82	RPM	17449	8725	4362	3272	2617	2181	1636	1309	
		(66-99)	Fr	0.036	0.072	0.143	0.191	0.239	0.287	0.382	0.478	
			Feed (mm/min)	625	625	625	625	625	625	625	625	
	≤ 375 Bhn or ≤ 40 HRc	50	RPM	10664	5332	2666	1999	1600	1333	1000	800	
		(40-60)	Fr	0.031	0.062	0.124	0.165	0.206	0.248	0.330	0.413	
			Feed (mm/min)	330	330	330	330	330	330	330	330	
	≤ 425 Bhn or ≤ 45 HRc	35	RPM	7432	3716	1858	1394	1115	929	697	557	
		(28-42)	Fr	0.022	0.043	0.086	0.115	0.144	0.172	0.230	0.287	
			Feed (mm/min)	160	160	160	160	160	160	160	160	
TOOL STEELS A2, D2, H13, L2, M2, P20, S7, T15, W2	≤ 200 Bhn or ≤ 13 HRc	37	RPM	7755	3878	1939	1454	1163	969	727	582	
		(29-44)	Fr	0.031	0.062	0.124	0.165	0.206	0.248	0.330	0.413	
			Feed (mm/min)	240	240	240	240	240	240	240	240	
	≤ 375 Bhn or ≤ 40 HRc	24	RPM	5170	2585	1293	969	776	646	485	388	
		(20-29)	Fr	0.015	0.029	0.058	0.077	0.097	0.116	0.155	0.193	
			Feed (mm/min)	75	75	75	75	75	75	75	75	
	STAINLESS STEELS (FREE MACHINING) 303, 416, 420F, 430F, 440F	≤ 185 Bhn or ≤ 9 HRc	76	RPM	16157	8078	4039	3029	2424	2020	1515	1212
			(61-91)	Fr	0.031	0.061	0.123	0.163	0.204	0.245	0.327	0.408
				Feed (mm/min)	495	495	495	495	495	495	495	495
≤ 275 Bhn or ≤ 28 HRc		46	RPM	9694	4847	2424	1818	1454	1212	909	727	
		(37-55)	Fr	0.024	0.047	0.095	0.127	0.158	0.190	0.253	0.316	
			Feed (mm/min)	230	230	230	230	230	230	230	230	
STAINLESS STEELS (DIFFICULT) 304, 316, 321, 13-8 PH, 15-5PH, 17-4 PH, Custom 450		≤ 275 Bhn or ≤ 28 HRc	24	RPM	5170	2585	1293	969	776	646	485	388
			(20-29)	Fr	0.023	0.046	0.093	0.124	0.155	0.186	0.248	0.309
				Feed (mm/min)	120	120	120	120	120	120	120	120
	≤ 375 Bhn or ≤ 40 HRc	17	RPM	3555	1777	889	666	533	444	333	267	
		(13-20)	Fr	0.021	0.042	0.084	0.113	0.141	0.169	0.225	0.281	
			Feed (mm/min)	75	75	75	75	75	75	75	75	
	CAST IRONS Gray, Malleable, Ductile	≤ 220 Bhn or ≤ 19 HRc	91	RPM	19388	9694	4847	3635	2908	2424	1818	1454
			(73-110)	Fr	0.054	0.108	0.217	0.289	0.361	0.433	0.578	0.722
				Feed (mm/min)	1050	1050	1050	1050	1050	1050	1050	1050
≤ 260 Bhn or ≤ 26 HRc		81	RPM	17126	8563	4282	3211	2569	2141	1606	1284	
		(65-97)	Fr	0.055	0.109	0.218	0.291	0.364	0.437	0.582	0.728	
			Feed (mm/min)	935	935	935	935	935	935	935	935	

continued on next page

Series 135M 5D Metric		Hardness	Vc (m/min)	DC • mm								
				1.5	3	6	8	10	12	16	20	
N	ALUMINUM ALLOYS 2017, 2024, 356, 6061, 7075	≤ 80 Bhn or ≤ 47 HRb	194	RPM	41039	20519	10260	7695	6156	5130	3847	3078
			(155-232)	Fr	0.059	0.118	0.237	0.316	0.395	0.474	0.632	0.790
			Feed (mm/min)	2430	2430	2430	2430	2430	2430	2430	2430	
		≤ 150 Bhn or ≤ 88 HRc	165	RPM	34899	17449	8725	6544	5235	4362	3272	2617
			(132-198)	Fr	0.059	0.118	0.237	0.316	0.394	0.473	0.631	0.789
			Feed (mm/min)	2065	2065	2065	2065	2065	2065	2065	2065	2065
	Copper Alloys Alum Bronze, C110, Muntz Brass	≤ 140 Bhn or ≤ 3 HRc	137	RPM	29082	14541	7271	5453	4362	3635	2726	2181
			(110-165)	Fr	0.027	0.053	0.107	0.142	0.178	0.213	0.284	0.355
			Feed (mm/min)	775	775	775	775	775	775	775	775	775
		≤ 200 Bhn or ≤ 23 HRc	110	RPM	23266	11633	5816	4362	3490	2908	2181	1745
			(88-132)	Fr	0.027	0.054	0.108	0.144	0.181	0.217	0.289	0.361
			Feed (mm/min)	630	630	630	630	630	630	630	630	630
S	HIGH TEMP ALLOYS (Nickel, Cobalt, Iron Base) Inconel 601, 617, 625, Incoloy, Monel 400, Rene, Waspaloy	≤ 300 Bhn or ≤ 32 HRc	12	RPM	2585	1293	646	485	388	323	242	194
			(10-15)	Fr	0.010	0.019	0.039	0.052	0.064	0.077	0.103	0.129
			Feed (mm/min)	25	25	25	25	25	25	25	25	25
		≤ 400 Bhn or ≤ 43 HRc	6	RPM	1293	646	323	242	194	162	121	97
			(5-7)	Fr	0.007	0.014	0.028	0.037	0.046	0.056	0.074	0.093
			Feed (mm/min)	9	9	9	9	9	9	9	9	9
	TITANIUM ALLOYS Pure Titanium, Ti6Al4V, Ti6Al2Sn4Zr2Mo, Ti4Al4Mo2Sn0.5Si, Ti-6Al4V	≤ 275 Bhn or ≤ 28 HRc	32	RPM	6786	3393	1696	1272	1018	848	636	509
			(26-38)	Fr	0.021	0.043	0.085	0.114	0.142	0.171	0.228	0.285
			Feed (mm/min)	145	145	145	145	145	145	145	145	145
		≤ 350 Bhn or ≤ 38 HRc	24	RPM	5170	2585	1293	969	776	646	485	388
			(20-29)	Fr	0.019	0.039	0.077	0.103	0.129	0.155	0.206	0.258
			Feed (mm/min)	100	100	100	100	100	100	100	100	100
≤ 440 Bhn or ≤ 47 HRc	13	RPM	2714	1357	679	509	407	339	254	204		
	(10-15)	Fr	0.015	0.029	0.059	0.079	0.098	0.118	0.157	0.196		
	Feed (mm/min)	40	40	40	40	40	40	40	40	40		
H	TOOL STEELS A2, D2, H13, L2, M2, P20, S7, T15, W2	≤ 475 Bhn or ≤ 50 HRc	21	RPM	4524	2262	1131	848	679	565	424	339
			(17-26)	Fr	0.010	0.019	0.038	0.051	0.064	0.076	0.102	0.127
			Feed (mm/min)	43	43	43	43	43	43	43	43	43

Bhn (Brinell) HRc (Rockwell C) HRb (Rockwell B)
 $rpm = (Vc \times 1000) / (DC \times 3.14)$
 $mm/min = Fr \times rpm$
 reduce speed and feed for materials harder than listed
 refer to the SGS Tool Wizard® for complete technical information (www.kyocera-sgstool.com)



NEW SERIES

SERIES 146U / 136U

A ECCENTRIC 4-MARGIN DESIGN

- a unique coolant channel design allows repositioning of the trailing margins for improved stability over conventional two and four margin drills
- eccentric style clearance reduces margin contact with the workpiece without reducing strength

B END GEOMETRY

- the primary only relief allows the trailing margins to help stabilize the drill up to three times faster than conventional designs
- high shear corner geometry minimizes exit bur
- computer controlled edge hone protects against edge chipping in difficult applications

C COOLANT CHANNELS

- the two-channel design provides additional coolant in the hole when thru-tool coolant is not available

D COATING AND CARBIDE

- proprietary SGS Ti-NAMITE®-X coating and post-coat polishing combine to minimize material adhesion and maximize wear resistance in a wide range of workpiece materials
- all Series 146U and 136U drills are manufactured from lab certified premium quality carbide



HIGH PERFORMANCE CARBIDE DRILLS

The key features designed into the Hi-PerCarb® Series 146U and 136U Drills allow the product to offer application benefits not only beyond that of standard carbide drills, but also other High Performance drills. Each feature of the Hi-PerCarb® Series 146U and 136U Drills was uniquely engineered as a solution towards addressing the issues commonly encountered during high production drilling.

PERFORMANCE. PRECISION. PASSION.
HI-PERCARB® SERIES 146/136U FLAT BOTTOM DRILLS

PERFORMANCE.

HOLE DIAMETER VARIATION

4140 alloy steel / 19 HRc
2700 rpm / 25.4 ipm
straight blind holes with flood coolant

CMM diameter measurement of ten random holes shows the size variation produced by the Series 136U is ten times better than the competition.

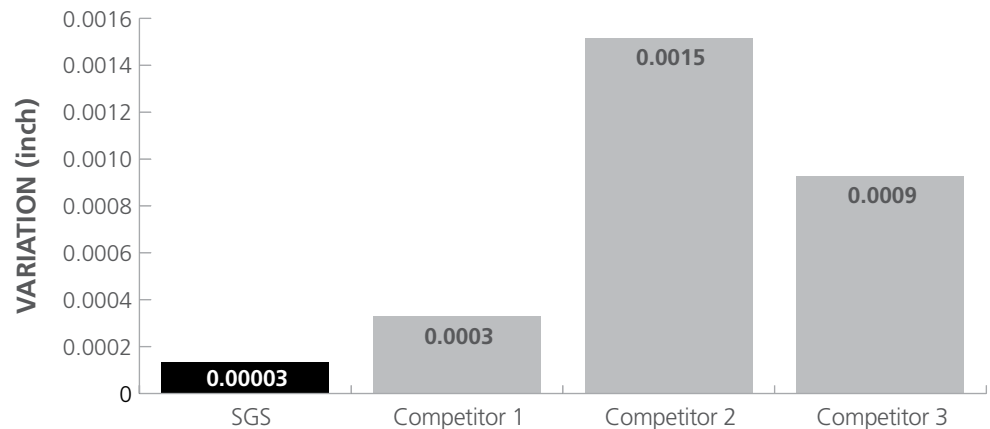

TOOL LIFE

4140 alloy steel / 19 HRc
2700 rpm / 25.4 ipm
straight blind holes with flood coolant

Tool life testing was performed until each drill exhibited sufficient damage to stop the test. Results show the Series 136U lasts 40 percent longer than competitor 2 and 250 percent longer than competitor 1.

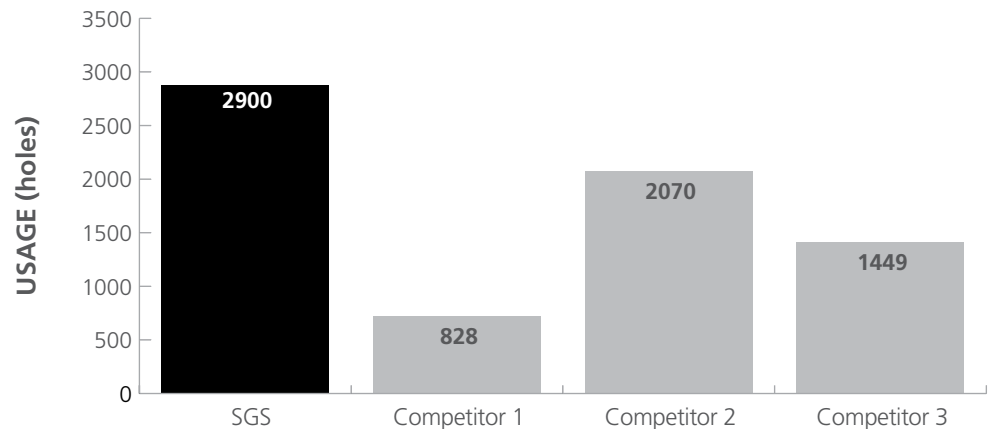

WALL STRAIGHTNESS

4140 alloy steel / 19 HRc
2700 rpm / 25.4 ipm
30° angle with flood coolant

Wall straightness of holes drilled on a 30° angle show the Series 136U produced 39 percent less deflection than competitor 3 and 57 percent less than competitor 2. During this test all tools were extended from the holder at an equal amount.

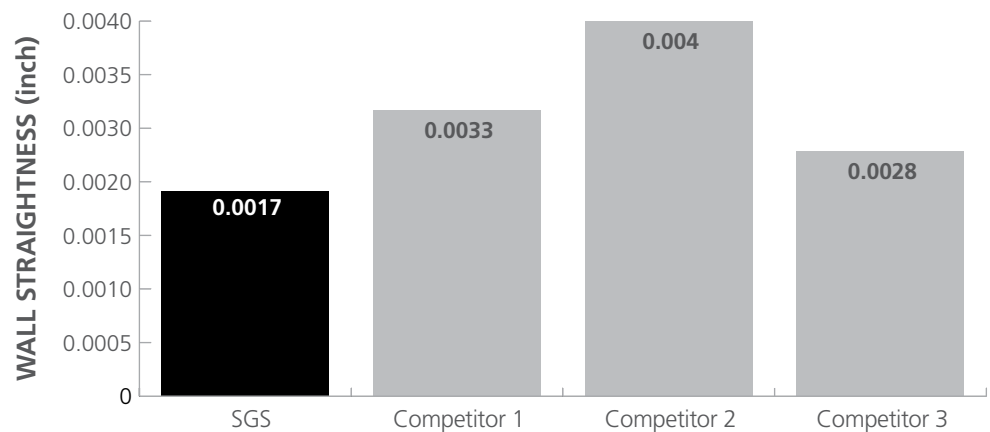

FRACTIONAL & METRIC Series 146U

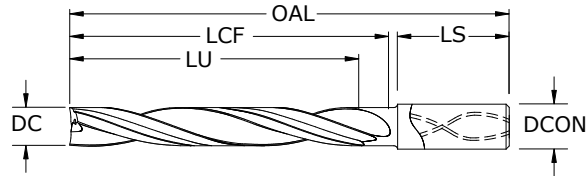

146U 3xD FRACTIONAL & METRIC SERIES

- 4-margin design improves accuracy and surface finish along with increased strength for aggressive drilling
- Specialized self-centering notched point eliminates the need for spot drilling decreasing thrust and deflection
- Engineered edge protection improves edge strength and reduces edge fatigue allowing for increased feed rates
- Recommended for materials ≤ 56 HRc (≤ 577 Bhn)

inch & mm								EDP NO.
DECIMAL DC	METRIC DC	FRACTIONAL/ LETTER/WIRE DC	SHANK DIAMETER DCON	OVERALL LENGTH OAL	FLUTE LENGTH LCF	USABLE LENGTH LU	SHANK LENGTH LS	Ti-NAMITE®-X (TX)
0.1181	3,000 mm		6,0	55,0	13,0	9,0	34,0	67705
0.1220	3,100 mm		6,0	55,0	14,0	9,0	34,0	67706
0.1250	3,175 mm	1/8	6,0	55,0	14,0	10,0	34,0	58800
0.1260	3,200 mm		6,0	55,0	14,0	10,0	34,0	67707
0.1299	3,300 mm		6,0	55,0	15,0	10,0	34,0	67708
0.1339	3,400 mm		6,0	55,0	15,0	10,0	34,0	67709
0.1360	3,454 mm	#29	6,0	55,0	16,0	10,0	34,0	58801
0.1378	3,500 mm		6,0	55,0	16,0	11,0	34,0	67710
0.1405	3,569 mm	#28	6,0	55,0	16,0	11,0	34,0	58802
0.1406	3,571 mm	9/64	6,0	55,0	16,0	11,0	34,0	58803
0.1417	3,600 mm		6,0	55,0	16,0	11,0	34,0	67711
0.1457	3,700 mm		6,0	60,0	17,0	11,0	34,0	67712
0.1470	3,734 mm	#26	6,0	60,0	17,0	11,0	34,0	58804
0.1495	3,797 mm	#25	6,0	60,0	17,0	11,0	34,0	58805
0.1496	3,800 mm		6,0	60,0	17,0	11,0	34,0	67713
0.1520	3,861 mm	#24	6,0	60,0	17,0	12,0	34,0	58806
0.1535	3,900 mm		6,0	60,0	18,0	12,0	34,0	67714
0.1562	3,967 mm	5/32	6,0	60,0	18,0	12,0	34,0	58807
0.1570	3,988 mm	#22	6,0	60,0	18,0	12,0	34,0	58808
0.1575	4,000 mm		6,0	60,0	18,0	12,0	34,0	67715
0.1590	4,039 mm	#21	6,0	60,0	18,0	12,0	34,0	58809
0.1610	4,089 mm	#20	6,0	60,0	18,0	12,0	34,0	58810
0.1614	4,100 mm		6,0	60,0	18,0	12,0	34,0	67716
0.1654	4,200 mm		6,0	60,0	19,0	13,0	34,0	67717
0.1693	4,300 mm		6,0	60,0	19,0	13,0	34,0	67718
0.1719	4,366 mm	11/64	6,0	60,0	20,0	13,0	34,0	58811
0.1732	4,400 mm		6,0	60,0	20,0	13,0	34,0	67719
0.1770	4,496 mm	#16	6,0	60,0	20,0	13,0	34,0	58812
0.1772	4,500 mm		6,0	60,0	20,0	14,0	34,0	67720
0.1811	4,600 mm		6,0	60,0	21,0	14,0	34,0	67721
0.1850	4,699 mm	#13	6,0	60,0	21,0	14,0	34,0	58813
0.1875	4,763 mm	3/16	6,0	60,0	21,0	14,0	34,0	58814
0.1890	4,801 mm	#12	6,0	65,0	22,0	14,0	33,0	58815
0.1929	4,900 mm		6,0	65,0	22,0	15,0	33,0	67724
0.1935	4,915 mm	#10	6,0	65,0	22,0	15,0	33,0	58816
0.1969	5,000 mm		6,0	65,0	23,0	15,0	33,0	67725
0.2008	5,100 mm		6,0	65,0	23,0	15,0	33,0	67726
0.2010	5,105 mm	#7	6,0	65,0	23,0	15,0	33,0	58817

TOLERANCES (inch)

- ≤.1181 DIAMETER**
DC = +.00008/+0.00047
DCON = h₆
- >.1181-.2362 DIAMETER**
DC = +.00016/+0.00063
DCON = h₆
- >.2362-.3937 DIAMETER**
DC = +.00024/+0.00083
DCON = h₆
- >.3937-.7087 DIAMETER**
DC = +.00028/+0.00098
DCON = h₆
- >.7087-1.1811 DIAMETER**
DC = +.00031/+0.00114
DCON = h₆

TOLERANCES (mm)

- ≤3 DIAMETER**
DC = +0,002/+0,012
DCON = h₆
- >3-6 DIAMETER**
DC = +0,004/+0,016
DCON = h₆
- >6-10 DIAMETER**
DC = +0,006/+0,021
DCON = h₆
- >10-18 DIAMETER**
DC = +0,007/+0,025
DCON = h₆
- >18-30 DIAMETER**
DC = +0,008/+0,029
DCON = h₆

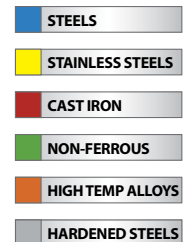

continued on next page

For patent information visit www.ksptpatents.com



146U 3xD

FRACTIONAL & METRIC SERIES

DECIMAL DC	METRIC DC	inch & mm						EDP NO.
		FRACTIONAL/ LETTER/WIRE DC	SHANK DIAMETER DCON	OVERALL LENGTH OAL	FLUTE LENGTH LCF	USABLE LENGTH LU	SHANK LENGTH LS	Ti-NAMITE®-X (TX)
0.2031	5,159 mm	13/64	6,0	65,0	23,0	15,0	33,0	58818
0.2047	5,200 mm		6,0	65,0	23,0	16,0	33,0	67727
0.2087	5,300 mm		6,0	65,0	24,0	16,0	33,0	67728
0.2090	5,309 mm	#4	6,0	65,0	24,0	16,0	33,0	58819
0.2126	5,400 mm		6,0	65,0	24,0	16,0	33,0	67729
0.2130	5,410 mm	#3	6,0	65,0	24,0	16,0	33,0	58820
0.2165	5,500 mm		6,0	65,0	25,0	16,0	33,0	67730
0.2188	5,558 mm	7/32	6,0	65,0	25,0	17,0	33,0	58821
0.2205	5,600 mm		6,0	65,0	25,0	17,0	33,0	67731
0.2244	5,700 mm		6,0	65,0	26,0	17,0	33,0	67732
0.2283	5,800 mm		6,0	65,0	26,0	17,0	33,0	67733
0.2323	5,900 mm		6,0	65,0	27,0	18,0	33,0	67734
0.2344	5,954 mm	15/64	6,0	65,0	27,0	18,0	33,0	58822
0.2362	6,000 mm		6,0	65,0	27,0	18,0	33,0	67735
0.2402	6,100 mm		8,0	70,0	28,0	19,0	34,0	67736
0.2441	6,200 mm		8,0	70,0	28,0	19,0	34,0	67737
0.2461	6,250 mm		8,0	70,0	28,0	19,0	34,0	67738
0.2480	6,300 mm		8,0	70,0	28,0	19,0	34,0	67739
0.2500	6,350 mm	1/4 E #0	8,0	70,0	29,0	19,0	34,0	58823
0.2520	6,400 mm		8,0	70,0	29,0	19,0	34,0	67740
0.2559	6,500 mm		8,0	70,0	29,0	19,0	34,0	67741
0.2570	6,528 mm	F	8,0	70,0	29,0	20,0	34,0	58824
0.2598	6,600 mm		8,0	70,0	30,0	20,0	34,0	67742
0.2638	6,700 mm		8,0	70,0	30,0	20,0	34,0	67743
0.2656	6,746 mm	17/64	8,0	70,0	30,0	20,0	34,0	58825
0.2677	6,800 mm		8,0	70,0	31,0	20,0	34,0	67744
0.2717	6,900 mm		8,0	70,0	31,0	21,0	34,0	67745
0.2720	6,909 mm	I	8,0	70,0	31,0	21,0	34,0	58826
0.2756	7,000 mm		8,0	75,0	32,0	21,0	34,0	67746
0.2795	7,100 mm		8,0	75,0	32,0	21,0	34,0	67747
0.2812	7,142 mm	9/32	8,0	75,0	32,0	21,0	34,0	58827
0.2835	7,200 mm		8,0	75,0	32,0	22,0	34,0	67748
0.2854	7,250 mm		8,0	75,0	33,0	22,0	34,0	67749
0.2874	7,300 mm		8,0	75,0	33,0	22,0	34,0	67750
0.2913	7,400 mm		8,0	75,0	33,0	22,0	34,0	67751
0.2953	7,500 mm		8,0	75,0	34,0	23,0	34,0	67752
0.2969	7,541 mm	19/64	8,0	75,0	34,0	23,0	34,0	58828
0.2992	7,600 mm		8,0	75,0	34,0	23,0	34,0	67753
0.3031	7,700 mm		8,0	75,0	35,0	23,0	34,0	67754
0.3071	7,800 mm		8,0	75,0	35,0	23,0	34,0	67755
0.3110	7,900 mm		8,0	75,0	36,0	24,0	34,0	67756
0.3125	7,938 mm	5/16	8,0	75,0	36,0	24,0	34,0	58829
0.3150	8,000 mm		8,0	75,0	36,0	24,0	34,0	67757
0.3189	8,100 mm		10,0	80,0	36,0	24,0	34,0	67758
0.3228	8,200 mm		10,0	80,0	37,0	25,0	34,0	67759
0.3268	8,300 mm		10,0	80,0	37,0	25,0	34,0	67760

CONTINUED

continued on next page

Series 146U 3xD | Fractional & Metric

FRACTIONAL & METRIC Series 146U

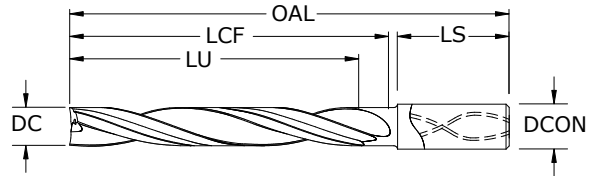

146U 3xD FRACTIONAL & METRIC SERIES

- 4-margin design improves accuracy and surface finish along with increased strength for aggressive drilling
- Specialized self-centering notched point eliminates the need for spot drilling decreasing thrust and deflection
- Engineered edge protection improves edge strength and reduces edge fatigue allowing for increased feed rates
- Recommended for materials ≤ 56 HRc (≤ 577 Bhn)

		inch & mm						EDP NO.
DECIMAL DC	METRIC DC	FRACTIONAL/ LETTER/WIRE DC	SHANK DIAMETER DCON	OVERALL LENGTH OAL	FLUTE LENGTH LCF	USABLE LENGTH LU	SHANK LENGTH LS	Ti-NAMITE®-X (TX)
0.3281	8,334 mm	21/64	10,0	80,0	38,0	25,0	34,0	58830
0.3307	8,400 mm		10,0	80,0	38,0	25,0	34,0	67761
0.3320	8,433 mm	Q	10,0	80,0	38,0	25,0	34,0	58831
0.3346	8,500 mm		10,0	80,0	38,0	25,0	34,0	67762
0.3386	8,600 mm		10,0	80,0	39,0	26,0	34,0	67763
0.3425	8,700 mm		10,0	80,0	39,0	26,0	34,0	67764
0.3438	8,733 mm	11/32	10,0	80,0	39,0	26,0	34,0	58832
0.3465	8,800 mm		10,0	80,0	40,0	26,0	34,0	67765
0.3504	8,900 mm		10,0	80,0	40,0	27,0	34,0	67766
0.3543	9,000 mm		10,0	80,0	40,0	27,0	34,0	67767
0.3583	9,100 mm		10,0	80,0	41,0	27,0	34,0	67768
0.3594	9,129 mm	23/64	10,0	80,0	41,0	27,0	34,0	58833
0.3622	9,200 mm		10,0	80,0	41,0	28,0	35,0	67769
0.3661	9,300 mm		10,0	85,0	42,0	28,0	35,0	67770
0.3680	9,347 mm	U	10,0	85,0	42,0	28,0	35,0	58834
0.3701	9,400 mm		10,0	85,0	42,0	28,0	35,0	67771
0.3740	9,500 mm		10,0	85,0	43,0	28,0	35,0	67772
0.3750	9,525 mm	3/8	10,0	85,0	43,0	29,0	35,0	58835
0.3780	9,600 mm		10,0	85,0	43,0	29,0	35,0	67773
0.3819	9,700 mm		10,0	85,0	44,0	29,0	35,0	67774
0.3858	9,800 mm		10,0	85,0	44,0	29,0	35,0	67775
0.3898	9,900 mm		10,0	85,0	45,0	30,0	35,0	67776
0.3906	9,921 mm	25/64	10,0	85,0	45,0	30,0	35,0	58836
0.3937	10,000 mm		10,0	85,0	45,0	30,0	35,0	67777
0.3970	10,084 mm	X	12,0	90,0	46,0	31,0	36,0	58837
0.3976	10,100 mm		12,0	90,0	46,0	31,0	36,0	67778
0.4016	10,200 mm		12,0	90,0	46,0	31,0	36,0	67779
0.4040	10,262 mm	Y	12,0	90,0	46,0	31,0	36,0	58838
0.4055	10,300 mm		12,0	90,0	46,0	31,0	36,0	67780
0.4062	10,317 mm	13/32	12,0	90,0	46,0	31,0	36,0	58839
0.4094	10,400 mm		12,0	90,0	47,0	31,0	36,0	67781
0.4134	10,500 mm		12,0	90,0	47,0	32,0	36,0	67782
0.4173	10,600 mm		12,0	90,0	48,0	32,0	36,0	67783
0.4213	10,700 mm		12,0	90,0	48,0	32,0	36,0	67784
0.4219	10,716 mm	27/64	12,0	90,0	48,0	32,0	36,0	58840
0.4252	10,800 mm		12,0	90,0	49,0	32,0	36,0	67785
0.4291	10,900 mm		12,0	90,0	49,0	33,0	36,0	67786
0.4331	11,000 mm		12,0	95,0	50,0	33,0	36,0	67787

TOLERANCES (inch)

- ≤.1181 DIAMETER**
DC = +.0008/+0.0047
DCON = h₆
- >.1181-.2362 DIAMETER**
DC = +.00016/+0.00063
DCON = h₆
- >.2362-.3937 DIAMETER**
DC = +.00024/+0.00083
DCON = h₆
- >.3937-.7087 DIAMETER**
DC = +.00028/+0.00098
DCON = h₆
- >.7087-1.1811 DIAMETER**
DC = +.00031/+0.00114
DCON = h₆

TOLERANCES (mm)

- ≤3 DIAMETER**
DC = +0,002/+0,012
DCON = h₆
- >3-6 DIAMETER**
DC = +0,004/+0,016
DCON = h₆
- >6-10 DIAMETER**
DC = +0,006/+0,021
DCON = h₆
- >10-18 DIAMETER**
DC = +0,007/+0,025
DCON = h₆
- >18-30 DIAMETER**
DC = +0,008/+0,029
DCON = h₆

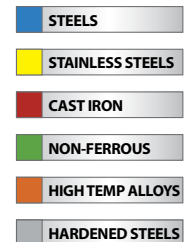

continued on next page

For patent information visit www.ksptpatents.com



FRACTIONAL & METRIC
Series 146U

146U 3xD

FRACTIONAL & METRIC SERIES

inch & mm								EDP NO.
DECIMAL DC	METRIC DC	FRACTIONAL/ LETTER/WIRE DC	SHANK DIAMETER DCON	OVERALL LENGTH OAL	FLUTE LENGTH LCF	USABLE LENGTH LU	SHANK LENGTH LS	Ti-NAMITE®-X (TX)
0.4370	11,100 mm		12,0	95,0	50,0	33,0	36,0	67788
0.4375	11,113 mm	7/16	12,0	95,0	50,0	33,0	36,0	58841
0.4409	11,200 mm		12,0	95,0	50,0	34,0	36,0	67789
0.4449	11,300 mm		12,0	95,0	51,0	34,0	36,0	67790
0.4488	11,400 mm		12,0	95,0	51,0	34,0	36,0	67791
0.4528	11,500 mm		12,0	95,0	52,0	35,0	36,0	67792
0.4531	11,509 mm	29/64	12,0	95,0	52,0	35,0	36,0	58842
0.4567	11,600 mm		12,0	95,0	52,0	35,0	36,0	67793
0.4606	11,700 mm		12,0	95,0	53,0	35,0	36,0	67794
0.4646	11,800 mm		12,0	95,0	53,0	35,0	36,0	67795
0.4685	11,900 mm		12,0	95,0	54,0	36,0	36,0	67796
0.4688	11,908 mm	15/32	12,0	95,0	54,0	36,0	36,0	58843
0.4724	12,000 mm		12,0	95,0	54,0	36,0	36,0	67797
0.4844	12,304 mm	31/64	14,0	105,0	55,0	37,0	37,0	58844
0.4921	12,500 mm		14,0	105,0	56,0	37,0	37,0	67798
0.5000	12,700 mm	1/2	14,0	105,0	57,0	38,0	37,0	58845
0.5039	12,800 mm		14,0	105,0	58,0	38,0	37,0	67799
0.5118	13,000 mm		14,0	105,0	58,0	39,0	37,0	67800
0.5156	13,096 mm	33/64	14,0	105,0	59,0	39,0	37,0	58846
0.5312	13,492 mm	17/32	14,0	105,0	61,0	40,0	37,0	58847
0.5315	13,500 mm		14,0	105,0	61,0	41,0	37,0	67801
0.5469	13,891 mm	35/64	14,0	105,0	63,0	42,0	37,0	58848
0.5512	14,000 mm		14,0	105,0	63,0	42,0	37,0	67802
0.5625	14,288 mm	9/16	16,0	115,0	64,0	43,0	38,0	58849
0.5709	14,500 mm		16,0	115,0	65,0	44,0	38,0	67803
0.5781	14,684 mm	37/64	16,0	115,0	66,0	44,0	38,0	58850
0.5906	15,000 mm		16,0	115,0	68,0	45,0	38,0	67804
0.5938	15,083 mm	19/32	16,0	115,0	68,0	45,0	38,0	58851
0.6094	15,479 mm	39/64	16,0	115,0	70,0	46,0	38,0	58852
0.6102	15,500 mm		16,0	115,0	70,0	46,0	38,0	67805
0.6250	15,875 mm	5/8	16,0	115,0	71,0	48,0	38,0	58853
0.6299	16,000 mm		16,0	115,0	72,0	48,0	38,0	67806
0.6406	16,271 mm	41/64	18,0	130,0	73,0	49,0	44,0	58854
0.6496	16,500 mm		18,0	130,0	74,0	49,0	44,0	67807
0.6562	16,667 mm	21/32	18,0	130,0	75,0	50,0	44,0	58855
0.6693	17,000 mm		18,0	130,0	77,0	51,0	44,0	67808
0.6719	17,066 mm	43/64	18,0	130,0	77,0	51,0	44,0	58856
0.6875	17,463 mm	11/16	18,0	130,0	79,0	52,0	44,0	58857
0.6890	17,500 mm		18,0	130,0	79,0	53,0	44,0	67809
0.7031	17,859 mm	45/64	18,0	130,0	80,0	54,0	44,0	58858
0.7087	18,000 mm		18,0	130,0	81,0	54,0	44,0	67810
0.7188	18,258 mm	23/32	20,0	140,0	82,0	55,0	45,0	58859
0.7283	18,500 mm		20,0	140,0	83,0	55,0	45,0	67811
0.7344	18,654 mm	47/64	20,0	140,0	84,0	56,0	45,0	58860
0.7480	19,000 mm		20,0	140,0	85,0	57,0	45,0	67812
0.7500	19,050 mm	3/4	20,0	140,0	86,0	57,0	45,0	58861

CONTINUED

continued on next page

Series 146U 3xD | Fractional & Metric

FRACTIONAL & METRIC Series 146U



146U 3xD FRACTIONAL & METRIC SERIES

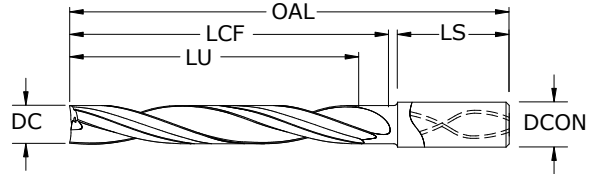

- 4-margin design improves accuracy and surface finish along with increased strength for aggressive drilling
- Specialized self-centering notched point eliminates the need for spot drilling decreasing thrust and deflection
- Engineered edge protection improves edge strength and reduces edge fatigue allowing for increased feed rates
- Recommended for materials ≤ 56 HRc (≤ 577 Bhn)

inch & mm								EDP NO.
DECIMAL DC	METRIC DC	FRACTIONAL/ LETTER/WIRE DC	SHANK DIAMETER DCON	OVERALL LENGTH OAL	FLUTE LENGTH LCF	USABLE LENGTH LU	SHANK LENGTH LS	Ti-NAMITE®-X (TX)
0.7656	19,446 mm	49/64	20,0	140,0	88,0	58,0	45,0	58862
0.7677	19,500 mm		20,0	140,0	88,0	58,0	45,0	67813
0.7812	19,842 mm	25/32	20,0	140,0	89,0	60,0	45,0	58863
0.7874	20,000 mm		20,0	140,0	90,0	60,0	45,0	67814
0.7969	20,241 mm	51/64	22,0	150,0	91,0	61,0	52,0	58864
0.8071	20,500 mm		22,0	150,0	92,0	62,0	52,0	67815
0.8125	20,638 mm	13/16	22,0	150,0	93,0	62,0	52,0	58865

TOLERANCES (inch)

- ≤.1181 DIAMETER**
DC = +.0008/+0.0047
DCON = h_6
- >.1181-.2362 DIAMETER**
DC = +.00016/+0.00063
DCON = h_6
- >.2362-.3937 DIAMETER**
DC = +.00024/+0.00083
DCON = h_6
- >.3937-.7087 DIAMETER**
DC = +.00028/+0.00098
DCON = h_6
- >.7087-1.1811 DIAMETER**
DC = +.00031/+0.00114
DCON = h_6

TOLERANCES (mm)

- ≤3 DIAMETER**
DC = +0,002/+0,012
DCON = h_6
- >3-6 DIAMETER**
DC = +0,004/+0,016
DCON = h_6
- >6-10 DIAMETER**
DC = +0,006/+0,021
DCON = h_6
- >10-18 DIAMETER**
DC = +0,007/+0,025
DCON = h_6
- >18-30 DIAMETER**
DC = +0,008/+0,029
DCON = h_6

- STEELS
- STAINLESS STEELS
- CAST IRON
- NON-FERROUS
- HIGH TEMP ALLOYS
- HARDENED STEELS

For patent information visit www.ksptpatents.com

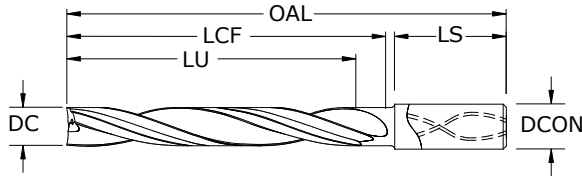

146U 5xD
FRACTIONAL & METRIC SERIES

TOLERANCES (inch)

- ≤.1181 DIAMETER**
DC = +.00008/+0.00047
DCON = h₆
- >.1181-.2362 DIAMETER**
DC = +.00016/+0.00063
DCON = h₆
- >.2362-.3937 DIAMETER**
DC = +.00024/+0.00083
DCON = h₆
- >.3937-.7087 DIAMETER**
DC = +.00028/+0.00098
DCON = h₆
- >.7087-1.1811 DIAMETER**
DC = +.00031/+0.00114
DCON = h₆

TOLERANCES (mm)

- ≤3 DIAMETER**
DC = +0,002/+0,012
DCON = h₆
- >3-6 DIAMETER**
DC = +0,004/+0,016
DCON = h₆
- >6-10 DIAMETER**
DC = +0,006/+0,021
DCON = h₆
- >10-18 DIAMETER**
DC = +0,007/+0,025
DCON = h₆
- >18-30 DIAMETER**
DC = +0,008/+0,029
DCON = h₆

- STEELS**
- STAINLESS STEELS**
- CAST IRON**
- HIGH TEMP ALLOYS**
- NON-FERROUS**

For patent information visit www.ksptpatents.com

		inch & mm						EDP NO.	
DECIMAL DC	METRIC DC	FRACTIONAL/ LETTER/WIRE DC	SHANK DIAMETER DCON	OVERALL LENGTH OAL	FLUTE LENGTH LCF	USABLE LENGTH LU	SHANK LENGTH LS	Ti-NAMITE®-X (TX)	
0.1181	3,000 mm		6,0	75,0	19,0	15,0	51,0	67816	
0.1220	3,100 mm		6,0	80,0	20,0	15,0	49,0	67817	
0.1250	3,175 mm	1/8	6,0	80,0	21,0	16,0	49,0	58866	
0.1260	3,200 mm		6,0	80,0	21,0	16,0	49,0	67818	
0.1299	3,300 mm		6,0	80,0	21,0	16,0	49,0	67819	
0.1339	3,400 mm		6,0	80,0	22,0	17,0	49,0	67820	
0.1360	3,454 mm	#29	6,0	80,0	22,0	17,0	49,0	58867	
0.1378	3,500 mm		6,0	80,0	23,0	18,0	49,0	67821	
0.1405	3,569 mm	#28	6,0	80,0	23,0	18,0	49,0	58868	
0.1406	3,571 mm	9/64	6,0	80,0	23,0	18,0	49,0	58869	
0.1417	3,600 mm		6,0	80,0	23,0	18,0	49,0	67822	
0.1457	3,700 mm		6,0	80,0	24,0	19,0	49,0	67823	
0.1470	3,734 mm	#26	6,0	80,0	24,0	19,0	49,0	58870	
0.1495	3,797 mm	#25	6,0	80,0	25,0	19,0	49,0	58871	
0.1496	3,800 mm		6,0	80,0	25,0	19,0	49,0	67824	
0.1520	3,861 mm	#24	6,0	80,0	25,0	19,0	49,0	58872	
0.1535	3,900 mm		6,0	80,0	25,0	19,0	49,0	67825	
0.1562	3,967 mm	5/32	6,0	80,0	26,0	20,0	49,0	58873	
0.1570	3,988 mm	#22	6,0	80,0	26,0	20,0	49,0	58874	
0.1575	4,000 mm		6,0	80,0	26,0	20,0	49,0	67826	
0.1590	4,039 mm	#21	6,0	80,0	26,0	20,0	49,0	58875	
0.1610	4,089 mm	#20	6,0	90,0	27,0	20,0	53,0	58876	
0.1614	4,100 mm		6,0	90,0	27,0	20,0	53,0	67827	
0.1654	4,200 mm		6,0	90,0	27,0	21,0	53,0	67828	
0.1693	4,300 mm		6,0	90,0	28,0	22,0	53,0	67829	
0.1719	4,366 mm	11/64	6,0	90,0	28,0	22,0	53,0	58877	
0.1732	4,400 mm		6,0	90,0	29,0	22,0	53,0	67830	
0.1770	4,496 mm	#16	6,0	90,0	29,0	22,0	53,0	58878	
0.1772	4,500 mm		6,0	90,0	29,0	23,0	53,0	67831	
0.1811	4,600 mm		6,0	90,0	30,0	23,0	53,0	67832	
0.1850	4,699 mm	#13	6,0	90,0	31,0	23,0	53,0	58879	
0.1875	4,763 mm	3/16	6,0	90,0	31,0	24,0	53,0	58880	
0.1890	4,801 mm	#12	6,0	90,0	31,0	24,0	53,0	58881	
0.1929	4,900 mm		6,0	90,0	32,0	24,0	53,0	67835	
0.1935	4,915 mm	#10	6,0	90,0	32,0	25,0	53,0	58882	
0.1969	5,000 mm		6,0	95,0	33,0	25,0	51,0	67836	
0.2008	5,100 mm		6,0	95,0	33,0	26,0	51,0	67837	
0.2010	5,105 mm	#7	6,0	95,0	33,0	26,0	51,0	58883	
0.2031	5,159 mm	13/64	6,0	95,0	34,0	26,0	51,0	58884	
0.2047	5,200 mm		6,0	95,0	34,0	26,0	51,0	67838	
0.2087	5,300 mm		6,0	95,0	34,0	27,0	51,0	67839	
0.2090	5,309 mm	#4	6,0	95,0	35,0	27,0	51,0	58885	

- 4-margin design improves accuracy and surface finish along with increased strength for aggressive drilling
- Specialized self-centering notched point eliminates the need for spot drilling decreasing thrust and deflection
- Engineered edge protection improves edge strength and reduces edge fatigue allowing for increased feed rates
- Recommended for materials ≤ 56 HRC (≤ 577 Bhn)

Series 146U 5xD Fractional & Metric

continued on next page

FRACTIONAL & METRIC Series 146U

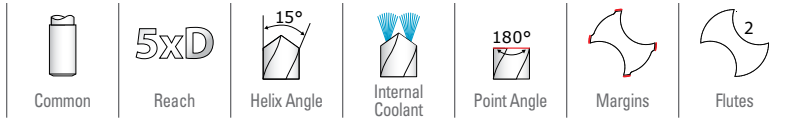

146U 5xD FRACTIONAL & METRIC SERIES

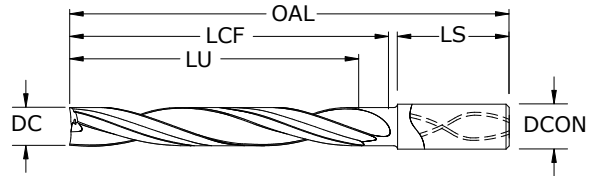

- 4-margin design improves accuracy and surface finish along with increased strength for aggressive drilling
- Specialized self-centering notched point eliminates the need for spot drilling decreasing thrust and deflection
- Engineered edge protection improves edge strength and reduces edge fatigue allowing for increased feed rates
- Recommended for materials ≤ 56 HRC (≤ 577 Bhn)

		inch & mm							EDP NO.
DECIMAL DC	METRIC DC	FRACTIONAL/ LETTER/WIRE DC	SHANK DIAMETER DCON	OVERALL LENGTH OAL	FLUTE LENGTH LCF	USABLE LENGTH LU	SHANK LENGTH LS	Ti-NAMITE®-X (TX)	
0.2126	5,400 mm		6,0	95,0	35,0	27,0	51,0	67840	
0.2130	5,410 mm	#3	6,0	95,0	35,0	27,0	51,0	58886	
0.2165	5,500 mm		6,0	95,0	36,0	27,0	51,0	67841	
0.2188	5,558 mm	7/32	6,0	95,0	36,0	28,0	51,0	58887	
0.2205	5,600 mm		6,0	95,0	36,0	28,0	51,0	67842	
0.2244	5,700 mm		6,0	95,0	37,0	28,0	51,0	67843	
0.2283	5,800 mm		6,0	95,0	38,0	29,0	51,0	67844	
0.2323	5,900 mm		6,0	95,0	38,0	30,0	51,0	67845	
0.2344	5,954 mm	15/64	6,0	95,0	39,0	30,0	51,0	58888	
0.2362	6,000 mm		6,0	95,0	39,0	30,0	51,0	67846	
0.2402	6,100 mm		8,0	100,0	40,0	31,0	49,0	67847	
0.2441	6,200 mm		8,0	100,0	40,0	31,0	49,0	67848	
0.2461	6,250 mm		8,0	100,0	41,0	31,0	49,0	67849	
0.2480	6,300 mm		8,0	100,0	41,0	31,0	49,0	67850	
0.2500	6,350 mm	1/4 E #0	8,0	100,0	41,0	32,0	49,0	58889	
0.2520	6,400 mm		8,0	100,0	42,0	32,0	49,0	67851	
0.2559	6,500 mm		8,0	100,0	42,0	32,0	49,0	67852	
0.2570	6,528 mm	F	8,0	100,0	42,0	33,0	49,0	58890	
0.2598	6,600 mm		8,0	100,0	43,0	33,0	49,0	67853	
0.2638	6,700 mm		8,0	100,0	44,0	34,0	49,0	67854	
0.2656	6,746 mm	17/64	8,0	100,0	44,0	34,0	49,0	58891	
0.2677	6,800 mm		8,0	100,0	44,0	34,0	49,0	67855	
0.2717	6,900 mm		8,0	100,0	45,0	35,0	49,0	67856	
0.2720	6,909 mm	I	8,0	100,0	45,0	35,0	49,0	58892	
0.2756	7,000 mm		8,0	100,0	46,0	35,0	49,0	67857	
0.2795	7,100 mm		8,0	100,0	46,0	35,0	49,0	67858	
0.2812	7,142 mm	9/32	8,0	100,0	46,0	36,0	49,0	58893	
0.2835	7,200 mm		8,0	110,0	47,0	36,0	53,0	67859	
0.2854	7,250 mm		8,0	110,0	47,0	36,0	53,0	67860	
0.2874	7,300 mm		8,0	110,0	47,0	36,0	53,0	67861	
0.2913	7,400 mm		8,0	110,0	48,0	37,0	53,0	67862	
0.2953	7,500 mm		8,0	110,0	49,0	38,0	53,0	67863	
0.2969	7,541 mm	19/64	8,0	110,0	49,0	38,0	53,0	58894	
0.2992	7,600 mm		8,0	110,0	49,0	38,0	53,0	67864	
0.3031	7,700 mm		8,0	110,0	50,0	38,0	53,0	67865	
0.3071	7,800 mm		8,0	110,0	51,0	39,0	53,0	67866	
0.3110	7,900 mm		8,0	110,0	51,0	39,0	53,0	67867	
0.3125	7,938 mm	5/16	8,0	110,0	52,0	40,0	53,0	58895	
0.3150	8,000 mm		8,0	110,0	52,0	40,0	53,0	67868	
0.3189	8,100 mm		10,0	115,0	53,0	41,0	51,0	67869	
0.3228	8,200 mm		10,0	115,0	53,0	41,0	51,0	67870	
0.3268	8,300 mm		10,0	115,0	54,0	42,0	51,0	67871	

TOLERANCES (inch)

- ≤.1181 DIAMETER**
DC = +.00008/+0.00047
DCON = h_6
- >.1181-.2362 DIAMETER**
DC = +.00016/+0.00063
DCON = h_6
- >.2362-.3937 DIAMETER**
DC = +.00024/+0.00083
DCON = h_6
- >.3937-.7087 DIAMETER**
DC = +.00028/+0.00098
DCON = h_6
- >.7087-1.1811 DIAMETER**
DC = +.00031/+0.00114
DCON = h_6

TOLERANCES (mm)

- ≤3 DIAMETER**
DC = +0,002/+0,012
DCON = h_6
- >3-6 DIAMETER**
DC = +0,004/+0,016
DCON = h_6
- >6-10 DIAMETER**
DC = +0,006/+0,021
DCON = h_6
- >10-18 DIAMETER**
DC = +0,007/+0,025
DCON = h_6
- >18-30 DIAMETER**
DC = +0,008/+0,029
DCON = h_6

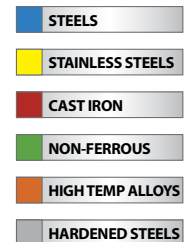

For patent information visit www.ksptpatents.com

continued on next page



FRACTIONAL & METRIC
Series 146U

146U 5xD
 FRACTIONAL & METRIC SERIES

inch & mm								EDP NO.
DECIMAL DC	METRIC DC	FRACTIONAL/ LETTER/WIRE DC	SHANK DIAMETER DCON	OVERALL LENGTH OAL	FLUTE LENGTH LCF	USABLE LENGTH LU	SHANK LENGTH LS	Ti-NAMITE [®] -X (TX)
0.3281	8,334 mm	21/64	10,0	115,0	54,0	42,0	51,0	58896
0.3307	8,400 mm		10,0	115,0	55,0	42,0	51,0	67872
0.3320	8,433 mm	Q	10,0	115,0	55,0	42,0	51,0	58897
0.3346	8,500 mm		10,0	115,0	55,0	42,0	51,0	67873
0.3386	8,600 mm		10,0	115,0	56,0	43,0	51,0	67874
0.3425	8,700 mm		10,0	115,0	57,0	43,0	51,0	67875
0.3438	8,733 mm	11/32	10,0	115,0	57,0	44,0	51,0	58898
0.3465	8,800 mm		10,0	115,0	57,0	44,0	51,0	67876
0.3504	8,900 mm		10,0	115,0	58,0	45,0	51,0	67877
0.3543	9,000 mm		10,0	115,0	58,0	45,0	51,0	67878
0.3583	9,100 mm		10,0	115,0	59,0	46,0	51,0	67879
0.3594	9,129 mm	23/64	10,0	115,0	59,0	46,0	51,0	58899
0.3622	9,200 mm		10,0	125,0	60,0	46,0	55,0	67880
0.3661	9,300 mm		10,0	125,0	60,0	46,0	55,0	67881
0.3680	9,347 mm	U	10,0	125,0	61,0	47,0	55,0	58900
0.3701	9,400 mm		10,0	125,0	61,0	47,0	55,0	67882
0.3740	9,500 mm		10,0	125,0	62,0	47,0	55,0	67883
0.3750	9,525 mm	3/8	10,0	125,0	62,0	48,0	55,0	58901
0.3780	9,600 mm		10,0	125,0	62,0	48,0	55,0	67884
0.3819	9,700 mm		10,0	125,0	63,0	49,0	55,0	67885
0.3858	9,800 mm		10,0	125,0	64,0	49,0	55,0	67886
0.3898	9,900 mm		10,0	125,0	64,0	50,0	55,0	67887
0.3906	9,921 mm	25/64	10,0	125,0	64,0	50,0	55,0	58902
0.3937	10,000 mm		10,0	125,0	65,0	50,0	55,0	67888
0.3970	10,084 mm	X	12,0	135,0	66,0	50,0	57,0	58903
0.3976	10,100 mm		12,0	135,0	66,0	50,0	57,0	67889
0.4016	10,200 mm		12,0	135,0	66,0	51,0	57,0	67890
0.4040	10,262 mm	Y	12,0	135,0	67,0	51,0	57,0	58904
0.4055	10,300 mm		12,0	135,0	67,0	51,0	57,0	67891
0.4062	10,317 mm	13/32	12,0	135,0	67,0	52,0	57,0	58905
0.4094	10,400 mm		12,0	135,0	68,0	52,0	57,0	67892
0.4134	10,500 mm		12,0	135,0	68,0	53,0	57,0	67893
0.4173	10,600 mm		12,0	135,0	69,0	53,0	57,0	67894
0.4213	10,700 mm		12,0	135,0	70,0	54,0	57,0	67895
0.4219	10,716 mm	27/64	12,0	135,0	70,0	54,0	57,0	58906
0.4252	10,800 mm		12,0	135,0	70,0	54,0	57,0	67896
0.4291	10,900 mm		12,0	135,0	71,0	54,0	57,0	67897
0.4331	11,000 mm		12,0	135,0	72,0	55,0	57,0	67898
0.4370	11,100 mm		12,0	135,0	72,0	55,0	57,0	67899
0.4375	11,113 mm	7/16	12,0	135,0	72,0	56,0	57,0	58907
0.4409	11,200 mm		12,0	135,0	73,0	56,0	57,0	67900
0.4449	11,300 mm		12,0	135,0	73,0	57,0	57,0	67901
0.4488	11,400 mm		12,0	145,0	74,0	57,0	62,0	67902
0.4528	11,500 mm		12,0	145,0	75,0	58,0	62,0	67903
0.4531	11,509 mm	29/64	12,0	145,0	75,0	58,0	62,0	58908
0.4567	11,600 mm		12,0	145,0	75,0	58,0	62,0	67904
0.4606	11,700 mm		12,0	145,0	76,0	58,0	62,0	67905
0.4646	11,800 mm		12,0	145,0	77,0	59,0	62,0	67906
0.4685	11,900 mm		12,0	145,0	77,0	59,0	62,0	67907
0.4688	11,908 mm	15/32	12,0	145,0	77,0	60,0	62,0	58909

CONTINUED

continued on next page

Series 146U 5xD | Fractional & Metric

FRACTIONAL & METRIC Series 146U



146U 5xD FRACTIONAL & METRIC SERIES

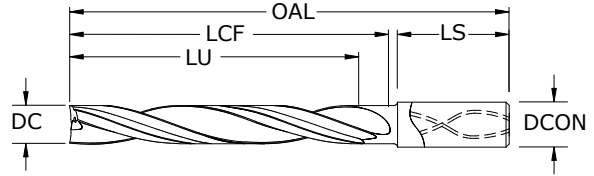

- 4-margin design improves accuracy and surface finish along with increased strength for aggressive drilling
- Specialized self-centering notched point eliminates the need for spot drilling decreasing thrust and deflection
- Engineered edge protection improves edge strength and reduces edge fatigue allowing for increased feed rates
- Recommended for materials ≤ 56 HRc (≤ 577 Bhn)

DECIMAL DC	METRIC DC	inch & mm		OVERALL LENGTH OAL	FLUTE LENGTH LCF	USABLE LENGTH LU	SHANK LENGTH LS	EDP NO.
		FRACTIONAL/ LETTER/WIRE DC	SHANK DIAMETER DCON					
0.4724	12,000 mm		12,0	145,0	78,0	60,0	62,0	67908
0.4844	12,304 mm	31/64	14,0	155,0	80,0	62,0	59,0	58910
0.4921	12,500 mm		14,0	155,0	81,0	62,0	59,0	67909
0.5000	12,700 mm	1/2	14,0	155,0	83,0	64,0	59,0	58911
0.5039	12,800 mm		14,0	155,0	83,0	64,0	59,0	67910
0.5118	13,000 mm		14,0	155,0	84,0	65,0	59,0	67911
0.5156	13,096 mm	33/64	14,0	155,0	85,0	65,0	59,0	58912
0.5312	13,492 mm	17/32	14,0	155,0	88,0	67,0	59,0	58913
0.5315	13,500 mm		14,0	155,0	88,0	68,0	59,0	67912
0.5469	13,891 mm	35/64	14,0	155,0	90,0	69,0	59,0	58914
0.5512	14,000 mm		14,0	155,0	91,0	70,0	59,0	67913
0.5625	14,288 mm	9/16	16,0	175,0	93,0	71,0	66,0	58915
0.5709	14,500 mm		16,0	175,0	94,0	73,0	66,0	67914
0.5781	14,684 mm	37/64	16,0	175,0	95,0	73,0	66,0	58916
0.5906	15,000 mm		16,0	175,0	98,0	75,0	66,0	67915
0.5938	15,083 mm	19/32	16,0	175,0	98,0	75,0	66,0	58917
0.6094	15,479 mm	39/64	16,0	175,0	101,0	77,0	66,0	58918
0.6102	15,500 mm		16,0	175,0	101,0	77,0	66,0	67916
0.6250	15,875 mm	5/8	16,0	175,0	103,0	79,0	66,0	58919
0.6299	16,000 mm		16,0	175,0	104,0	80,0	66,0	67917
0.6406	16,271 mm	41/64	18,0	195,0	106,0	81,0	73,0	58920
0.6496	16,500 mm		18,0	195,0	107,0	82,0	73,0	67918
0.6562	16,667 mm	21/32	18,0	195,0	108,0	83,0	73,0	58921
0.6693	17,000 mm		18,0	195,0	111,0	85,0	73,0	67919
0.6719	17,066 mm	43/64	18,0	195,0	111,0	85,0	73,0	58922
0.6875	17,463 mm	11/16	18,0	195,0	114,0	87,0	73,0	58923
0.6890	17,500 mm		18,0	195,0	114,0	88,0	73,0	67920
0.7031	17,859 mm	45/64	18,0	195,0	116,0	89,0	73,0	58924
0.7087	18,000 mm		18,0	195,0	117,0	90,0	73,0	67921
0.7188	18,258 mm	23/32	20,0	215,0	119,0	91,0	80,0	58925
0.7283	18,500 mm		20,0	215,0	120,0	92,0	80,0	67922
0.7344	18,654 mm	47/64	20,0	215,0	121,0	93,0	80,0	58926
0.7480	19,000 mm		20,0	215,0	123,0	95,0	80,0	67923
0.7500	19,050 mm	3/4	20,0	215,0	124,0	95,0	80,0	58927
0.7656	19,446 mm	49/64	20,0	215,0	126,0	97,0	80,0	58928
0.7677	19,500 mm		20,0	215,0	127,0	97,0	80,0	67924
0.7812	19,842 mm	25/32	20,0	215,0	129,0	99,0	80,0	58929
0.7874	20,000 mm		20,0	215,0	130,0	100,0	80,0	67925
0.7969	20,241 mm	51/64	22,0	220,0	132,0	101,0	81,0	58930
0.8071	20,500 mm		22,0	220,0	133,0	103,0	81,0	67926
0.8125	20,638 mm	13/16	22,0	220,0	134,0	103,0	81,0	58931

TOLERANCES (inch)

- $\leq .1181$ DIAMETER**
DC = $+0.0008/+0.0047$
DCON = h_6
- $>.1181-.2362$ DIAMETER**
DC = $+0.0016/+0.0063$
DCON = h_6
- $>.2362-.3937$ DIAMETER**
DC = $+0.0024/+0.0083$
DCON = h_6
- $>.3937-.7087$ DIAMETER**
DC = $+0.0028/+0.0098$
DCON = h_6
- $>.7087-1.1811$ DIAMETER**
DC = $+0.0031/+0.0114$
DCON = h_6

TOLERANCES (mm)

- ≤ 3 DIAMETER**
DC = $+0,002/+0,012$
DCON = h_6
- $>3-6$ DIAMETER**
DC = $+0,004/+0,016$
DCON = h_6
- $>6-10$ DIAMETER**
DC = $+0,006/+0,021$
DCON = h_6
- $>10-18$ DIAMETER**
DC = $+0,007/+0,025$
DCON = h_6
- $>18-30$ DIAMETER**
DC = $+0,008/+0,029$
DCON = h_6

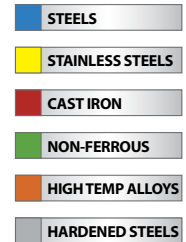

For patent information visit www.ksptpatents.com

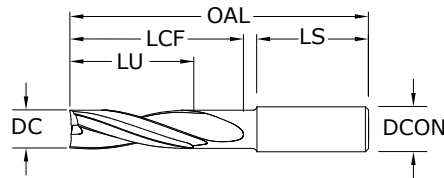

136U 2xD
FRACTIONAL & METRIC SERIES

TOLERANCES (inch)

≤.1181 DIAMETER
DC = +.00008/+0.00047
DCON = h₆

>.1181-.2362 DIAMETER
DC = +.00016/+0.00063
DCON = h₆

>.2362-.3937 DIAMETER
DC = +.00024/+0.00083
DCON = h₆

>.3937-.7087 DIAMETER
DC = +.00028/+0.00098
DCON = h₆

>.7087-1.1811 DIAMETER
DC = +.00031/+0.00114
DCON = h₆

TOLERANCES (mm)

≤3 DIAMETER
DC = +0,002/+0,012
DCON = h₆

>3-6 DIAMETER
DC = +0,004/+0,016
DCON = h₆

>6-10 DIAMETER
DC = +0,006/+0,021
DCON = h₆

>10-18 DIAMETER
DC = +0,007/+0,025
DCON = h₆

>18-30 DIAMETER
DC = +0,008/+0,029
DCON = h₆

STEELS

STAINLESS STEELS

CAST IRON

HIGH TEMP ALLOYS

NON-FERROUS

For patent information visit www.ksptpatents.com

inch & mm								EDP NO.
DECIMAL DC	METRIC DC	FRACTIONAL/ LETTER/WIRE DC	SHANK DIAMETER DCON	OVERALL LENGTH OAL	FLUTE LENGTH LCF	USABLE LENGTH LU	SHANK LENGTH LS	Ti-NAMITE®-X (TX)
0.0591	1,500 mm		6,0	45,0	5,0	3,0	33,0	67060
0.0625	1,588 mm	1/16	6,0	45,0	6,0	3,0	33,0	58480
0.0630	1,600 mm		6,0	45,0	6,0	3,0	33,0	67061
0.0669	1,700 mm		6,0	45,0	6,0	3,0	33,0	67062
0.0709	1,800 mm		6,0	45,0	6,0	4,0	33,0	67063
0.0748	1,900 mm		6,0	45,0	7,0	4,0	33,0	67064
0.0781	1,984 mm	5/64	6,0	45,0	7,0	4,0	33,0	58481
0.0787	2,000 mm		6,0	45,0	7,0	4,0	33,0	67065
0.0827	2,100 mm		6,0	45,0	7,0	4,0	33,0	67066
0.0866	2,200 mm		6,0	50,0	8,0	4,0	31,0	67067
0.0906	2,300 mm		6,0	50,0	8,0	5,0	31,0	67068
0.0938	2,383 mm	3/32	6,0	50,0	8,0	5,0	31,0	58482
0.0945	2,400 mm		6,0	50,0	8,0	5,0	31,0	67069
0.0984	2,500 mm		6,0	50,0	9,0	5,0	31,0	67070
0.1015	2,578 mm	#38	6,0	50,0	9,0	5,0	31,0	58483
0.1024	2,600 mm		6,0	50,0	9,0	5,0	31,0	67071
0.1040	2,642 mm	#37	6,0	50,0	9,0	5,0	31,0	58484
0.1063	2,700 mm		6,0	50,0	9,0	5,0	31,0	67072
0.1065	2,705 mm	#36	6,0	50,0	9,0	5,0	31,0	58485
0.1094	2,779 mm	7/64	6,0	50,0	10,0	6,0	31,0	58486
0.1102	2,800 mm		6,0	50,0	10,0	6,0	31,0	67073
0.1130	2,870 mm	#33	6,0	50,0	10,0	6,0	31,0	58487
0.1142	2,900 mm		6,0	50,0	10,0	6,0	31,0	67074
0.1181	3,000 mm		6,0	50,0	10,0	6,0	31,0	67075
0.1220	3,100 mm		6,0	50,0	11,0	6,0	31,0	67076
0.1250	3,175 mm	1/8	6,0	50,0	11,0	6,0	31,0	58488
0.1260	3,200 mm		6,0	50,0	11,0	6,0	31,0	67077
0.1299	3,300 mm		6,0	50,0	12,0	7,0	31,0	67078
0.1339	3,400 mm		6,0	50,0	12,0	7,0	31,0	67079
0.1360	3,454 mm	#29	6,0	50,0	12,0	7,0	31,0	58489
0.1378	3,500 mm		6,0	50,0	12,0	7,0	31,0	67080
0.1405	3,569 mm	#28	6,0	50,0	12,0	7,0	31,0	58490
0.1406	3,571 mm	9/64	6,0	50,0	12,0	7,0	31,0	58491
0.1417	3,600 mm		6,0	50,0	13,0	7,0	31,0	67081
0.1457	3,700 mm		6,0	50,0	13,0	7,0	31,0	67082
0.1470	3,734 mm	#26	6,0	50,0	13,0	7,0	31,0	58492
0.1495	3,797 mm	#25	6,0	50,0	13,0	8,0	31,0	58493
0.1496	3,800 mm		6,0	50,0	13,0	8,0	31,0	67083

- 4-margin design improves accuracy and surface finish along with increased strength for aggressive drilling
- Specialized self-centering notched point eliminates the need for spot drilling decreasing thrust and deflection
- Engineered edge protection improves edge strength and reduces edge fatigue allowing for increased feed rates
- Recommended for materials ≤ 56 HRC (≤ 577 Bhn)

Series 136U 2xD | Fractional & Metric

continued on next page

FRACTIONAL & METRIC Series 136U

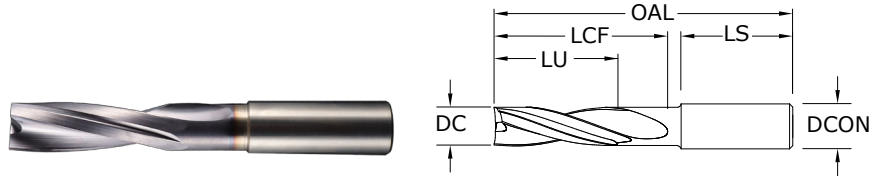

136U 2xD FRACTIONAL & METRIC SERIES

- 4-margin design improves accuracy and surface finish along with increased strength for aggressive drilling
- Specialized self-centering notched point eliminates the need for spot drilling decreasing thrust and deflection
- Engineered edge protection improves edge strength and reduces edge fatigue allowing for increased feed rates
- Recommended for materials ≤ 56 HRc (≤ 577 Bhn)

inch & mm								EDP NO.
DECIMAL DC	METRIC DC	FRACTIONAL/ LETTER/WIRE DC	SHANK DIAMETER DCON	OVERALL LENGTH OAL	FLUTE LENGTH LCF	USABLE LENGTH LU	SHANK LENGTH LS	Ti-NAMITE [®] -X (TX)
0.1520	3,861 mm	#24	6,0	50,0	14,0	8,0	31,0	58494
0.1535	3,900 mm		6,0	50,0	14,0	8,0	31,0	67084
0.1562	3,967 mm	5/32	6,0	50,0	14,0	8,0	31,0	58495
0.1570	3,988 mm	#22	6,0	50,0	14,0	8,0	31,0	58496
0.1575	4,000 mm		6,0	50,0	14,0	8,0	31,0	67085
0.1590	4,039 mm	#21	6,0	50,0	14,0	8,0	31,0	58497
0.1610	4,089 mm	#20	6,0	50,0	14,0	8,0	31,0	58498
0.1614	4,100 mm		6,0	50,0	14,0	8,0	31,0	67086
0.1654	4,200 mm		6,0	60,0	15,0	8,0	34,0	67087
0.1693	4,300 mm		6,0	60,0	15,0	9,0	34,0	67088
0.1719	4,366 mm	11/64	6,0	60,0	15,0	9,0	34,0	58499
0.1732	4,400 mm		6,0	60,0	15,0	9,0	34,0	67089
0.1770	4,496 mm	#16	6,0	60,0	16,0	9,0	34,0	58500
0.1772	4,500 mm		6,0	60,0	16,0	9,0	34,0	67090
0.1811	4,600 mm		6,0	60,0	16,0	9,0	34,0	67091
0.1850	4,699 mm	#13	6,0	60,0	16,0	9,0	34,0	58501
0.1875	4,763 mm	3/16	6,0	60,0	17,0	10,0	34,0	58502
0.1890	4,801 mm	#12	6,0	60,0	17,0	10,0	34,0	58503
0.1929	4,900 mm		6,0	60,0	17,0	10,0	34,0	67094
0.1935	4,915 mm	#10	6,0	60,0	17,0	10,0	34,0	58504
0.1969	5,000 mm		6,0	60,0	18,0	10,0	34,0	67095
0.2008	5,100 mm		6,0	60,0	18,0	10,0	34,0	67096
0.2010	5,105 mm	#7	6,0	60,0	18,0	10,0	34,0	58505
0.2031	5,159 mm	13/64	6,0	60,0	18,0	10,0	34,0	58506
0.2047	5,200 mm		6,0	60,0	18,0	10,0	34,0	67097
0.2087	5,300 mm		6,0	60,0	19,0	11,0	34,0	67098
0.2090	5,309 mm	#4	6,0	60,0	19,0	11,0	34,0	58507
0.2126	5,400 mm		6,0	60,0	19,0	11,0	34,0	67099
0.2130	5,410 mm	#3	6,0	60,0	19,0	11,0	34,0	58508
0.2165	5,500 mm		6,0	60,0	19,0	11,0	34,0	67100
0.2188	5,558 mm	7/32	6,0	60,0	19,0	11,0	34,0	58509
0.2205	5,600 mm		6,0	60,0	20,0	11,0	34,0	67101
0.2244	5,700 mm		6,0	60,0	20,0	11,0	34,0	67102
0.2283	5,800 mm		6,0	60,0	20,0	12,0	34,0	67103
0.2323	5,900 mm		6,0	60,0	21,0	12,0	34,0	67104
0.2344	5,954 mm	15/64	6,0	60,0	21,0	12,0	34,0	58510
0.2362	6,000 mm		6,0	60,0	21,0	12,0	34,0	67105
0.2402	6,100 mm		8,0	70,0	22,0	13,0	37,0	67106
0.2441	6,200 mm		8,0	70,0	22,0	12,0	37,0	67107
0.2461	6,250 mm		8,0	70,0	22,0	13,0	37,0	67108

TOLERANCES (inch)

- $\leq .1181$ DIAMETER**
DC = +.0008/+0.0047
DCON = h_6
- $>.1181-.2362$ DIAMETER**
DC = +.00016/+0.00063
DCON = h_6
- $>.2362-.3937$ DIAMETER**
DC = +.00024/+0.00083
DCON = h_6
- $>.3937-.7087$ DIAMETER**
DC = +.00028/+0.00098
DCON = h_6
- $>.7087-1.1811$ DIAMETER**
DC = +.00031/+0.00114
DCON = h_6

TOLERANCES (mm)

- ≤ 3 DIAMETER**
DC = +0,002/+0,012
DCON = h_6
- $>3-6$ DIAMETER**
DC = +0,004/+0,016
DCON = h_6
- $>6-10$ DIAMETER**
DC = +0,006/+0,021
DCON = h_6
- $>10-18$ DIAMETER**
DC = +0,007/+0,025
DCON = h_6
- $>18-30$ DIAMETER**
DC = +0,008/+0,029
DCON = h_6

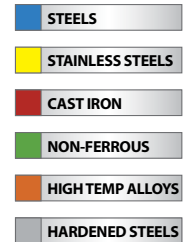

For patent information visit www.ksptpatents.com

continued on next page



FRACTIONAL & METRIC Series 136U

136U 2xD

FRACTIONAL & METRIC SERIES

DECIMAL DC	METRIC DC	FRACTIONAL/ LETTER/WIRE DC	inch & mm					SHANK LENGTH LS	EDP NO. Ti-NAMITE [®] -X (TX)
			SHANK DIAMETER DCON	OVERALL LENGTH OAL	FLUTE LENGTH LCF	USABLE LENGTH LU			
0.2480	6,300 mm		8,0	70,0	22,0	13,0	37,0	67109	
0.2500	6,350 mm	1/4 E #0	8,0	70,0	22,0	13,0	37,0	58511	
0.2520	6,400 mm		8,0	70,0	22,0	13,0	37,0	67110	
0.2559	6,500 mm		8,0	70,0	23,0	13,0	37,0	67111	
0.2570	6,528 mm	F	8,0	70,0	23,0	13,0	37,0	58512	
0.2598	6,600 mm		8,0	70,0	23,0	13,0	37,0	67112	
0.2638	6,700 mm		8,0	70,0	23,0	13,0	37,0	67113	
0.2656	6,746 mm	17/64	8,0	70,0	24,0	13,0	37,0	58513	
0.2677	6,800 mm		8,0	70,0	24,0	14,0	37,0	67114	
0.2717	6,900 mm		8,0	70,0	24,0	14,0	37,0	67115	
0.2720	6,909 mm	I	8,0	70,0	24,0	14,0	37,0	58514	
0.2756	7,000 mm		8,0	70,0	25,0	14,0	37,0	67116	
0.2795	7,100 mm		8,0	70,0	25,0	14,0	37,0	67117	
0.2812	7,142 mm	9/32	8,0	70,0	25,0	14,0	37,0	58515	
0.2835	7,200 mm		8,0	70,0	25,0	14,0	37,0	67118	
0.2854	7,250 mm		8,0	70,0	25,0	14,0	37,0	67119	
0.2874	7,300 mm		8,0	70,0	26,0	15,0	37,0	67120	
0.2913	7,400 mm		8,0	70,0	26,0	15,0	37,0	67121	
0.2953	7,500 mm		8,0	70,0	26,0	15,0	37,0	67122	
0.2969	7,541 mm	19/64	8,0	70,0	26,0	15,0	37,0	58516	
0.2992	7,600 mm		8,0	70,0	27,0	15,0	37,0	67123	
0.3031	7,700 mm		8,0	70,0	27,0	15,0	37,0	67124	
0.3071	7,800 mm		8,0	70,0	27,0	16,0	37,0	67125	
0.3110	7,900 mm		8,0	70,0	28,0	16,0	37,0	67126	
0.3125	7,938 mm	5/16	8,0	70,0	28,0	16,0	37,0	58517	
0.3150	8,000 mm		8,0	70,0	28,0	16,0	37,0	67127	
0.3189	8,100 mm		10,0	80,0	29,0	17,0	40,0	67128	
0.3228	8,200 mm		10,0	80,0	29,0	16,0	40,0	67129	
0.3268	8,300 mm		10,0	80,0	29,0	17,0	40,0	67130	
0.3281	8,334 mm	21/64	10,0	80,0	29,0	17,0	40,0	58518	
0.3307	8,400 mm		10,0	80,0	29,0	17,0	40,0	67131	
0.3320	8,433 mm	Q	10,0	80,0	30,0	17,0	40,0	58519	
0.3346	8,500 mm		10,0	80,0	30,0	17,0	40,0	67132	
0.3386	8,600 mm		10,0	80,0	30,0	17,0	40,0	67133	
0.3425	8,700 mm		10,0	80,0	30,0	17,0	40,0	67134	
0.3438	8,733 mm	11/32	10,0	80,0	31,0	17,0	40,0	58520	
0.3465	8,800 mm		10,0	80,0	31,0	18,0	40,0	67135	
0.3504	8,900 mm		10,0	80,0	31,0	18,0	40,0	67136	
0.3543	9,000 mm		10,0	80,0	31,0	18,0	40,0	67137	
0.3583	9,100 mm		10,0	80,0	32,0	18,0	40,0	67138	
0.3594	9,129 mm	23/64	10,0	80,0	32,0	18,0	40,0	58521	
0.3622	9,200 mm		10,0	80,0	32,0	18,0	40,0	67139	
0.3661	9,300 mm		10,0	80,0	33,0	19,0	40,0	67140	
0.3680	9,347 mm	U	10,0	80,0	33,0	19,0	40,0	58522	
0.3701	9,400 mm		10,0	80,0	33,0	19,0	40,0	67141	
0.3740	9,500 mm		10,0	80,0	33,0	19,0	40,0	67142	

CONTINUED

continued on next page

Series 136U 2xD | Fractional & Metric

FRACTIONAL & METRIC Series 136U

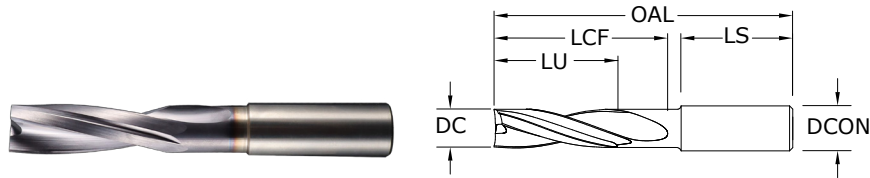

136U 2xD FRACTIONAL & METRIC SERIES

- 4-margin design improves accuracy and surface finish along with increased strength for aggressive drilling
- Specialized self-centering notched point eliminates the need for spot drilling decreasing thrust and deflection
- Engineered edge protection improves edge strength and reduces edge fatigue allowing for increased feed rates
- Recommended for materials ≤ 56 HRc (≤ 577 Bhn)

inch & mm								EDP NO.
DECIMAL DC	METRIC DC	FRACTIONAL/ LETTER/WIRE DC	SHANK DIAMETER DCON	OVERALL LENGTH OAL	FLUTE LENGTH LCF	USABLE LENGTH LU	SHANK LENGTH LS	Ti-NAMITE [®] -X (TX)
0.3750	9,525 mm	3/8	10,0	80,0	33,0	19,0	40,0	58523
0.3780	9,600 mm		10,0	80,0	34,0	19,0	40,0	67143
0.3819	9,700 mm		10,0	80,0	34,0	19,0	40,0	67144
0.3858	9,800 mm		10,0	80,0	34,0	20,0	40,0	67145
0.3898	9,900 mm		10,0	80,0	35,0	20,0	40,0	67146
0.3906	9,921 mm	25/64	10,0	80,0	35,0	20,0	40,0	58524
0.3937	10,000 mm		10,0	80,0	35,0	20,0	40,0	67147
0.3970	10,084 mm	X	12,0	90,0	36,0	21,0	43,0	58525
0.3976	10,100 mm		12,0	90,0	36,0	21,0	43,0	67148
0.4016	10,200 mm		12,0	90,0	36,0	20,0	43,0	67149
0.4040	10,262 mm	Y	12,0	90,0	36,0	21,0	43,0	58526
0.4055	10,300 mm		12,0	90,0	36,0	21,0	43,0	67150
0.4062	10,317 mm	13/32	12,0	90,0	36,0	21,0	43,0	58527
0.4094	10,400 mm		12,0	90,0	36,0	21,0	43,0	67151
0.4134	10,500 mm		12,0	90,0	37,0	21,0	43,0	67152
0.4173	10,600 mm		12,0	90,0	37,0	21,0	43,0	67153
0.4213	10,700 mm		12,0	90,0	37,0	21,0	43,0	67154
0.4219	10,716 mm	27/64	12,0	90,0	38,0	21,0	43,0	58528
0.4252	10,800 mm		12,0	90,0	38,0	22,0	43,0	67155
0.4291	10,900 mm		12,0	90,0	38,0	22,0	43,0	67156
0.4331	11,000 mm		12,0	90,0	39,0	22,0	43,0	67157
0.4370	11,100 mm		12,0	90,0	39,0	22,0	43,0	67158
0.4375	11,113 mm	7/16	12,0	90,0	39,0	22,0	43,0	58529
0.4409	11,200 mm		12,0	90,0	39,0	22,0	43,0	67159
0.4449	11,300 mm		12,0	90,0	40,0	23,0	43,0	67160
0.4488	11,400 mm		12,0	90,0	40,0	23,0	43,0	67161
0.4528	11,500 mm		12,0	90,0	40,0	23,0	43,0	67162
0.4531	11,509 mm	29/64	12,0	90,0	40,0	23,0	43,0	58530
0.4567	11,600 mm		12,0	90,0	41,0	23,0	43,0	67163
0.4606	11,700 mm		12,0	90,0	41,0	23,0	43,0	67164
0.4646	11,800 mm		12,0	90,0	41,0	24,0	43,0	67165
0.4685	11,900 mm		12,0	90,0	42,0	24,0	43,0	67166
0.4688	11,908 mm	15/32	12,0	90,0	42,0	24,0	43,0	58531
0.4724	12,000 mm		12,0	90,0	42,0	24,0	43,0	67167
0.4844	12,304 mm	31/64	14,0	100,0	43,0	25,0	46,0	58532
0.4921	12,500 mm		14,0	100,0	44,0	25,0	46,0	67168
0.5000	12,700 mm	1/2	14,0	100,0	44,0	25,0	46,0	58533
0.5039	12,800 mm		14,0	100,0	45,0	26,0	46,0	67169

continued on next page

TOLERANCES (inch)

- $\leq .1181$ DIAMETER**
DC = $+0.0008/+0.0047$
DCON = h_6
- $>.1181-.2362$ DIAMETER**
DC = $+0.0016/+0.0063$
DCON = h_6
- $>.2362-.3937$ DIAMETER**
DC = $+0.0024/+0.0083$
DCON = h_6
- $>.3937-.7087$ DIAMETER**
DC = $+0.0028/+0.0098$
DCON = h_6
- $>.7087-1.1811$ DIAMETER**
DC = $+0.0031/+0.0114$
DCON = h_6

TOLERANCES (mm)

- ≤ 3 DIAMETER**
DC = $+0,002/+0,012$
DCON = h_6
- $>3-6$ DIAMETER**
DC = $+0,004/+0,016$
DCON = h_6
- $>6-10$ DIAMETER**
DC = $+0,006/+0,021$
DCON = h_6
- $>10-18$ DIAMETER**
DC = $+0,007/+0,025$
DCON = h_6
- $>18-30$ DIAMETER**
DC = $+0,008/+0,029$
DCON = h_6

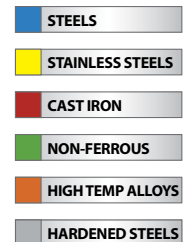

For patent information visit www.ksptpatents.com



FRACTIONAL & METRIC Series 136U

136U 2xD

FRACTIONAL & METRIC SERIES

DECIMAL DC	METRIC DC	inch & mm						EDP NO.
		FRACTIONAL/ LETTER/WIRE DC	SHANK DIAMETER DCON	OVERALL LENGTH OAL	FLUTE LENGTH LCF	USABLE LENGTH LU	SHANK LENGTH LS	Ti-NAMITE [®] -X (TX)
0.5118	13,000 mm		14,0	100,0	45,0	26,0	46,0	67170
0.5156	13,096 mm	33/64	14,0	100,0	46,0	26,0	46,0	58534
0.5312	13,492 mm	17/32	14,0	100,0	47,0	27,0	46,0	58535
0.5315	13,500 mm		14,0	100,0	47,0	27,0	46,0	67171
0.5469	13,891 mm	35/64	14,0	100,0	49,0	28,0	46,0	58536
0.5512	14,000 mm		14,0	100,0	49,0	28,0	46,0	67172
0.5625	14,288 mm	9/16	16,0	110,0	50,0	29,0	49,0	58537
0.5709	14,500 mm		16,0	110,0	51,0	29,0	49,0	67173
0.5781	14,684 mm	37/64	16,0	110,0	51,0	29,0	49,0	58538
0.5906	15,000 mm		16,0	110,0	53,0	30,0	49,0	67174
0.5938	15,083 mm	19/32	16,0	110,0	53,0	30,0	49,0	58539
0.6094	15,479 mm	39/64	16,0	110,0	54,0	31,0	49,0	58540
0.6102	15,500 mm		16,0	110,0	54,0	31,0	49,0	67175
0.6250	15,875 mm	5/8	16,0	110,0	56,0	32,0	49,0	58541
0.6299	16,000 mm		16,0	110,0	56,0	32,0	49,0	67176
0.6406	16,271 mm	41/64	18,0	125,0	57,0	33,0	57,0	58542
0.6496	16,500 mm		18,0	125,0	58,0	33,0	57,0	67177
0.6562	16,667 mm	21/32	18,0	125,0	58,0	33,0	57,0	58543
0.6693	17,000 mm		18,0	125,0	60,0	34,0	57,0	67178
0.6719	17,066 mm	43/64	18,0	125,0	60,0	34,0	57,0	58544
0.6875	17,463 mm	11/16	18,0	125,0	61,0	35,0	57,0	58545
0.6890	17,500 mm		18,0	125,0	61,0	35,0	57,0	67179
0.7031	17,859 mm	45/64	18,0	125,0	63,0	36,0	57,0	58546
0.7087	18,000 mm		18,0	125,0	63,0	36,0	57,0	67180
0.7188	18,258 mm	23/32	20,0	135,0	64,0	37,0	60,0	58547
0.7283	18,500 mm		20,0	135,0	65,0	37,0	60,0	67181
0.7344	18,654 mm	47/64	20,0	135,0	65,0	37,0	60,0	58548
0.7480	19,000 mm		20,0	135,0	66,0	38,0	60,0	67182
0.7500	19,050 mm	3/4	20,0	135,0	67,0	38,0	60,0	58549
0.7656	19,446 mm	49/64	20,0	135,0	68,0	39,0	60,0	58550
0.7677	19,500 mm		20,0	135,0	68,0	39,0	60,0	67183
0.7812	19,842 mm	25/32	20,0	135,0	69,0	40,0	60,0	58551
0.7874	20,000 mm		20,0	135,0	70,0	40,0	60,0	67184
0.7969	20,241 mm	51/64	22,0	145,0	71,0	40,0	68,0	58552
0.8071	20,500 mm		22,0	145,0	72,0	41,0	68,0	67185
0.8125	20,638 mm	13/16	22,0	145,0	72,0	41,0	68,0	58553

CONTINUED

Series 136U 2xD | Fractional & Metric



Series 136U & 146U Speed & Feed Recommendations

Series 146U, 136U Fractional	Hardness	Vc (sfm)	DC • in									
			1/16	1/8	1/4	3/8	1/2	5/8	3/4	13/16		
CARBON STEELS 1018, 1040, 1080, 1090, 10L50, 1140, 1212, 12L15, 1525, 1536	≤ 175 Bhn or ≤ 7 HRc	285 (228-342)	RPM	17419	8710	4355	2903	2177	1742	1452	1340	
			Fr	0.0016	0.0031	0.0062	0.0093	0.0124	0.0155	0.0186	0.0202	
			Feed (ipm)	27.0	27.0	27.0	27.0	27.0	27.0	27.0	27.0	
	≤ 275 Bhn or ≤ 28 HRc	255 (204-306)	RPM	15586	7793	3896	2598	1948	1559	1299	1199	
			Fr	0.0013	0.0027	0.0054	0.0081	0.0108	0.0135	0.0162	0.0175	
			Feed (ipm)	21.0	21.0	21.0	21.0	21.0	21.0	21.0	21.0	
	≤ 425 Bhn or ≤ 45 HRc	145 (116-174)	RPM	8862	4431	2216	1477	1108	886	739	682	
			Fr	0.0011	0.0023	0.0045	0.0068	0.0090	0.0113	0.0135	0.0147	
			Feed (ipm)	10.0	10.0	10.0	10.0	10.0	10.0	10.0	10.0	
ALLOY STEELS 4140, 4150, 4320, 5120, 5150, 8630, 86L20, 50100	≤ 275 Bhn or ≤ 28 HRc	220 (176-264)	RPM	13446	6723	3362	2241	1681	1345	1121	1034	
			Fr	0.0015	0.0030	0.0059	0.0089	0.0119	0.0149	0.0178	0.0193	
			Feed (ipm)	20.0	20.0	20.0	20.0	20.0	20.0	20.0	20.0	
	≤ 375 Bhn or ≤ 40 HRc	135 (108-162)	RPM	8251	4126	2063	1375	1031	825	688	635	
			Fr	0.0013	0.0027	0.0053	0.0080	0.0107	0.0133	0.0160	0.0173	
			Feed (ipm)	11.0	11.0	11.0	11.0	11.0	11.0	11.0	11.0	
TOOL STEELS A2, D2, H13, L2, M2, P20, S7, T15, W2	≤ 200 Bhn or ≤ 13 HRc	125 (100-150)	RPM	7640	3820	1910	1273	955	764	637	588	
			Fr	0.0012	0.0025	0.0050	0.0075	0.0099	0.0124	0.0149	0.0162	
			Feed (ipm)	9.5	9.5	9.5	9.5	9.5	9.5	9.5	9.5	
	≤ 375 Bhn or ≤ 40 HRc	90 (72-108)	RPM	5501	2750	1375	917	688	550	458	423	
			Fr	0.0005	0.0011	0.0022	0.0033	0.0044	0.0055	0.0065	0.0071	
			Feed (ipm)	3.0	3.0	3.0	3.0	3.0	3.0	3.0	3.0	
STAINLESS STEELS (FREE MACHINING) 303, 416, 420F, 430F, 440F	≤ 185 Bhn or ≤ 9 HRc	265 (212-318)	RPM	16197	8098	4049	2699	2025	1620	1350	1246	
			Fr	0.0008	0.0016	0.0032	0.0048	0.0064	0.0080	0.0096	0.0104	
			Feed (ipm)	13.0	13.0	13.0	13.0	13.0	13.0	13.0	13.0	
		≤ 275 Bhn or ≤ 28 HRc	170 (136-204)	RPM	10390	5195	2598	1732	1299	1039	866	799
				Fr	0.0006	0.0013	0.0025	0.0038	0.0050	0.0063	0.0075	0.0081
				Feed (ipm)	6.5	6.5	6.5	6.5	6.5	6.5	6.5	6.5
STAINLESS STEELS (DIFFICULT) 304, 316, 321, 13-8 PH, 15-5PH, 17-4 PH, Custom 450	≤ 275 Bhn or ≤ 28 HRc	130 (104-156)	RPM	7946	3973	1986	1324	993	795	662	611	
			Fr	0.0006	0.0013	0.0025	0.0038	0.0050	0.0063	0.0076	0.0082	
			Feed (ipm)	5.0	5.0	5.0	5.0	5.0	5.0	5.0	5.0	
		≤ 375 Bhn or ≤ 40 HRc	95 (76-114)	RPM	5806	2903	1452	968	726	581	484	447
				Fr	0.0006	0.0011	0.0023	0.0034	0.0045	0.0057	0.0068	0.0074
				Feed (ipm)	3.3	3.3	3.3	3.3	3.3	3.3	3.3	3.3
GRAY CAST IRONS	≤ 220 Bhn or ≤ 19 HRc	250 (200-300)	RPM	15280	7640	3820	2547	1910	1528	1273	1175	
			Fr	0.0016	0.0031	0.0063	0.0094	0.0126	0.0157	0.0188	0.0204	
			Feed (ipm)	24.0	24.0	24.0	24.0	24.0	24.0	24.0	24.0	
DUCTILE CAST IRONS	≤ 260 Bhn or ≤ 26 HRc	220 (176-264)	RPM	13446	6723	3362	2241	1681	1345	1121	1034	
			Fr	0.0015	0.0030	0.0059	0.0089	0.0119	0.0149	0.0178	0.0193	
			Feed (ipm)	20.0	20.0	20.0	20.0	20.0	20.0	20.0	20.0	

continued on next page

	Series 146U, 136U Fractional	Hardness	Vc (sfm)	DC • in								
				1/16	1/8	1/4	3/8	1/2	5/8	3/4	13/16	
N	ALUMINUM ALLOYS (WROUGHT) 2024, 6061, 7075	≤ 150 Bhn or 88 HRb	475	RPM	29032	14516	7258	4839	3629	2903	2419	2233
			(380-570)	Fr	0.0016	0.0031	0.0062	0.0093	0.0124	0.0155	0.0186	0.0202
				Feed (ipm)	45.0	45.0	45.0	45.0	45.0	45.0	45.0	45.0
	ALUMINUM ALLOYS (CAST) A356, A380, 390	≤ 140 Bhn or 3 HRc	380	RPM	23226	11613	5806	3871	2903	2323	1935	1787
			(304-456)	Fr	0.0014	0.0028	0.0055	0.0083	0.0110	0.0138	0.0165	0.0179
				Feed (ipm)	32.0	32.0	32.0	32.0	32.0	32.0	32.0	32.0
S	TITANIUM ALLOYS Pure Titanium, Ti6Al4V, Ti6Al2Sn4Zr2Mo, Ti4Al4Mo2Sn0.5Si, Ti-6Al4V	≤ 275 Bhn or 28 HRc	175	RPM	10696	5348	2674	1783	1337	1070	891	823
			(140-210)	Fr	0.0007	0.0014	0.0028	0.0042	0.0055	0.0069	0.0083	0.0090
				Feed (ipm)	7.4	7.4	7.4	7.4	7.4	7.4	7.4	7.4
		≤ 350 Bhn or 38 HRc	130	RPM	7946	3973	1986	1324	993	795	662	611
			(104-156)	Fr	0.0006	0.0013	0.0025	0.0038	0.0050	0.0063	0.0076	0.0082
				Feed (ipm)	5.0	5.0	5.0	5.0	5.0	5.0	5.0	5.0
		≤ 440 Bhn or 47 HRc	70	RPM	4278	2139	1070	713	535	428	357	329
			(56-84)	Fr	0.0005	0.0009	0.0019	0.0028	0.0037	0.0047	0.0056	0.0061
				Feed (ipm)	2.0	2.0	2.0	2.0	2.0	2.0	2.0	2.0
H	Alloy Steels 4140, 4150, 4320, 5120, 5150, 8630, 86L20, 50100	≤ 450 Bhn or 48 HRc	95	RPM	5806	2903	1452	968	726	581	484	447
			(76-114)	Fr	0.0008	0.0016	0.0031	0.0047	0.0062	0.0078	0.0093	0.0101
				Feed (ipm)	4.5	4.5	4.5	4.5	4.5	4.5	4.5	4.5
	TOOL STEELS A2, D2, H13, L2, M2, P20, S7, T15, W2	≤ 475 Bhn or 50 HRc	80	RPM	4890	2445	1222	815	611	489	407	376
			(64-96)	Fr	0.0007	0.0014	0.0029	0.0043	0.0057	0.0072	0.0086	0.0093
				Feed (ipm)	3.5	3.5	3.5	3.5	3.5	3.5	3.5	3.5

reduce rates when material is harder than listed, when drilling conditions are not optimum, or coolant is not available
 rates shown are for drilling into a flat surface and should be lowered using the reduction multiplier when the workpiece is angled or curved
 reduce rates 10 to 20 percent when using drills without internal coolant
 always use the shortest overhang possible
 longer drills may require a spot drill operation to avoid walking on entry
 internal coolant required in ISO S and M material groups or when drilling depth exceeds 3xD
 Bhn (Brinell) HRc (Rockwell C) HRb (Rockwell B)
 $rpm = Vc \times 3.82 / DC$
 $ipm = Fr \times rpm$
 speed and feed for materials harder than listed
 refer to the SGS Tool Wizard® for complete technical information (www.kyocera-sgstoool.com)

angle °	reduction multiplier	
	speed x	feed x
up to 30	1.0	0.6
over 30	0.7	0.4

Series 146U • Series 136U



Series 136U & 146U Speed & Feed Recommendations

Series 146U, 136U Metric	Hardness	Vc (m/mm)	DC • mm									
			1.5	3	6	8	10	12	16	20		
CARBON STEELS 1018, 1040, 1080, 1090, 10L50, 1140, 1212, 12L15, 1525, 1536	≤ 175 Bhn or ≤ 7 HRc	87	RPM	18419	9209	4605	3454	2763	2302	1727	1381	
		(69-104)	Fr	0.037	0.074	0.149	0.199	0.248	0.298	0.397	0.496	
			Feed (mm/min)	686	686	686	686	686	686	686	686	
	≤ 275 Bhn or ≤ 28 HRc	78	RPM	16480	8240	4120	3090	2472	2060	1545	1236	
		(62-93)	Fr	0.032	0.065	0.129	0.173	0.216	0.259	0.345	0.432	
			Feed (mm/min)	533	533	533	533	533	533	533	533	
	≤ 425 Bhn or ≤ 45 HRc	44	RPM	9371	4686	2343	1757	1406	1171	879	703	
		(35-53)	Fr	0.027	0.054	0.108	0.145	0.181	0.217	0.289	0.361	
			Feed (mm/min)	254	254	254	254	254	254	254	254	
	ALLOY STEELS 4140, 4150, 4320, 5120, 5150, 8630, 86L20, 50100	≤ 275 Bhn or ≤ 28 HRc	67	RPM	14218	7109	3555	2666	2133	1777	1333	1066
			(54-80)	Fr	0.036	0.071	0.143	0.191	0.238	0.286	0.381	0.476
				Feed (mm/min)	508	508	508	508	508	508	508	508
≤ 375 Bhn or ≤ 40 HRc		41	RPM	8725	4362	2181	1636	1309	1091	818	654	
		(33-49)	Fr	0.032	0.064	0.128	0.171	0.213	0.256	0.342	0.427	
			Feed (mm/min)	279	279	279	279	279	279	279	279	
TOOL STEELS A2, D2, H13, L2, M2, P20, S7, T15, W2	≤ 200 Bhn or ≤ 13 HRc	38	RPM	8078	4039	2020	1515	1212	1010	757	606	
		(30-46)	Fr	0.030	0.060	0.119	0.159	0.199	0.239	0.319	0.398	
			Feed (mm/min)	241	241	241	241	241	241	241	241	
	≤ 375 Bhn or ≤ 40 HRc	27	RPM	5816	2908	1454	1091	872	727	545	436	
		(22-33)	Fr	0.013	0.026	0.052	0.070	0.087	0.105	0.140	0.175	
			Feed (mm/min)	76	76	76	76	76	76	76	76	
STAINLESS STEELS (FREE MACHINING) 303, 416, 420F, 430F, 440F	≤ 185 Bhn or ≤ 9 HRc	81	RPM	17126	8563	4282	3211	2569	2141	1606	1284	
		(65-97)	Fr	0.019	0.039	0.077	0.103	0.129	0.154	0.206	0.257	
			Feed (mm/min)	330	330	330	330	330	330	330	330	
	≤ 275 Bhn or ≤ 28 HRc	52	RPM	10987	5493	2747	2060	1648	1373	1030	824	
		(41-62)	Fr	0.015	0.030	0.060	0.080	0.100	0.120	0.160	0.200	
			Feed (mm/min)	165	165	165	165	165	165	165	165	
STAINLESS STEELS (DIFFICULT) 304, 316, 321, 13-8 PH, 15-5PH, 17-4 PH, Custom 450	≤ 275 Bhn or ≤ 28 HRc	40	RPM	8402	4201	2100	1575	1260	1050	788	630	
		(32-48)	Fr	0.015	0.030	0.060	0.081	0.101	0.121	0.161	0.202	
			Feed (mm/min)	127	127	127	127	127	127	127	127	
	≤ 375 Bhn or ≤ 40 HRc	29	RPM	6140	3070	1535	1151	921	767	576	460	
		(23-35)	Fr	0.014	0.027	0.055	0.073	0.091	0.109	0.146	0.182	
			Feed (mm/min)	84	84	84	84	84	84	84	84	
GRAY CAST IRONS	≤ 220 Bhn or ≤ 19 HRc	76	RPM	16157	8078	4039	3029	2424	2020	1515	1212	
		(61-91)	Fr	0.038	0.075	0.151	0.201	0.252	0.302	0.402	0.503	
			Feed (mm/min)	610	610	610	610	610	610	610	610	
	DUCTILE CAST IRONS	≤ 260 Bhn or ≤ 26 HRc	67	RPM	14218	7109	3555	2666	2133	1777	1333	1066
			(54-80)	Fr	0.036	0.071	0.143	0.191	0.238	0.286	0.381	0.476
				Feed (mm/min)	508	508	508	508	508	508	508	508

continued on next page

Series 146U, 136U Metric	Hardness	Vc (m/mm)		DC • mm								
				1.5	3	6	8	10	12	16	20	
N	ALUMINUM ALLOYS (WROUGHT) 2024, 6061, 7075	≤ 150 Bhn	145	RPM	30698	15349	7675	5756	4605	3837	2878	2302
		or	(116-174)	Fr	0.037	0.074	0.149	0.199	0.248	0.298	0.397	0.496
		≤ 88 HRb		Feed (mm/min)	1143	1143	1143	1143	1143	1143	1143	1143
	ALUMINUM ALLOYS (CAST) A356, A380, 390	≤ 140 Bhn	116	RPM	24559	12279	6140	4605	3684	3070	2302	1842
		or	(93-139)	Fr	0.033	0.066	0.132	0.177	0.221	0.265	0.353	0.441
		≤ 3 HRc		Feed (mm/min)	813	813	813	813	813	813	813	813
S	TITANIUM ALLOYS Pure Titanium, Ti6Al4V, Ti6Al2Sn4Zr2Mo, Ti4Al4Mo2Sn0.5Si, Ti-6Al4V	≤ 275 Bhn	53	RPM	11310	5655	2827	2121	1696	1414	1060	848
		or	(43-64)	Fr	0.017	0.033	0.066	0.089	0.111	0.133	0.177	0.222
		≤ 28 HRc		Feed (mm/min)	188	188	188	188	188	188	188	188
		≤ 350 Bhn	40	RPM	8402	4201	2100	1575	1260	1050	788	630
		or	(32-48)	Fr	0.015	0.030	0.060	0.081	0.101	0.121	0.161	0.202
		≤ 38 HRc		Feed (mm/min)	127	127	127	127	127	127	127	127
		≤ 440 Bhn	21	RPM	4524	2262	1131	848	679	565	424	339
		or	(17-26)	Fr	0.011	0.022	0.045	0.060	0.075	0.090	0.120	0.150
		≤ 47 HRc		Feed (mm/min)	51	51	51	51	51	51	51	51
H	Alloy Steels 4140, 4150, 4320, 5120, 5150, 8630, 86L20, 50100	≤ 450 Bhn	29	RPM	6140	3070	1535	1151	921	767	576	460
		or	(23-35)	Fr	0.019	0.037	0.074	0.099	0.124	0.149	0.199	0.248
		≤ 48 HRc		Feed (mm/min)	114	114	114	114	114	114	114	114
	TOOL STEELS A2, D2, H13, L2, M2, P20, S7, T15, W2	≤ 475 Bhn	24	RPM	5170	2585	1293	969	776	646	485	388
		or	(20-29)	Fr	0.017	0.034	0.069	0.092	0.115	0.138	0.183	0.229
		≤ 50 HRc		Feed (mm/min)	89	89	89	89	89	89	89	89

reduce rates when material is harder than listed, when drilling conditions are not optimum, or coolant is not available
 rates shown are for drilling into a flat surface and should be lowered using the reduction multiplier when the workpiece is angled or curved
 reduce rates 10 to 20 percent when using drills without internal coolant
 always use the shortest overhang possible
 longer drills may require a spot drill operation to avoid walking on entry
 internal coolant required in ISO S and M material groups or when drilling depth exceeds 3xD
 Bhn (Brinell) HRc (Rockwell C) HRb (Rockwell B)
 $rpm = (Vc \times 1000) / (DC \times 3.14)$
 $mm/min = Fr \times rpm$
 speed and feed for materials harder than listed
 refer to the SGS Tool Wizard® for complete technical information (www.kyocera-sgstool.com)

angle °	reduction multiplier	
	speed x	feed x
up to 30	1.0	0.6
over 30	0.7	0.4

SOLUTIONS AROUND THE GLOBE

KYOCERA SGS Precision Tools is an ISO 9001:2015 Certified leader of round solid carbide cutting tool technology for the aerospace, metalworking, and automotive industries with manufacturing sites in the United States and United Kingdom. Our global network of Sales Representatives, Industrial Distributors, and Agents blanket the world selling into more than 60 countries.

LEADERS IN SOLID CARBIDE TOOL TECHNOLOGY

Brand names such as Z-Carb, S-Carb®, V-Carb, Hi-PerCarb®, Multi-Carb have become synonymous with high performance tooling in the machining and metalworking industry.

We're proud to have pioneered some of the world's most advanced cutting technology right here on our Northeast Ohio manufacturing campus. KSPT high performance end mills, drills and routers are increasing productivity and reducing cost around the world.

EXCEEDING CUSTOMER EXPECTATIONS

As the world's manufacturing needs change, so does KSPT. It's all about the science, starting with our lab inspected substrate materials to our tool designs and coatings. Our exceptional team of researchers, engineers, and machinists are dedicated to developing the absolute best and delivering the ultimate Value at the Spindle®.

- Incredible batch-to-batch consistency
- Metallurgical lab dedicated to testing and rigorous quality control
- ISO 9001:2015 Certified quality procedures
- Patented geometries that extend tool life, reduce chatter, cut cycle times, and improve part quality—even at extreme parameters
- Specialists in extreme and demanding product applications
- Comprehensive tooling services
- Experienced Field Sales Engineers who work to optimize a tool for your particular application
- Dedicated multi-lingual customer service representatives

SGS PRODUCTS ARE DISTRIBUTED BY:



www.kyocera-sgstool.com



UNITED STATES OF AMERICA

KYOCERA SGS Precision Tools
150 Marc Drive
Cuyahoga Falls, Ohio 44223 U.S.A.
customer service -
US and Canada: (330) 686-5700
fax - US & Canada: (800) 447-4017
international fax: (330) 686-2146
orders: sales@kyocera-sgstool.com
web: www.kyocera-sgstool.com

VALUE AT THE SPINDLE®

UNITED KINGDOM

KYOCERA SGS Precision Tools Europe Ltd.
10 Ashville Way
Wokingham, Berkshire
RG41 2PL England
phone: (44) 1189-795-200
fax: (44) 1189-795-295
e-mail: SalesEU@kyocera-sgstool.com
web: www.kyocera-sgstool.co.uk

JAPAN

KYOCERA Corporation
International Sales Dept.
6 Takeda Tobadono-cho,
Fushimi-ku, Kyoto 612-8501, Japan
phone: +81-75-604-3473
fax: +81-75-604-3472
web: global.kyocera.com/prdct/tool/index.html

COMMERCIAL OFFICES

EASTERN EUROPE

SINTCOM
Sintcom Tools
95 Arsenalski Blvd.
1421 Sofia, Bulgaria
phone: (359) 283-64421
fax: (359) 286-52493
e-mail: sintcom@sintcomtools.com

FRANCE

DOGA Usinage
8, Avenue Gutenberg CS 50510
78317 Maurepas Cedex - France
phone: +33 1 30 66 41 41
e-mail: usinage-outils@dogaf.fr

GERMANY

KADIGO Tool Systems GmbH
Walramster. 27
65510 Idstein, Germany
phone: +49 8376 9287238
fax: +49 8376 9287237
e-mail: info@kadigo-ts.com

INDIA

KYOCERA Asia Pacific India Pvt. Ltd
Plot No.51, Phase-I,
Udyog Vihar Gurgaon 122016,
Haryana, India
phone: +91-124-4025022
fax: +91-124-4025001

KOREA

KYOCERA Precision Tools Korea Co., Ltd.
2LT 69BL, Namdong Industrial Estate,
638-1, Kozan-Dong, Namdong Incheon,
Korea
phone: +82-32-821-8365
fax: +82-32-821-8369
web: www.kptk.co.kr/

POLAND

KYOCERA SGS Precision Tools
phone: +48 530 432 002
e-mail: SalesEU@kyocera-sgstool.com

RUSSIA

HALTEC
phone: (7) 495-252-05-00
e-mail: info@haltec.ru
web: www.haltec.ru

SPAIN

KYOCERA SGS Precision Tools IBERICA
e-mail: SalesEU@kyocera-sgstool.com

THAILAND

KYOCERA Asia Pacific (Thailand) Co., Ltd.
1 Capital Work Place Building
7th Floor, Soi Chamchan, Sukhumvit
55 Road, Klongton Nua, Wattana,
Bangkok 10110, Thailand
phone: +66-2-030-6688
fax: +66-2-030-6600

SINGAPORE

KYOCERA Asia Pacific Pte. Ltd.
298 Tiong Bahru Road, #13-03/05 Central Plaza,
Singapore 168730
phone: +65-6373-6700
fax: +65-6271-0600
web: asia.kyocera.com/products/cuttingtools/index.html

CHINA

KYOCERA (China) Sales & Trading Corporation
Room 140, Building A3, Daning Central Square,
No. 700 Wanrong Road,
Zhabei District, Shanghai, 200072,
P.R. China
phone: +86-21-3660-7711
fax: +86-21-568-6200
web: www.kyocera.com.cn/prdct/cuttingtool

